



Surge Protection

Catalogue valid as of August 1, 2020



DEHNcombo

32



- Prewired type 1 + type 2 combined lightning current and surge arrester for use in photovoltaic generator circuits
- Approved fault-resistant Y circuit prevents damage to the surge protective device in case of insulation faults in the generator circuit
- Rated voltage is the same for all modes of protection and, therefore, the arrester can also be used in earthed systems

DEHNguard modular ACI

52



- New technology "Advanced Circuit Interruption" (ACI) integrated in the protection module, consists of a switch / spark gap combination
- Due to ACI technology no external backup fuse required
- Small connection cross-sections (6 mm² Cu) absolutely sufficient
- TOV withstand also at 440 V (AC)

DEHNcord 3P TT 275 FM

78



- Compact three-phase arrester for all installation systems
- Mounted on DIN rails or, in confined spaces, using screw lugs
- Visual fault indication
- Compact design

DEHNdetect

117



- Lightning current measuring system to prevent subsequent damage in wind turbines
- Reduction of maintenance / repair costs
- Reduction of downtime

BLITZDUCTORconnect – Modular

156



- Combined lightning current and surge arrester in modular design
- With push-in connection technology and disconnection function
- With vibration-proof secR module locking
- Integrated LifeCheck and visual status indication

BLITZDUCTORconnect – Compact

182



- Combined lightning current and surge arrester in a compact enclosure
- With push-in connection technology
- Integrated LifeCheck and visual status indication

DEHNbox TC B 180

220



- Compact surge arrester in a surface-mounted plastic enclosure
- High-performance protection of telecommunications interfaces at the boundaries from LPZ 0_A to 2
- Suitable for wall mounting, IP 20

Condition Monitoring System LifeCheck for BLITZDUCTORconnect

236



- Two-part monitoring unit in a compact enclosure
- Condition monitoring of arresters of the BLITZDUCTORconnect series with integrated LifeCheck
- Quick and easy installation and commissioning (without addressing arresters)
- Remote signalling via floating remote signalling contact (nc)



Foreword	3
New Products	Cover
Our Promise – DEHN protects.	3
DEHN – International	4
Planned Safety	5
Terms and Definitions / Definition of Symbols	9
Protection Solutions and Product Recommendations for Buildings	14

Services	13
DEHNselect SPD Tool – Planning of internal Lightning Protection and Surge Protection	13



Surge Protection for Power Supply Systems	Red / Line	17
Combined Arresters – Type 1 + Type 2		20
Lightning Current Arresters – Type 1		33
N-PE Lightning Current Arresters		57
Surge Arresters – Type 2		50
Surge Arresters – Type 3		103
Measuring Devices and Accessories		117
Outdated Products		128



Surge Protection for Information Technology Systems	Yellow / Line	129
Selection Guide according to Interface/Signal		135
Pluggable SPDs – DIN Rail Mounted		155
Compact SPDs – DIN Rail Mounted		181
SPDs for LSA Technology		195
SPDs for Field Devices		205
SPDs for Telecommunication and Data Networks		211
SPDs for Building Systems		215
SPDs for Coaxial Connection		221
SPDs for SUB-D Connection		227
Shield Connection Systems and Enclosures		229
Measuring and Test Devices		235
Outdated Products		244



Lightning Equipotential Bonding	245
Isolating Spark Gaps	246
Voltage Controlled Short Circuiting Device VCSD	251
Ex Pipe Clamps	253
Voltage Limiting Devices	255
Equipotential Bonding	257

Index	265
DEHN – informative / DEHNacademy – E-Learning / Notes	265
Publications of the DEHNgroup / References	266
Part No. Index / Type Index	269
Notes	279
Key Words	280

Surge Protection Main Catalogue valid as of August 1, 2020

This catalogue replaces the Surge Protection Main Catalogue 2018.

We reserve the right to introduce changes in configuration and technology, dimensions, weights and materials within the scope of technical progress. Illustrations are not binding. We accept no liability for misprints, modifications and errors. Any reproduction of this catalogue, as a whole or in parts, is only allowed upon approval of DEHN.



Our promise



"We are a reliable partner for our customers and employees."

Dr Philipp Dehn
Chief Executive Officer

DEHN protects.

Dear business associates,

Our family-run business stands for safety and pioneering spirit in all matters of lightning and surge protection and safety equipment. Increasingly complex technical innovations and networks require enhanced protection.

We offer you the added value of readily available protective components, equipment, solutions and services of consistently high quality. You can rely on us, your worldwide partner for lightning and surge protection and safety equipment, to provide the best possible service.

We think ahead and ensure that the solutions we find with you today are also fit to meet the requirements of tomorrow. We invest in the future to give you a real competitive edge, e.g. our high-voltage-resistant insulated down conductor, the HVI Conductor, which is tailored to your applications; our ACI (Advanced Circuit Interruption), an innovative surge protection technology; or our sophisticated safety equipment. We are currently active in the field of occupational safety with high-pressure water jets and have already designed a completely new protective overall.

With heart and mind, passion and pioneering spirit, we drive forward developments in surge and lightning protection and safety equipment.

Digital transformation touches all aspects of our lives. We want to be your partner when it comes to protecting trend-setting smart energy and data solutions because all intelligent components have one thing in common: the sensitive "smart" electronics need protecting against the effects of lightning and surges. This applies to all electrically conductive systems, i.e. both power technology and information and communications technology. Let us combine our products, services and expertise with your protection requirements to create a tangible benefit for you and for us. We want to create a safer environment for you with new protection solutions to fit the continuously developing technology.

Take advantage of what we have on offer in terms of lightning and surge protection and safety equipment and help us to make the world just that little bit safer. I look forward to your interest and the chance to work with you!

Your

Dr Philipp Dehn



"Our customers are the focal point of our activities."

Helmut Pusch
Chief Sales Officer

Shared success

Our goal is to combine our products, solutions and expertise in such a way that the benefits are tangible, both for you and us. DEHN provides intelligent and sustainable protective solutions to meet your current and future requirements. We are your fair and reliable global partner. On- and offline we help you by providing information and comprehensive support. Strong sales teams, a network of 20 foreign subsidiaries and representative offices, and more than 70 sales partners worldwide are at your side for this purpose. We are particularly committed to imparting knowledge. We pass on our practical expertise on products and solutions through the hundreds of seminars, workshops, training sessions and conferences held annually and, not least, through our book the 'Lightning Protection Guide'. You, the customer, profit from our solutions and keep your finger on the pulse of time in terms of future protection solutions and requirements. Let us work together to make the increasingly complex and digital world just that little bit safer.

Your

Helmut Pusch

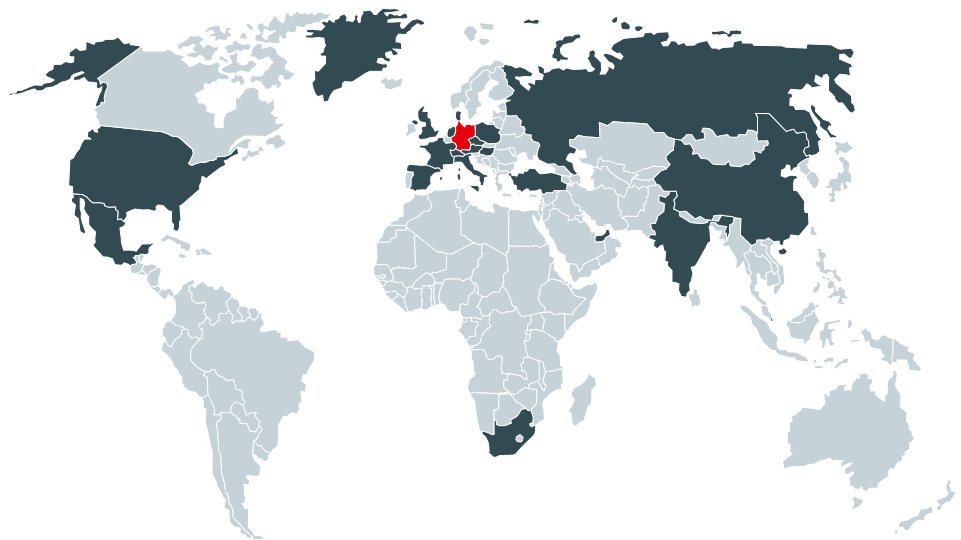

DEHN SE + Co KG

Customer Service Center

Customer Service
sales@dehn.de
Phone +49 9181 906-1547
Fax +49 9181 906-1444

Technical Support
itss@dehn.de
Phone +49 9181 906-1774
Fax +49 9181 906-1444

Subsidiaries and Representative Offices

Austria:	DEHN AUSTRIA GmbH	www.dehn.at
China:	DEHN Surge Protection (Shanghai) Co. Ltd.	www.dehn.cn
Czech Republic:	DEHN s.r.o.	www.dehn.cz
Denmark:	DESITEK A/S	www.desitek.dk
France:	DEHN FRANCE S.à.r.l.	www.dehn.fr
Great Britain:	DEHN (U.K.) LTD.	www.dehn.co.uk
Hungary:	DEHN office Budapest	www.dehn.hu
India:	DEHN INDIA Pvt. Ltd.	www.dehn.in
Italy:	DEHN ITALIA S.p.A.	www.dehn.it
Mexico:	DEHN PROTECTION MÉXICO, S.A. de C.V.	www.dehn.mx
Netherlands:	DEHN NEDERLAND B.V.	www.dehn.nl
Poland:	DEHN POLSKA Sp. z o.o.	www.dehn.pl
Russia:	OOO DEHN RUS	www.dehn-ru.com
Singapore:	DEHN (SEA) PTE. LTD.	www.dehn.sg
South Africa:	DEHN AFRICA (Pty) Ltd.	www.dehn-africa.com
Spain:	DEHN IBÉRICA Protecciones Eléctricas, S.A. Unipersonal	www.dehn.es
Switzerland:	ELVATEC AG	www.elvatec.ch
Turkey:	DEHN office Istanbul	www.dehn.com.tr
United Arab Emirates:	DEHN MIDDLE EAST FZE	www.dehn.ae
USA:	DEHN Inc.	www.dehn-usa.com

Sales activities in more than 70 countries worldwide

You can find your current local contact person online at:
<http://www.dehn-international.com/en/contact>

Failure of technical installations and systems in residential and functional buildings is very unpleasant and expensive. Therefore, faultless operation of devices must be ensured both during normal operation and thunderstorms. The number of annually registered lightning activities in Germany has remained at a constantly high level over many years. The damage statistics of insurance companies clearly show that there are deficits in terms of lightning and surge protection measures both in the private and commercial sector (Figure 1).

With a professional approach, suitable protective measures can be implemented. The lightning protection zone concept, for example, enables planners, installers and operators of buildings and installations to consider, implement and monitor various protective measures. In this way, all relevant devices, equipment and systems can be reliably protected at an economically justifiable cost.

Sources of interference

Surges occurring during a thunderstorm are caused by direct/nearby lightning strikes or remote lightning strikes (Figure 2 and Figure 3). Direct or nearby lightning strikes are lightning strikes to a building, its surroundings or electrically conductive systems entering the building (e.g. low-voltage supply, telecommunication and data lines). The resulting impulse currents and impulse voltages as well as the associated electromagnetic field are particularly dangerous for the devices and installations to be protected with regard to the amplitude and energy content involved. In case of a direct or nearby lightning strike, surges are caused by the voltage drop at the conventional earthing impedance R_{st} and the resulting potential rise of the building in relation to the remote earth (Figure 3, case 2). This represents the highest load for electrical installations in buildings.

The characteristic parameters of the impulse current that flows (peak value, rate of current rise, charge, specific energy) can be described by the 10/350 μs impulse current wave form and are defined in international, European and national standards as the test current for components and devices for protection against direct lightning strikes (Figure 4).

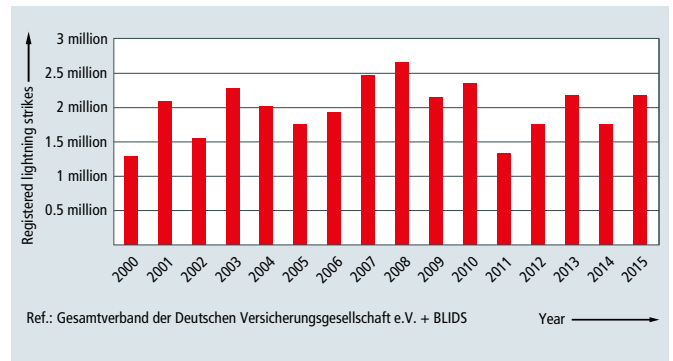

Figure 1: Lightning activity registered in Germany from 2000 to 2015.

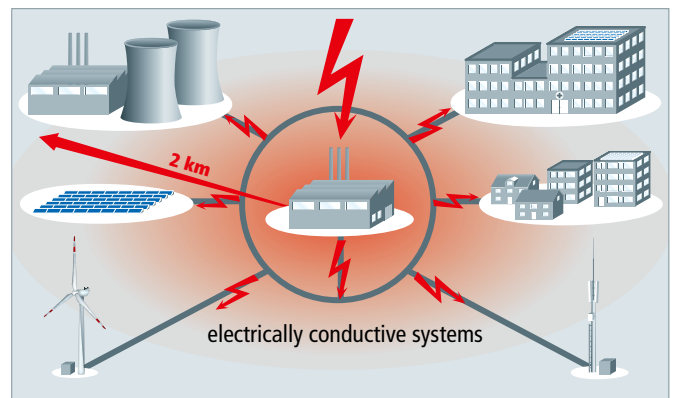

Figure 2: General risks for buildings and installations resulting from lightning strikes.

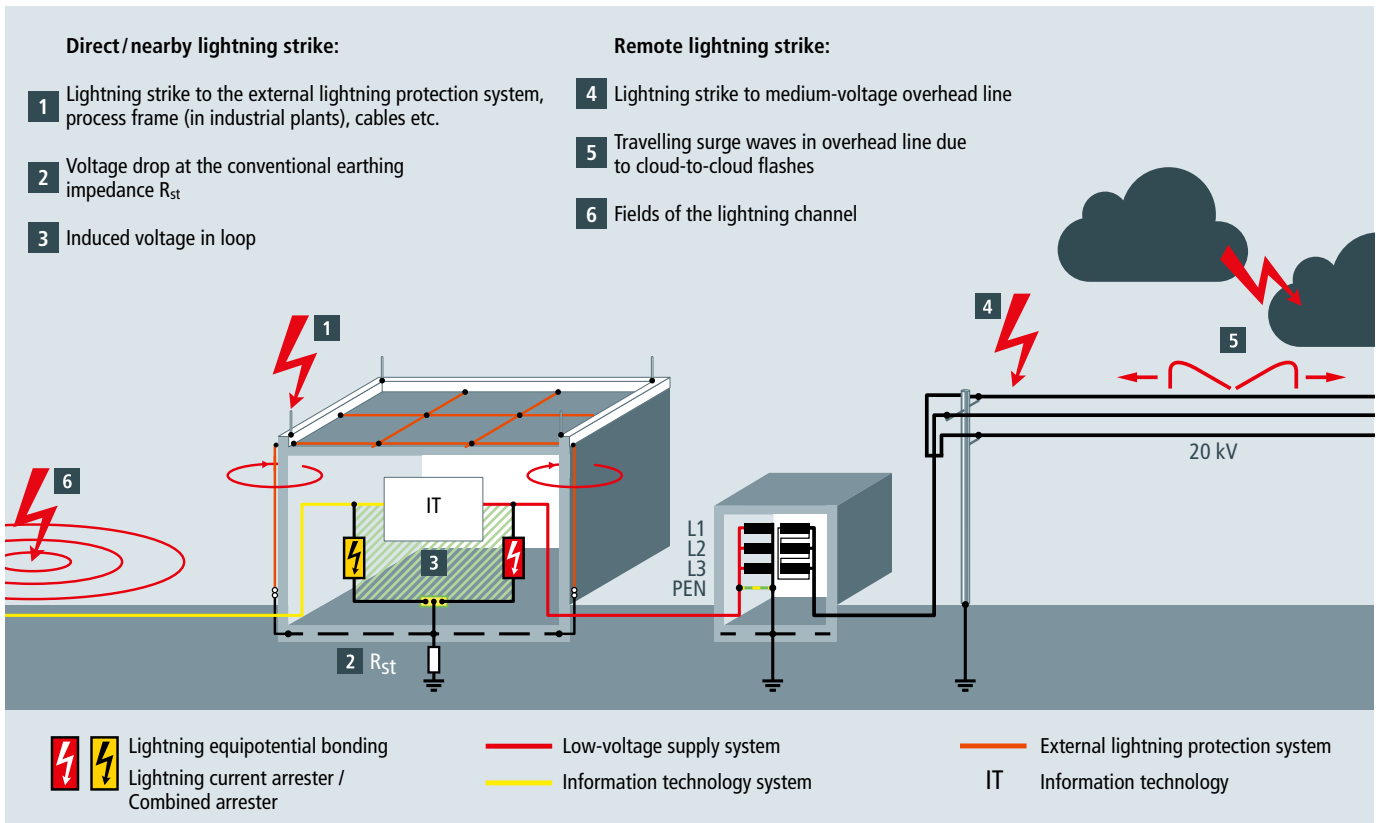

Figure 3: Causes of surges during lightning discharges.

In addition to the voltage drop at the conventional earthing impedance, surges are generated in the electrical installation of a building and the systems and devices connected to it due to the inductive effect of the electromagnetic lightning field (Figure 3, case 3). The energy of these induced surges and of the resulting impulse currents is far lower than the energy of a direct lightning impulse current and is therefore described by a 8/20 μ s impulse current wave form (Figure 4). Components and devices that do not have to conduct currents resulting from direct lightning strikes are therefore tested with such 8/20 μ s impulse currents.

Protection scheme

Lightning strikes are described as remote if they occur a long distance from the object to be protected, strike medium-voltage overhead lines or their surroundings or occur as cloud-to-cloud lightning discharges (Figure 3, cases 4, 5, 6). Similar to induced surges, the effects of remote lightning strikes on the electrical installation of a building are handled by devices and components which have been dimensioned according to 8/20 μ s impulse current waves. Surges caused by switching operations (SEMP) are, for example, generated by:

- Disconnection of inductive loads (e.g. transformers, reactors, motors)
- Arc ignition and interruption (e.g. arc welding equipment)
- Tripping of fuses

The effects of switching operations in the electrical installation of a building can also be simulated by impulse currents of 8/20 μ s wave form under test conditions. To ensure continuous availability of complex power supply and information technology systems even in case of direct lightning interference, further surge protection measures for electrical and electronic installations and devices based on a lightning protection system

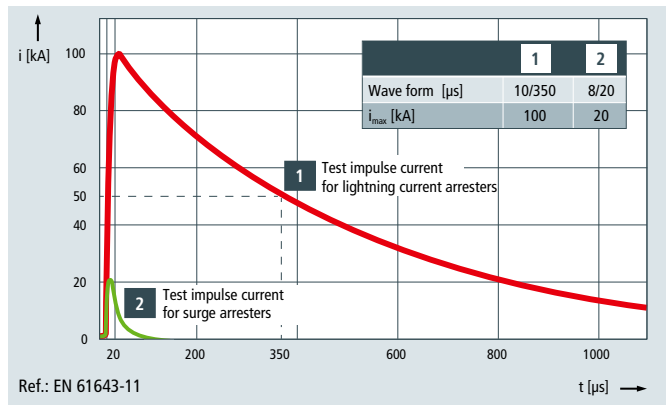

Figure 4: Test impulse currents for lightning current and surge arresters.

for the building are required. It is important to take all causes of surges into account. To do so, the lightning protection zone concept as described in IEC 62305-4 is applied (Figure 5).

Lightning protection zone concept

The building is divided into different endangered zones. These zones help to define the necessary protection measures, in particular the lightning and surge protection devices and components. An EMC-based (EMC = electromagnetic compatibility) lightning protection zone concept includes external lightning protection (air-termination system, down-conductor system, earth-termination system), equipotential bonding, spatial shielding and surge protection for the power supply and information technology systems. Definitions apply as classified in Table 1.

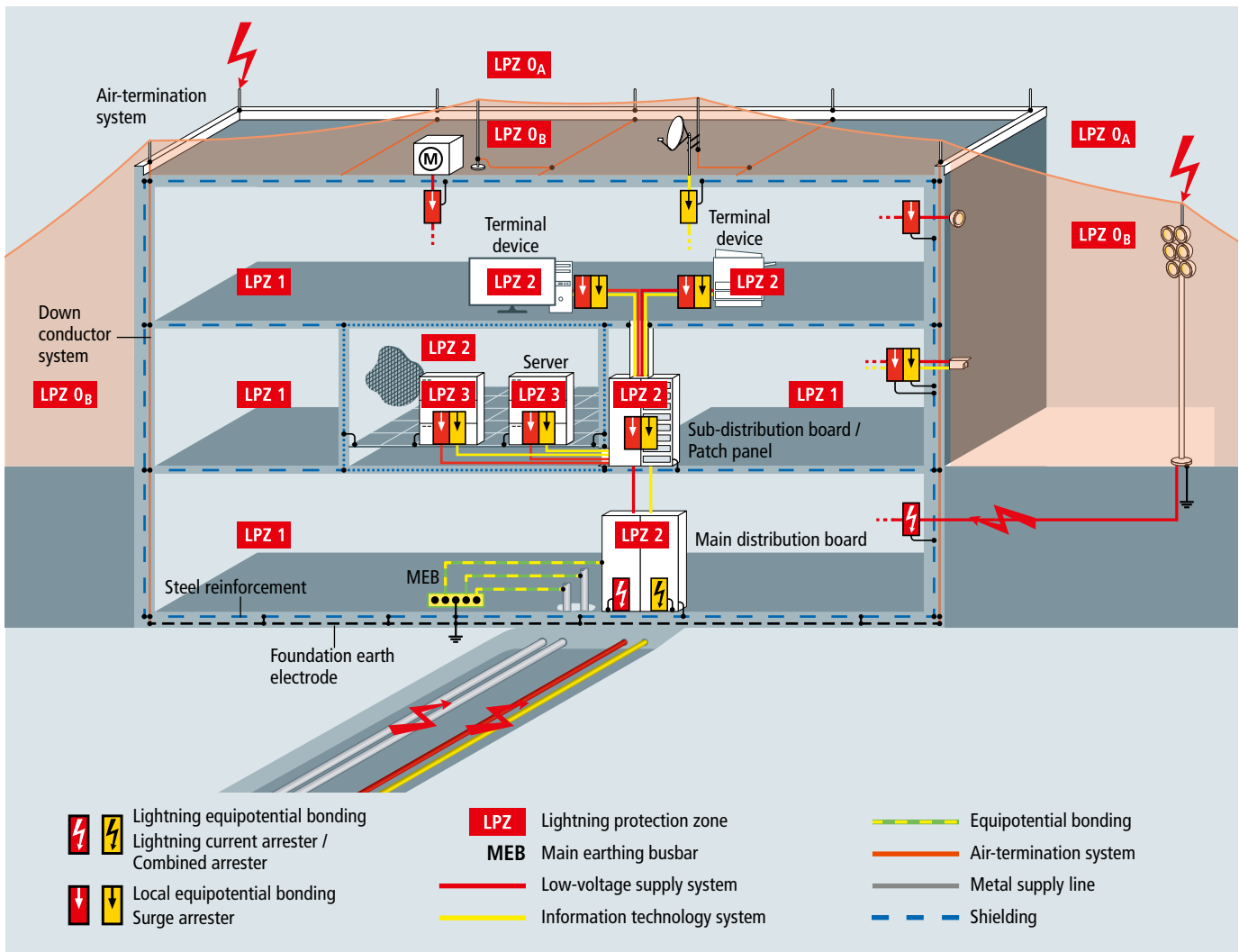
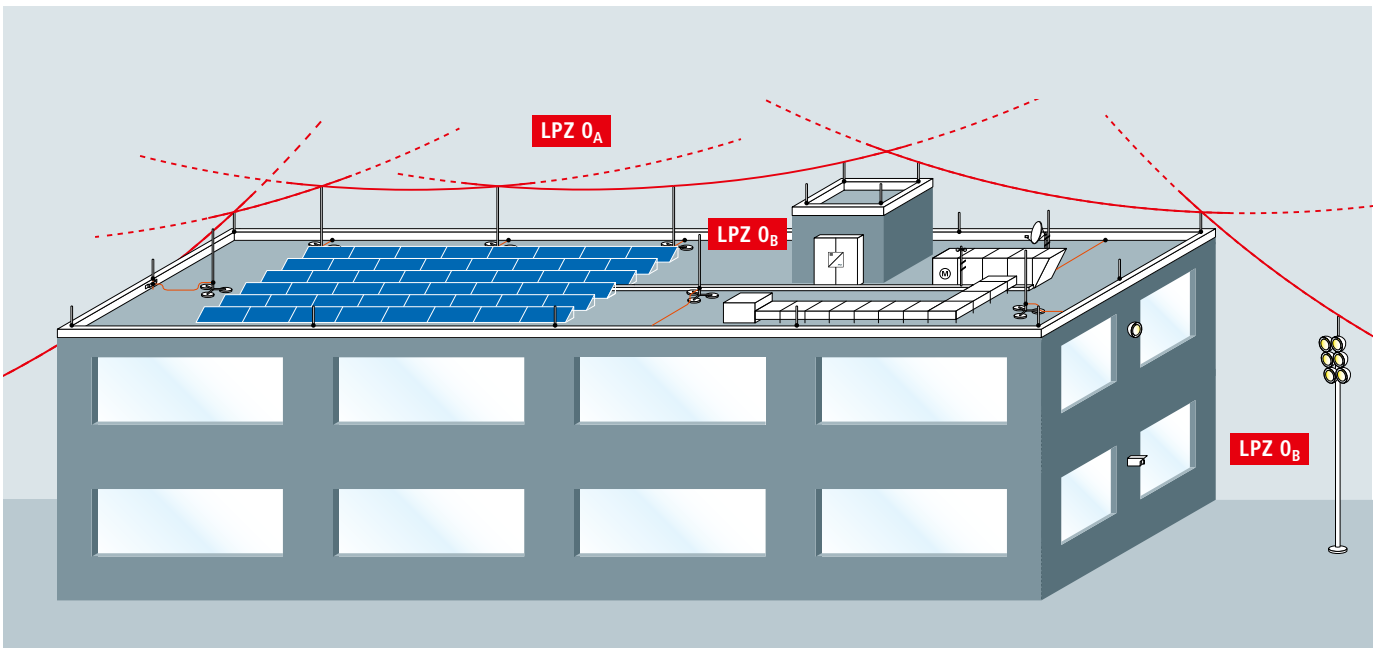
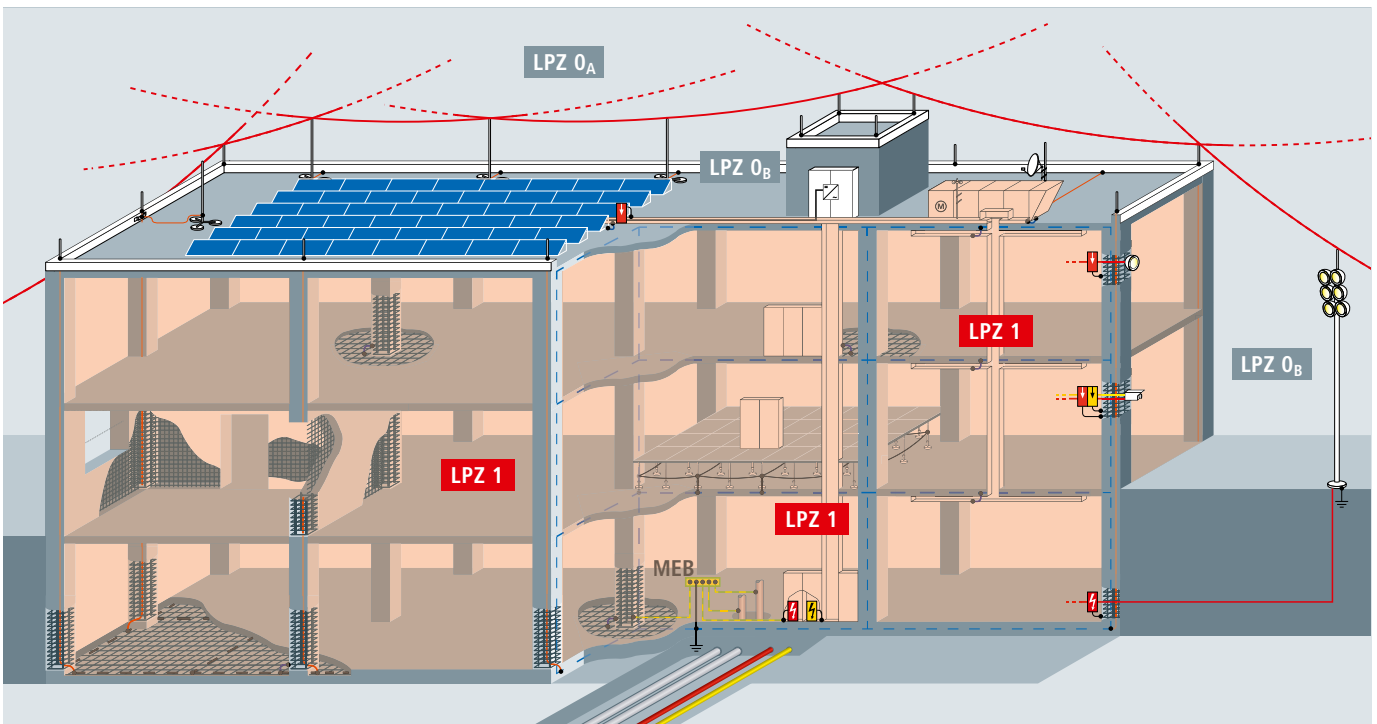

Figure 5: Overall view of a lightning protection zone concept.



▲ Figure 5.1: Transition from LPZ 0_A to LPZ 0_B (above)

▼ Figure 5.2: Transitions from LPZ 0_A to LPZ 1 and LPZ 0_B to LPZ 1 (below)



According to the requirements and loads placed on surge protective devices, they are categorised as lightning current arresters, surge arresters and combined arresters. The highest requirements are placed on the discharge capacity of lightning current arresters and combined arresters used at the transition from lightning protection zone 0_A to 1 or 0_A to 2. These arresters must be capable of conducting partial lightning currents of 10/350 μ s wave form without being destroyed in order to prevent the ingress of destructive partial lightning currents into the electrical installation of a building. At the transition point from LPZ 0_B to 1 or downstream of the lightning current arrester at the transition point from LPZ 1 to 2 and higher, surge arresters are used to protect against surges. Their task is both to reduce the residual energy of the upstream protection stages

even further and to limit the surges induced or generated in the installation itself.

The lightning and surge protective measures at the boundaries of the lightning protection zones described above are equally applicable to power supply and information technology systems. All measures described in the EMC-based lightning protection zone concept help to achieve continuous availability of electrical and electronic devices and installations.

For more detailed technical information, DEHN offers a "Lightning Protection Guide" which can be downloaded at www.dehn-international.com/en/downloads.

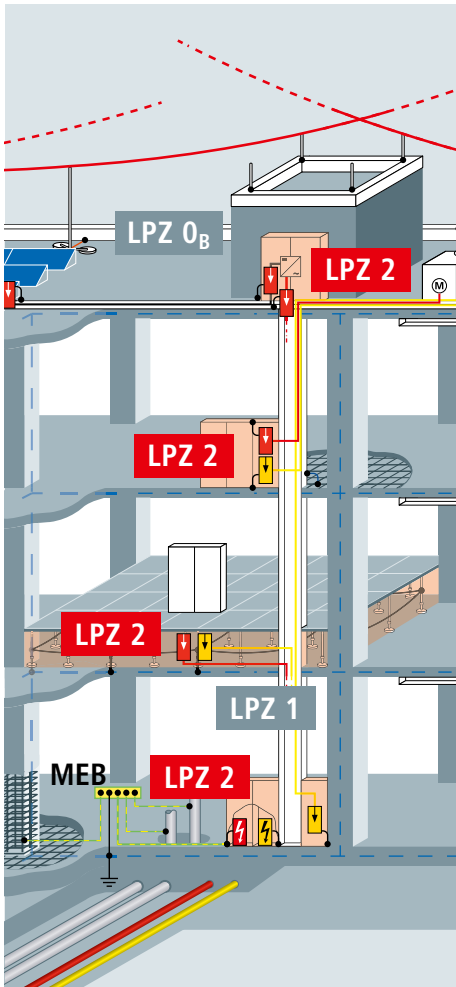

Figure 5.3: Transition from LPZ 1 to LPZ 2

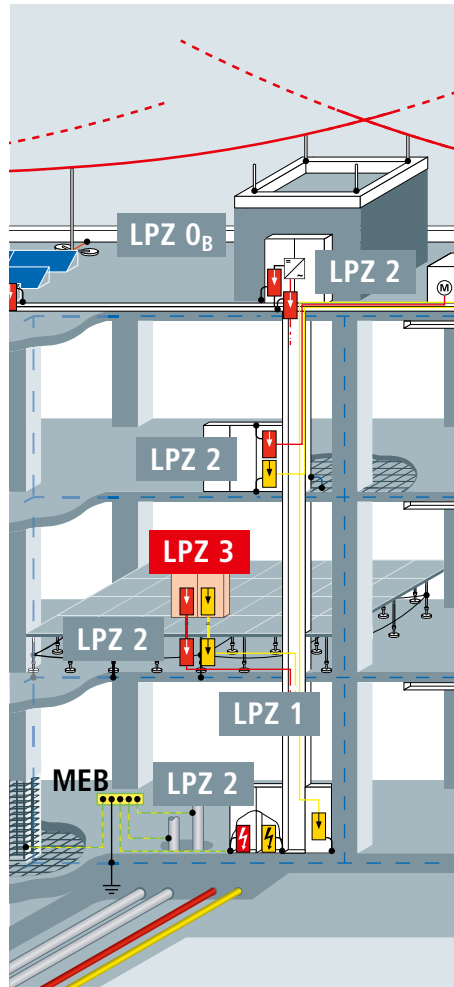
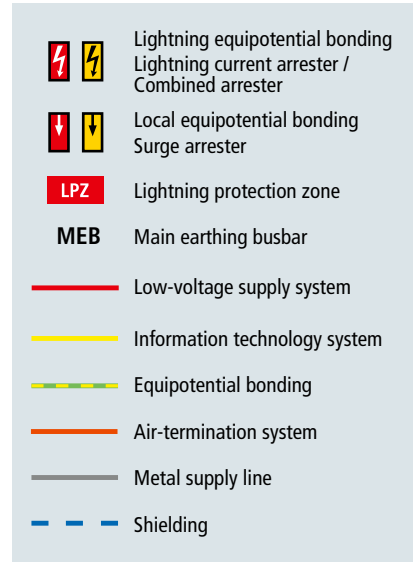

Figure 5.4: Transition from LPZ 2 to LPZ 3



IEC 62305-4:2010

Outer zones:

LPZ 0 Zone where the threat is due to the unattenuated lightning electromagnetic field and where the internal systems may be subjected to full or partial lightning surge current.

LPZ 0 is subdivided into:

LPZ 0_A Zone where the threat is due to the direct lightning flash and the full lightning electromagnetic field. The internal systems may be subjected to full lightning surge current.

LPZ 0_B Zone protected against direct lightning flashes but where the threat is the full lightning electromagnetic field. The internal systems may be subjected to partial lightning surge currents.

Inner zones (protected against direct lightning flashes):

LPZ 1 Zone where the surge current is limited by current sharing and isolating interfaces and/or by SPDs at the boundary. Spatial shielding may attenuate the lightning electromagnetic field.

LPZ 2 ... n Zone where the surge current may be further limited by current sharing and isolating interfaces and/or by additional SPDs at the boundary. Additional spatial shielding may be used to further attenuate the lightning electromagnetic field.

Table 1: Definition of lightning protection zones.

Surge Protective Devices (SPDs)

Surge protective devices are devices consisting mainly of voltage-controlled resistors (varistors, suppressor diodes) and/or spark gaps (discharge paths). Surge protective devices are used to protect other electrical equipment and installations against impermissibly high surges and/or to establish equipotential bonding.

Surge protective devices are classified:

a) according to their **use** into:

- **Surge protective devices for power supply systems and equipment (Red/Line product family)**
for nominal voltage ranges up to 1000 V
– according to EN 61643-11:2012 in type 1/2/3 SPDs
– according to IEC 61643-11:2011 in class I/II/III SPDs
- **Surge protective devices for IT systems and equipment (Yellow/Line product family)**
for protecting modern electronic systems in telecommunications and signal-processing networks with nominal voltages up to 1000 V a.c. [root-mean-square value (rms)] and 1500 V d.c. against the indirect and direct effects of lightning strikes and other transients.
– according to IEC 61643-21:2012, EN 61643-21:2013 and DIN VDE 0845-3-1.
- **Isolating spark gaps for earth-termination systems or equipotential bonding (Red/Line product family)**
- **Surge protective devices for use in photovoltaic installations (Red/Line product family)**
for nominal voltage ranges up to 1500 V
– according to EN 50539-11:2013 as type 1/2 SPDs

b) according to their **impulse current discharge capacity** and protective effect into:

- **Lightning current arresters/Coordinated lightning current arresters**
for interference resulting from direct or nearby lightning strikes for protecting installations and equipment [for use at the boundaries between lightning protection zones (LPZ) O_A and 1].
- **Surge arresters**
for remote lightning strikes, switching overvoltages as well as electrostatic discharges for protecting installations, equipment and terminal devices (for use at the boundaries downstream of LPZ O_B).
- **Combined lightning current and surge arresters**
for interference resulting from direct or nearby lightning strikes for protecting installations, equipment and terminal devices (for use at the boundaries between LPZ O_A and 1 as well as O_A and 2).

Technical data

The technical data of surge protective devices comprise information defining their conditions of use according to:

- use (e.g. installation, power supply conditions, temperature)
- performance in case of interference (e.g. impulse current discharge capacity, follow current extinguishing capability, voltage protection level, response time)
- performance during operation (e.g. nominal current, attenuation, insulation resistance)
- performance in case of failure (e.g. backup fuse, disconnection device, fail-safe, remote signalling option).

actiVsense

The actiVsense technology is integrated in universal combined arresters for protecting information technology installations and devices. The arrester automatically detects the signal voltage applied and optimally adapts the voltage protection level to it. This makes the arrester universally applicable at different interfaces and provides the best possible protection for the devices and system circuits connected to it in case of failure.

Breaking capacity, follow current extinguishing capability I_{fn}

The breaking capacity is the uninfluenced (prospective) r.m.s. value of the mains follow current which can automatically be extinguished by the surge protective device when connecting U_c . It can be verified in an operating duty test according to IEC/EN 61643-11.

Categories according to IEC 61643-21:2012

A number of impulse voltages and impulse currents are described in IEC 61643-21:2012 for testing the current carrying capability and voltage limitation of impulse interference. Table 3 of this standard puts these into categories and provides preferred values. In Table 2 of the IEC 61643-22 standard the sources of transients are assigned to the different impulse categories according to the decoupling mechanism. Category C2 includes inductive coupling (surges), category D1 galvanic coupling (lightning currents). The relevant category is specified in the technical data.

DEHN surge protective devices surpass the values in the specified categories. Therefore, the exact value for the impulse current carrying capability is indicated by the nominal discharge current (8/20 μ s) and the lightning impulse current (10/350 μ s).

Combination wave U_{oc}

A combination wave is generated by a hybrid generator (1.2/50 μ s, 8/20 μ s) with a fictitious impedance of 2 Ω . The open-circuit voltage of this generator is referred to as U_{oc} . U_{oc} is a preferred indicator for type 3 arresters since only these arresters may be tested with a combination wave (according to IEC/EN 61643-11).

Cut-off frequency f_G

The cut-off frequency defines the frequency-dependent behaviour of an arrester. The cut-off frequency is equivalent to the frequency which induces an insertion loss (a_E) of 3 dB under certain test conditions (see EN 61643-21:2013). Unless otherwise indicated, this value refers to a 50 Ω system.

Degree of protection

The IP degree of protection corresponds to the protection categories described in IEC/EN 60529.

Direct Current Disconnection

When using surge arresters in d.c. applications, disconnection must be reliably ensured even if there are no zero crossings. The specifically developed DC Disconnection (DCD) technology acts as a wedge similar to a blocking valve and interrupts the direct current. Consequently, the devices of the DEHNguard SE DC series are capable of safely interrupting direct currents, thus preventing fire damage caused by d.c. switching arcs.

Disconnecting time t_a

The disconnecting time is the time which passes until the power supply is automatically disconnected in case of a failure of the circuit or equipment to be protected. The disconnecting time is an application-specific value resulting from the intensity of the fault current and the characteristics of the protective device.

Energy coordination of SPDs

Energy coordination is the selective and coordinated interaction of cascaded protection elements (= SPDs) of an overall lightning and surge protection concept. This means that the total load of the lightning impulse current is split between the SPDs according to their energy carrying capability. If energy coordination does not work, downstream SPDs are not sufficiently relieved by the upstream SPDs as they intervene too late, insufficiently or not at all. Consequently, downstream SPDs as well as the terminal equipment to be protected may be destroyed.

DIN CLC/TS 61643-12:2010 describes how to verify energy coordination. Spark-gap-based type 1 SPDs offer considerable advantages due to their voltage-switching characteristic (see WAVE BREAKER FUNCTION).

Follow current extinguishing capability I_{fi} :

Prospective short-circuit current that an SPD is able to interrupt independently without disconnection (source: IEC 61643-11).

Frequency range

The frequency range represents the transmission range or cut-off frequency of an arrester depending on the described attenuation characteristics.

Insertion loss

With a given frequency, the insertion loss of a surge protective device is defined by the relation of the voltage value at the place of installation before and after installing the surge protective device. Unless otherwise indicated, the value refers to a 50 Ω system.

Integrated backup fuse

According to the product standard for SPDs, overcurrent protective devices/backup fuses must be used. This, however, requires additional space in the distribution board, additional cable lengths, which should be as short as possible according to IEC 60364-5-53, additional installation time (and costs) and dimensioning of the fuse. A fuse integrated in the arrester ideally suited for the impulse currents involved eliminates all these disadvantages. The space gain, lower wiring effort, integrated fuse monitoring and the increased protective effect due to shorter connecting cables are clear advantages of this concept which is integrated in the DEHNvenCI, DEHNbloc Maxi S, DEHNguard ... CI and V(A) NH product families.

LifeCheck

Repeated discharge processes which exceed the specification of the device can overload arresters in information technology systems. In order to ensure high system availability, arresters should therefore be subjected to systematic tests. LifeCheck allows quick and easy testing of arresters (see page 240).

Lightning impulse current I_{imp}

The lightning impulse current is a standardised impulse current curve with a 10/350 μ s wave form. Its parameters (peak value, charge, specific energy) simulate the load caused by natural lightning currents. Lightning current and combined arresters must be capable of discharging such lightning impulse currents several times without being destroyed.

Mains-side overcurrent protection /arrester backup fuse

Overcurrent protective device (e.g. fuse or circuit breaker) located outside of the arrester on the infeed side to interrupt the power-frequency follow current as soon as the breaking capacity of the surge protective device is exceeded. No additional backup fuse is required since the backup fuse is already integrated in the SPD (see relevant section).

Maximum continuous operating voltage U_c

The maximum continuous operating voltage (maximum permissible operating voltage) is the r.m.s. value of the maximum voltage which may be connected to the corresponding terminals of the surge protective device during operation. This is the maximum voltage on the arrester in the defined non-conducting state, which reverts the arrester back to this state after it has tripped and discharged. The value of U_c depends on the nominal voltage of the system to be protected and the installer's specifications (IEC 60364-5-534).

Maximum continuous operating voltage U_{CPV} for a photovoltaic (PV) system

Value of the maximum d.c. voltage that may be permanently applied to the terminals of the SPD. To ensure that U_{CPV} is higher than the maximum open-circuit voltage of the PV system in case of all external influences (e.g. ambient temperature, solar radiation intensity), U_{CPV} must be higher than this maximum open-circuit voltage by a factor of 1.2 (according to CLC/TS 50539-12). This factor of 1.2 ensures that the SPDs are not incorrectly dimensioned.

Maximum discharge current I_{max}

The maximum discharge current is the maximum peak value of the 8/20 μ s impulse current which the device can safely discharge.

Maximum transmission capacity

The maximum transmission capacity defines the maximum high-frequency power which can be transmitted via a coaxial surge protective device without interfering with the protection component.

Nominal discharge current I_n

The nominal discharge current is the peak value of a 8/20 μ s impulse current for which the surge protective device is rated in a certain test programme and which the surge protective device can discharge several times.

Nominal load current (nominal current) I_L

The nominal load current is the maximum permissible operating current which may permanently flow through the corresponding terminals.

Nominal voltage U_N

The nominal voltage stands for the nominal voltage of the system to be protected. The value of the nominal voltage often serves as type designation for surge protective devices for information technology systems. It is indicated as an r.m.s. value for a.c. systems.

N-PE arrester

Surge protective devices exclusively designed for installation between the N and PE conductor.

Operating temperature range T_U

The operating temperature range indicates the range in which the devices can be used. For non-self-heating devices, it is equal to the ambient temperature range. The temperature rise for self-heating devices must not exceed the maximum value indicated.

Permanent short-circuit current I_k

The r.m.s. value of the short-circuit current in low-voltage or high-voltage three-phase systems which remains after all compensation processes [based on IEC 60909-0].

Protective circuit

Protective circuits are multi-stage, cascaded protective devices. The individual protection stages may consist of spark gaps, varistors, semiconductor elements and gas discharge tubes (see energy coordination).

Protective conductor current I_{PE}

The protective conductor current is the current which flows through the PE connection when the surge protective device is connected to the maximum continuous operating voltage U_c , according to the installation instructions and without load-side consumers.

Remote signalling contact

A remote signalling contact allows easy remote monitoring and indication of the operating state of the device. It features a three-pole terminal in the form of a floating changeover contact. This contact can be used as a break and/or make contact and can thus be easily integrated in the building control system, controller of the switchgear cabinet, etc.

Response time t_A

Response times mainly characterise the response performance of individual protection elements used in arresters. Depending on the rate of rise du/dt of the impulse voltage or di/dt of the impulse current, the response times may vary within certain limits.

Return loss

In high-frequency applications, the return loss refers to how many parts of the "leading" wave are reflected at the protective device (surge point). This is a direct measure of how well a protective device is attuned to the characteristic impedance of the system.

SCI technology

Direct currents (d.c.) flow on the generator side of a PV system. The surge protective devices used on the generator side can be overloaded due to different scenarios (e.g. impulse load, insulation faults) and must not endanger the PV system. However, insufficient d.c. disconnection capability in a PV system may cause fire. Conventional surge arresters only feature a disconnecter in the form of a simple break contact mechanism which is typically used for a.c. devices. Due to the lacking zero crossing of the d.c. source, a d.c. arc may persist and cause fire. The SCI technology patented by DEHN with active arc extinction is an ideal solution. In case of overload, a contact is opened and a short-circuit is generated (short circuit). Thus, any switching arc which may arise is actively, quickly and safely extinguished. The PV fuse integrated in the short-circuit path immediately trips after the arc has been extinguished and ensures safe electrical isolation (interruption) (see also pages 32/84-92). Thus, all PV arresters from DEHN combine surge protection, fire protection and personal protection in a single device.

Series resistance

Resistance in the direction of the signal flow between the input and output of an arrester. The series resistance is normally used to coordinate the protection stages in a multi-stage SPD.

Shield attenuation

Relationship between the power fed into a coaxial cable and the power radiated from the cable through the phase conductor.

Short-circuit withstand capability

The short-circuit withstand capability is the value of the prospective power-frequency short-circuit current handled by the surge protective device when the relevant maximum backup fuse is connected upstream.

Short-circuit current rating I_{SCCR} :

Maximum prospective short-circuit current for which the SPD alone or in conjunction with its disconnectors is rated (source: IEC 61643-11).

Short-circuit rating I_{SCPV} of an SPD in a photovoltaic (PV) system

Maximum uninfluenced short-circuit current which the SPD, alone or in conjunction with its disconnection devices, is able to withstand.

Temporary overvoltage (TOV)

Temporary overvoltage may be present at the surge protective device for a short period of time due to a fault in the high-voltage system. This must be clearly distinguished from a transient caused by a lightning strike or a switching operation, which last no longer than about 1 ms. The amplitude U_T and the duration of this temporary overvoltage are specified in EN 61643-11 (200 ms, 5 s or 120 min.) and are individually tested for the relevant SPDs according to the system configuration (TN, TT, etc.). The SPD can either a) reliably fail (TOV safety) or b) be TOV-resistant (TOV withstand), meaning that it is completely operational during and following temporary overvoltages.

Thermal disconnecter

Surge protective devices for use in power supply systems equipped with voltage-controlled resistors (varistors) mostly feature an integrated thermal disconnecter that disconnects the surge protective device in case of overload and indicates this operating state. The disconnecter responds to the "current heat" generated by an overloaded varistor and disconnects the surge protective device if a certain temperature is exceeded. The disconnecter is designed to disconnect the overloaded surge protective device in time to prevent a fire. It is not intended to ensure protection against indirect contact. The function of these thermal disconnectors can be tested by means of a simulated overload/ageing of the arresters.

Total discharge current I_{total}

Current which flows through the PE, PEN or earth connection of a multipole SPD during the total discharge current test. This test is used to determine the total load if current simultaneously flows through several protective paths of a multipole SPD. This parameter is decisive for the total discharge capacity which is reliably handled by the sum of the individual paths of an SPD.

Voltage protection level U_p

The voltage protection level of a surge protective device is the maximum instantaneous value of the voltage at the terminals of a surge protective device, determined from the standardised individual tests:

- Lightning impulse sparkover voltage 1.2/50 μ s (100%)
- Sparkover voltage with a rate of rise of 1 kV/ μ s
- Measured limit voltage at a nominal discharge current I_n

The voltage protection level characterises the capability of a surge protective device to limit surges to a residual level. The voltage protection level defines the installation location with regard to the overvoltage category according to IEC 60664-1 in power supply systems. For surge protective devices to be used in information technology systems, the voltage protection level must be adapted to the immunity level of the equipment to be protected (IEC 61000-4-5: 2015).

Wave breaker function



Due to the technical design of type 1 SPDs, energy coordination of SPDs varies considerably. Experience has shown that even small amplitudes of the 10/350 μ s lightning impulse current can overload and even destroy downstream SPDs if varistor-based type 1 lightning current arresters are used. In case of spark-gap-based type 1 arresters, in contrast, virtually all the current flows through the type 1 arrester. Similar to a wave breaker the energy is reduced to an acceptable level. The advantage is that the time to half value of the 10/350 μ s impulse current is reduced due to the reduction of the impulse time and the switching behaviour of type 1 SPDs. This considerably relieves downstream SPDs.





All devices of the DEHN Red/Line and Yellow/Line product families are energy-coordinated. Moreover, all type 1 arresters of the Red/Line family are based on spark gaps and thus feature this WAVE BREAKER FUNCTION.







Yellow/Line SPD class

All DEHN arresters for use in information technology systems are categorised into a Yellow/Line SPD class and are marked with the corresponding symbol in the data sheet and on the rating plate (see page 133).

Definition of Symbols

Symbol	Definition
	Installation instructions, see www.dehn-international.com
	New products
	Discontinued products

Symbol	Definition	Red Line
	ACI technology A further development of CI technology, ACI technology consists of a switch/spark gap combination connected in series with a heavy-duty varistor. This ensures the simple design and safe operation of the surge protective device. Other features are safe dimensioning, TOV withstand, a connection cross-section of only 6 mm ² Cu and zero leakage current. Surge arresters with ACI technology offer maximum safety and system availability.	
	Integrated backup fuse Reduced space requirements, lower installation costs, faster wiring and shorter connecting cable lengths are clear advantages of this concept used for the DEHNvenCI, DEHNbloc Maxi S, DEHNguard ... CI and V(A) NH product series.	
	SCI technology The patented SCI technology with active arc extinction allows to actively, quickly and safely extinguish a possible switching arc in case of overload. The PV fuse integrated in the short-circuit path trips immediately after the arc has been extinguished, thus ensuring safe electrical isolation (interruption). Consequently, all PV arresters from DEHN combine surge protection, fire protection and personal protection in a single device.	
	Wave breaker function If a spark-gap-based type 1 arrester is used, the total current flows through the type 1 arrester during the discharge process. Similar to a wave breaker, the energy is mitigated to a sufficiently low level, thus considerably relieving downstream SPDs. The WAVE BREAKER function is integrated in all spark-gap-based type 1 arresters of the Red/Line series.	
	Direct Current Disconnection When using surge arresters in d.c. applications, disconnection must be reliably ensured even if there are no zero crossings. The specifically developed DC Disconnection (DCD) technology acts as a wedge similar to a blocking valve and interrupts the direct current. Consequently, the devices of the DEHNguard SE DC series are capable of safely interrupting direct currents, thus preventing fire damage caused by d.c. switching arcs.	

Symbol	Definition	Yellow Line
	Compact 3-in-1 protection This arrester allows 3 interfaces to be protected by means of a single device, resulting in reduced space requirements, faster wiring and lower installation costs.	
	IP66 Surge arrester for Ethernet / PoE++ applications in an IP66 enclosure for safe use in harsh environments (water and dust).	
	LifeCheck Monitoring of the protection components for thermal load as well as the integrated status indication for protection modules for use in information technology systems allows easy testing and maintenance.	
	RFID LifeCheck RFID LifeCheck makes it possible to easily and quickly test arresters for information technology systems. It permanently monitors the condition of the arrester and detects electrical and thermal load on all protection components.	
TYPE 1	Discharge capacity of an SPD (according to the categories from IEC 61643-21) Impulse D1 (10/350), lightning impulse current 0.5 to 2.5 kA/line	
TYPE 2	• exceeds the discharge capacity of TYPE 2 – TYPE 4	
TYPE 3	Impulse C2 (8/20), increased impulse load 1 to 5 kA/line • exceeds the discharge capacity of TYPE 3 – TYPE 4	
TYPE 4	Impulse C1 (8/20), impulse load 0.25 to 1 kA/line • exceeds the discharge capacity of TYPE 4 Load < TYPE 3	
P1	Protective effect of an SPD (limitation below the test levels according to EN 61000-4-5) Required test level of the terminal device: 1 or higher	
P2	Required test level of the terminal device: 2 or higher	
P3	Required test level of the terminal device: 3 or higher	
P4	Required test level of the terminal device: 4	
	Energy coordination (with another Yellow/Line SPD) SPD with decoupling impedance, suitable for coordination with an SPD marked with  SPD is suitable for coordination with an SPD with decoupling impedance 	

DEHNselect SPD Tool – Planning of internal Lightning Protection and Surge Protection

Practice-oriented – Professional – User-friendly

Find the right product quickly and easily with the help of our surge protection assistants for power supply and information technology systems.



The new DEHNselect SPD software module allows you to define and select all necessary internal lightning protection and surge protection products. It creates a structure plan including a bill of materials and allows fast online access to all documents for the products selected such as data sheets and installation instructions.

DEHNselect SPD is easy to use and requires no special knowledge or training. The user-friendly surface facilitates operating the program.

This electronic planning and selection aid provides easy and practice-oriented support for, e.g. designers, electricians and installers of lightning protection systems, thus making it considerably easier to professionally implement a surge protection concept.

For more detailed information, see brochure DS 709 E (DEHNsupport Tool-box) or visit www.dehn-international.com/en/selection-guides-and-configurators.

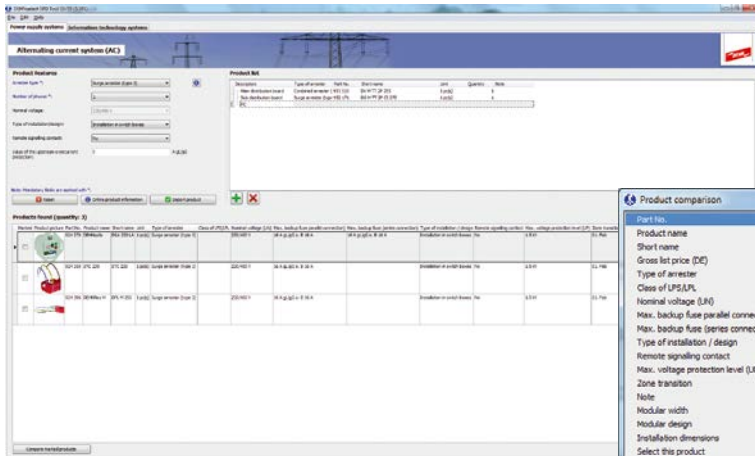

Filter function allows easy product selection

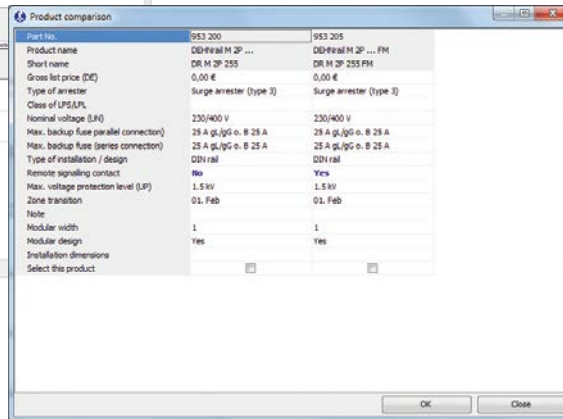

Product comparison

3.4 Bills of material

Power supply systems

Description	Part No.	Short name	Unit	Quantity
Main distribution board	951 205	DVCI 1 255 FM	1 pc.	3
	951 185	DGPM 1 255 FM	1 pc.	1
Sub distribution board General	952 327	DG M TT CI 275 FM	1 pc.	1
Sub distribution board Basement 1	952 327	DG M TT CI 275 FM	1 pc.	1
Extensor luminaire	941 119	DSH TT 2P 255	1 pc.	1
Air conditioner roof	952 315	DG M TT 275 FM	1 pc.	1
Sub distribution board Ground-floor	952 327	DG M TT CI 275 FM	1 pc.	1
Extensor aerator	800 430	DCOR L 2P 275	1 pc.	1
Sub distribution board First Floor	952 327	DG M TT CI 275 FM	1 pc.	1
PC 1 - 8	905 230	DPRO 230	1 pc.	8
PC 9 - 16	905 230	DPRO 230	1 pc.	8

Bill of materials

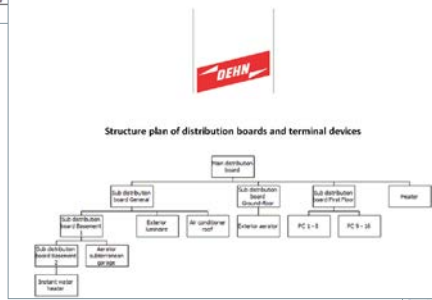

Structure plan

Product Data Sheet: DEHNventil® modular

DV M TNS 255 FM (951 405)

- Preselected spark-gap based type 1 and type 2 combined lightning current and surge arrester consisting of a base part and plug-in protection modules.
- Maximum system availability due to RACAX Flow follow current limitation.
- Capable of protecting terminal equipment.

Modular combined lightning current and surge arrester for TN-S systems.

Part No.	Short name	Unit	Quantity
951 405	DV M TNS 255 FM	1 pc.	1

Product Data Sheet: BLITZDUCTOR® XT – Protection Modules with LifeCheck®

BXT ML4 B 180 (920 310)

- LifeCheck SPD monitoring function
- Four-point lightning protection bonding
- For installation in conformity with the lightning protection zone concept of the boundaries from Zn-1 and higher

Space-saving four-point lightning current arrester module with LifeCheck feature for almost all types of applications. For use in connection with (downstream) surge arresters or combined lightning current and surge arresters with a lower or equal voltage level. LifeCheck detects thermal or electrical overload; the arrester has to be replaced. The status is indicated continuously by the DEHNSupport L2 / S2M / F2C2 master.

Parameter	Value
SPD Class	II (B)
Maximum voltage (U _m)	180 V
Max. continuous operating voltage (U _c) (UL)	180 V
Rated current (I _n) (UL)	127 V
DI Time lightning impulse current (I _{imp}) (UL)	10 kA
DI Lightning impulse current (I _{imp}) (UL)	2.5 kA
CI Time nominal discharge current (I _{cn}) (UL)	20 kA
CI Nominal discharge current (I _{cn}) (UL)	10 kA
Voltage protection level line-to-line (U _p) (UL)	1.600 V
Voltage protection level line-to-ground (U _p) (UL)	1.000 V
Voltage protection level line-to-line at 1000 Hz (U _p) (UL)	1.600 V
Voltage protection level line-to-ground at 1000 Hz (U _p) (UL)	1.000 V
Series resistance per line	0.4 ohm
Capacitance line-to-line (UL)	1 nF
Capacitance line-to-ground (UL)	4 nF
Degree of protection (plug-in protection module)	IP 20

Product data sheet

Product data sheet

Surges – an underestimated risk

Surges are an often underestimated risk. These voltage pulses (transients) that only take a split second are caused by direct, nearby and remote lightning strikes or switching operations of a power utility.

Direct and nearby lightning strikes

Direct or nearby lightning strikes are lightning strikes into a building, in close proximity to it or in lines entering the building (e.g. low-voltage power supply system, telecommunication and data lines). The amplitude and energy content of the resulting impulse currents and impulse voltages as well as the associated electromagnetic field (LEMP) constitute a significant threat to the system to be protected.

The lightning current resulting from a direct lightning strike into a building causes a rise in potential of several 100,000 volts on all earthed devices. Surges are caused by the voltage drop at the conventional earthing impedance and the resulting potential rise of the building with respect to the environment. This is the highest stress on electrical systems in buildings.

In addition to the voltage drop at the conventional earthing impedance, surges occur in the electrical installation of the building and in the connected systems and devices due to the induction effect of the lightning electromagnetic field. The energy of these induced surges and the resulting impulse currents is lower than that of the direct lightning impulse current.

Remote lightning strikes

Remote lightning strikes are lightning strikes far away from the object to be protected, in the medium-voltage overhead line network or in close proximity to it as well as cloud-to-cloud discharge.

Switching operations

Switching operations of power utilities cause surges (SEMP – Switching Electromagnetic Pulse) of some 1,000 volts in electrical systems. They occur, for example, when inductive loads (e.g. transformers, reactors, motors) are switched off, arcs are ignited or fuses trip. If power supply and data lines are installed in parallel, sensitive systems may be interfered with or destroyed.

Protection of power supply and data systems

Destructive transients in residential, office and administration buildings and industrial plants are likely to occur in, for example, the power supply system, information technology system and telephone system, control systems of production facilities via the fieldbus and controllers of air-conditioning or lighting systems. These sensitive systems can only be protected by a comprehensive protection concept. In this context, the coordinated use of surge protective devices (lightning current and surge arresters) is paramount.

The function of lightning current arresters is to discharge high energies without destruction. They are installed as close as possible to the point where the electrical system enters the building. Surge arresters, in turn, protect terminal equipment. They are installed as close as possible to the equipment to be protected.

With its Red/Line for power supply systems and its Yellow/Line for data systems, DEHN offers harmonised surge protective devices. The modular portfolio allows cost-optimised implementation of protection concepts for all building types and installation sizes.

DEHN protects industrial buildings

Keeping production rolling

Lightning and surge protection as well as personal and plant protection ensure that plants and production processes are permanently available. Sensitive technology and automation systems of Industry 4.0 require protection. Machines, plants or sensors communicate with one another and permanently exchange information. This requires a consistent flow of both power and information.

These systems must run reliably even in case of thunderstorms and surges since a production outage entails high costs and can have existential consequences.

DEHN protects functional buildings

Keeping work processes up and running

Whether modern work stations, office buildings or commercial premises – they all require reliable technical components to fulfil their function. Outages must be prevented.

Smart buildings and thus modern work environments depend on sensitive networked technology: Building automation, KNX systems, LED lights and sensitive security, data or communication technology, to name but a few.

Lightning effects and surges put people at risk and lead to downtime and damage to buildings as well as expensive sensitive technology. This results in high replacement and repair costs and loss of productivity, e.g., if entire departments are paralysed and not able to carry out their work.

DEHN protects single-family houses

Providing safety for your home

Modern lifestyle is increasingly defined by digital devices: Smart TV, intelligent home automation, burglary protection systems or electromobility to name but a few. A lot of us already take smart technology for granted. The downside of this technology is that devices are becoming increasingly sensitive and more susceptible to interference.

The more digital devices we use, the more important it is to protect them. This ensures that smart building technology and home offices are permanently available, the heating system works reliably and the WLAN router stays connected to the Internet.

On the following pages you will find **protection solutions for industrial buildings, functional buildings and single-family houses.**

More info:

de.hn/buildings

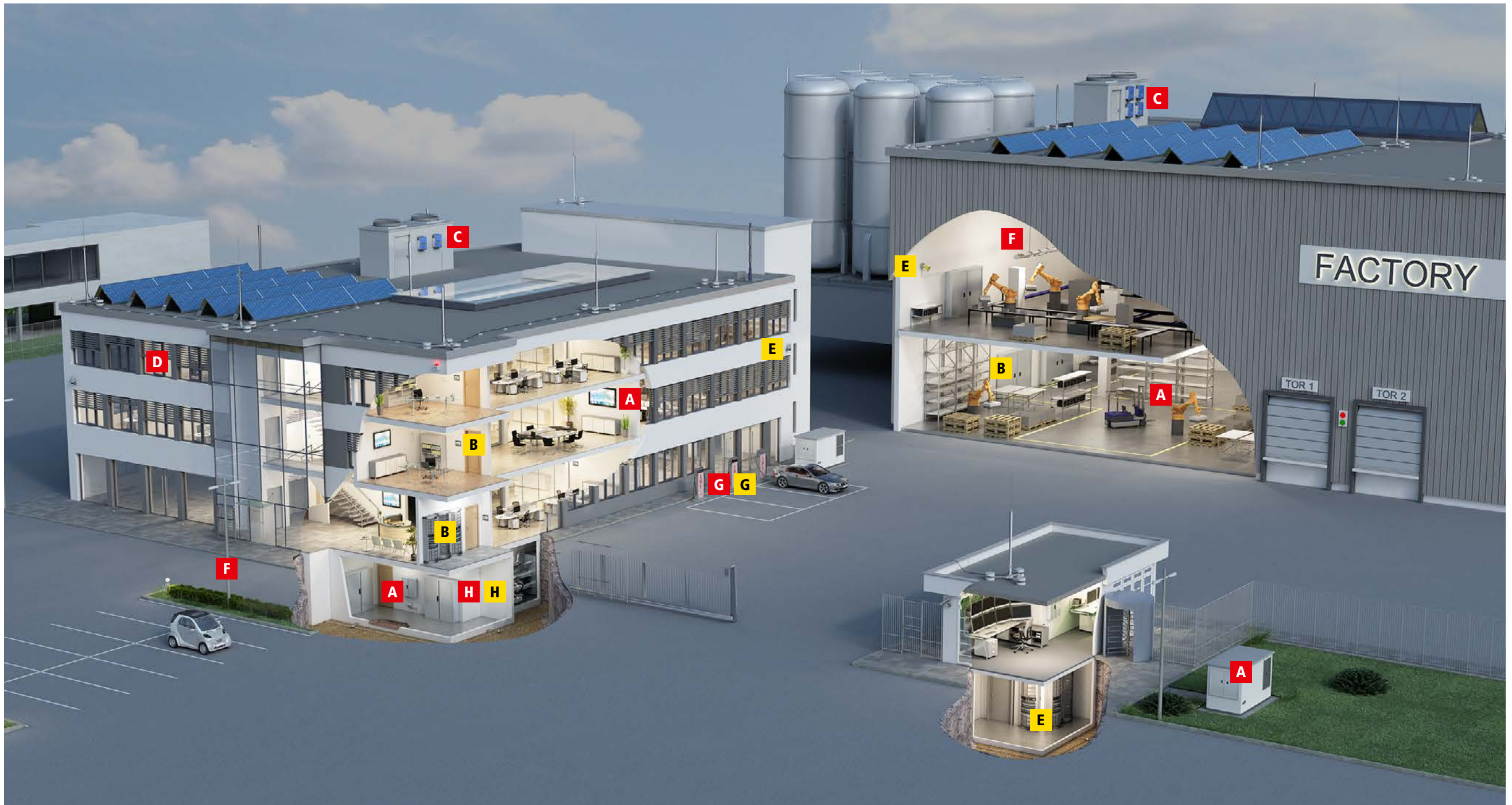

On the following pages you will find detailed selection tables for arresters for industrial buildings:

Surge Protection for Power Supply Systems	Red / Line	Page
Type 1 + type 2 combined arresters / type 1 lightning current arresters		20
Type 2 surge arresters		50
Type 3 surge arresters		103
Surge Protection for Information Technology Systems	Yellow / Line	Page
Selection guide according to interface / signal		135

Application	Type	Part No.	Page
A Power supply			
Transformer substation	DEHNvenCI 255 FM	961 205	26
Low-voltage main distribution board	DEHNventil M TNS 255 FM	951 405	23
Sub-distribution board	DEHNguard M TNS ACI 275 FM	952 440	53
Protection of terminal devices	DEHNflex M 255	924 396	113
	DEHNrail M 4P 255 FM	953 405	106
B Data and telecommunication technology			
LSA technology	DEHNrapid LSA 10 B 180 FSD	907 401	197
KNX/EIB systems	BUSector BT 24	925 001	218
Ethernet cabling	DEHNpatch M CAT6 RJ45S 48	929 100	212
C Photovoltaic system			
Inverter if the separation distance is kept if the separation distance is <i>not</i> kept	DEHNcube YPV SCI 1000 1M	900 910	91
	DEHNcombo YPV 1000 FM	900 075	32
D Electric shutters			
Electric Venetian blinds	DEHNcord R 3P	900 449	80

Application	Type	Part No.	Page
E E Security technology			
Public address system	DEHNvario 2 BY S 150 FM	928 430	190
CCTV camera	DEHNpatch CLE IP66	929 221	211
Safety lighting	DEHNsecure M 1 242	971 122	43
Fire alarm system	Power supply	DEHNrail M 2P 255 FM	953 205
	Data technology	BLITZDUCTORconnect ML2 BE 24	927 224
F LED lights			
Indoor lighting – Light strips	DEHNcord L 3P 275 SO IP	900 447	80
Outdoor lighting	Fuse box EK480 G2S-2d LM DCOR	900 443	79
G G E-mobility			
Charging post	Power supply	DEHNshield TNS FM	941 405
	Information technology	BLITZDUCTORconnect ML2 BD HF 5	927 271
H H Heating / air-conditioning / ventilation			
Heating	Power supply	DEHNrail M 4P 255 FM	953 405
	Information technology	BLITZDUCTORconnect ML2 BE 24	927 224

Product Recommendations – Functional Buildings



Application	Type	Part No.	Page
A Power supply			
Main distribution board	DEHNventil M TNS FM	951 405	23
Sub-distribution board	DEHNguard M TNS ACI 275 FM	952 440	53
Protection of terminal devices	DEHNflex M 255	924 396	113
B Data and telecommunication technology			
LSA technology	DEHNrapid DRL 10 B FSD	907 401	197
KNX/EIB systems	BUSector BT 24	925 001	218
Ethernet cabling	DEHNpatch Class E	929 121	212
C Photovoltaic system			
Inverter			
if the separation distance is kept	DEHNcube YPV SCI 1000 1M	900 910	91
if the separation distance is <i>not</i> kept	DEHNcombo YPV 1000 FM	900 075	32
D Electric shutters			
Electric Venetian blinds	DEHNcord R 3P	900 449	80
E E Security technology			
CCTV camera	DEHNpatch CLE IP66	929 221	211
Safety lighting	DEHNguard SE DC 242	972 120	83
Fire alarm system			
Power supply	DEHNrail M 2P 255 FM	953 205	105
Data technology	BLITZDUCTORconnect ML2 BE 24	927 224	157
F LED lights			
Indoor lighting – Light strips	DEHNcord L 3P 275 SO IP	900 447	80
Outdoor lighting	Fuse box EK480 G2S-2d LM DCOR	900 443	79
G G E-mobility			
Charging post			
Power supply	DEHNshield TNS 255 FM	941 405	29
Information technology	BLITZDUCTORconnect ML2 BD HF 5	927 271	158
H H Heating / air-conditioning / ventilation			
Heating			
Power supply	DEHNrail M 4P 255 FM	953 405	106
Information technology	BLITZDUCTORconnect ML2 BE 24	927 224	157

Product Recommendations – Single-family House WITHOUT External Lightning Protection

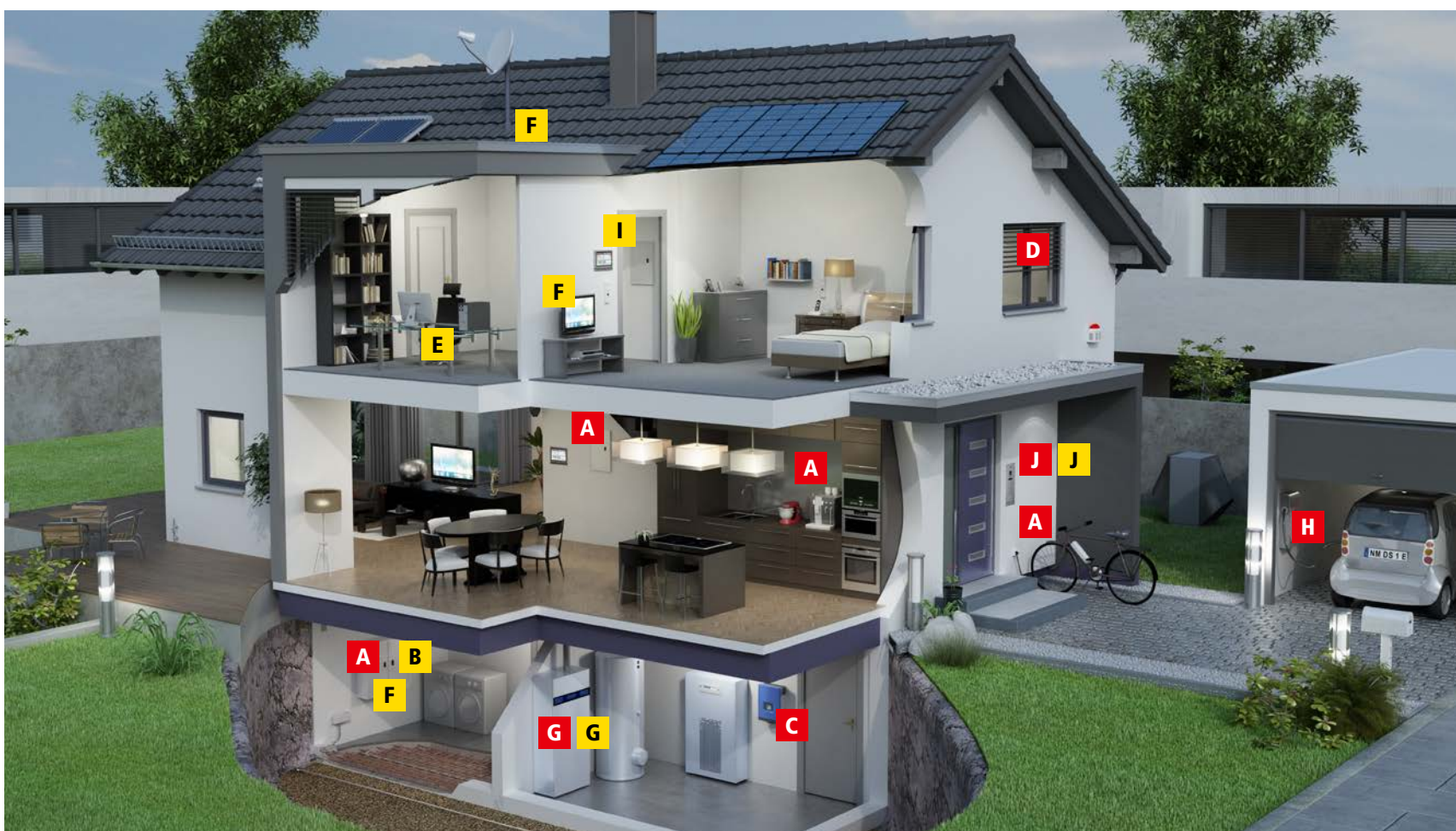

Application	Type	Part No.	Page
A Power supply			
For DIN rails up to 160 A	DEHNshield TNS Basic FM	941 406	29
Sub-distribution board	DEHNguard M	952 400	61
Protection of terminal equipment	DEHNflex M 255	924 396	113
B Data and telecommunication technology			
Telephone / Internet connection	DEHNbox TC B 180	922 220	220
C Photovoltaic system			
Inverter			
for 1 MPP input	DEHNcube YPV SCI 1000 1M	900 910	91
for 2 MPP inputs	DEHNcube YPV SCI 1000 2M	900 920	91
D Electric sun protection and blinds			
Electric shutters	DEHNcord R 3P 275	900 449	80
E Home office			
Computer work station	DEHNprotector LAN100	909 321	217
F TV connection			
TV/SAT system	DEHNgate FF5 TV	909 706	223
Broadband connection	DEHNgate FF TV	909 703	223
TVs	DEHNprotector 230 TV	909 300	216
G G Heat pump			
Power supply	DEHNrail M 4P 255	953 400	106
Data supply	BLITZDUCTORconnect CL2 BE24	927 924	183
H E-mobility			
Wall box	DEHNcord 3P TT 275 FM	900 439	78
I Smart Home			
KNX/EIB system	BUSector BT 24	925 001	218
J J Safety technology			
LED lights	DEHNcord L 2P SN1860	999 937	79
Intercom	BUSector BT 24	925 001	218

Surge Protection for POWER SUPPLY SYSTEMS

SPDs for low-voltage installations and devices



Red / Line

International Power Supply Systems

International system configurations* according to IEC 60364-1

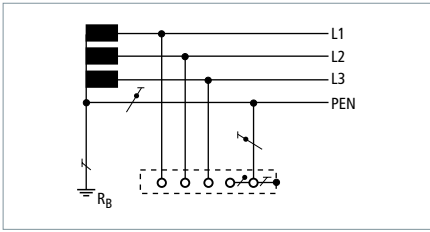

TN-C system 230 / 400 V

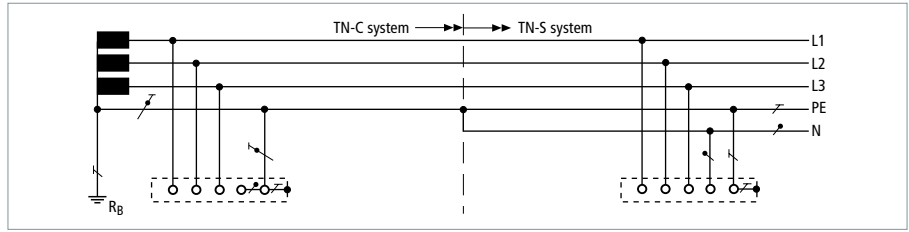

TN-C-S system 230 / 400 V

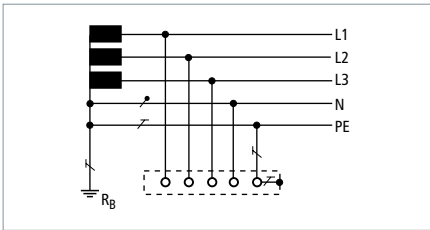

TN-S system 230 / 400 V

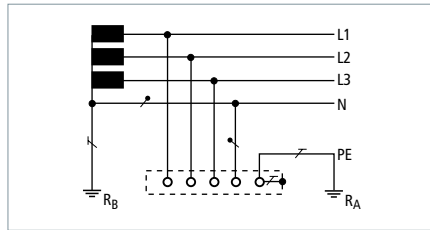

TT system 230 / 400 V

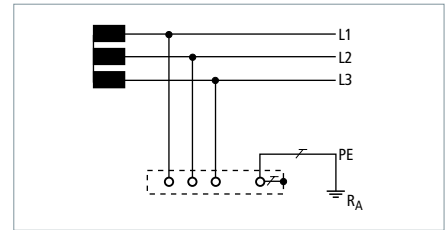

IT system 230 V

Further international system configurations*

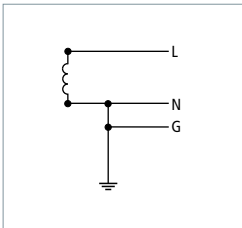

single-phase; 3 wire

(1 Ph, 2 W + G)
110 V
120 V
220 V
240 V

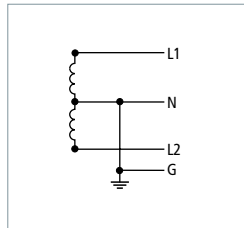

**single-phase; 4 wire
Split Phase or Edison**

(1 Ph, 3 W + G)
120 V / 240 V

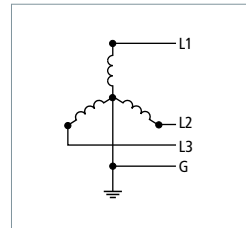

three-phase; 4 wire

(3 Ph Y, 3 W + G)
480 V

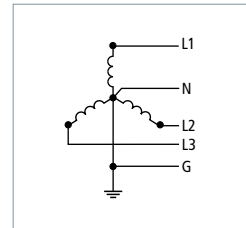

three-phase; 5 wire

(3 Ph Y, 4 W + G)
120 V / 208 V
277 V / 480 V

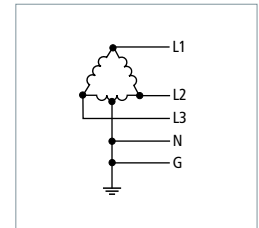

**three-phase; 5 wire
Delta "Highleg"**

(3 Ph Δ, 4 W + G)
120 V / 240 V

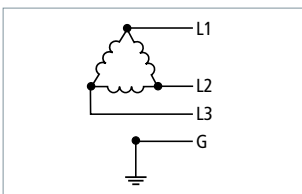

**three-phase; 4 wire
Delta "Ungrounded"**

(3 Ph Δ, 3 W + G)
240 V
480 V

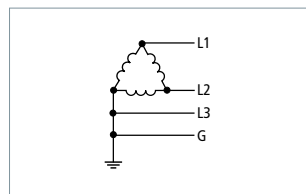

**three-phase; 4 wire
Delta "Grounded Corner"**

(3 Ph Δ, 3 W + G)
240 V
480 V

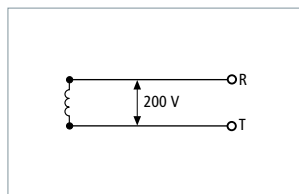

single-phase; 2 wire

(1 Ph, 2 W)
200 V

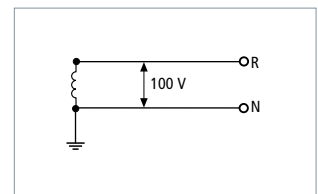

single-phase; 2 wire

(1 Ph, 2 W)
100 V

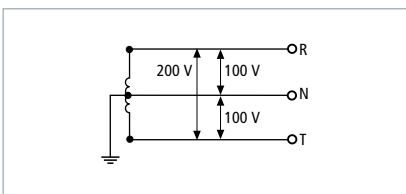

single-phase; 3 wire

(1 Ph, 3 W)
100 V / 200 V

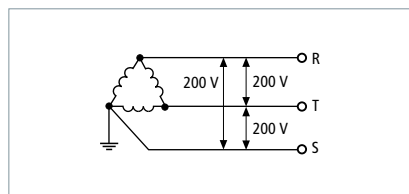

three-phase; 3 wire

(3 Ph, 3 W)
200 V

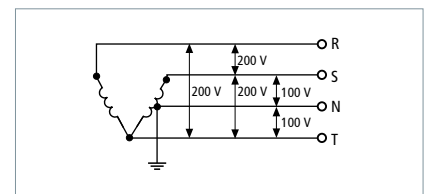

three-phase + single-phase

100 V / 200 V; 200 V

* System according to the earth connection (according to IEC 60364-1)



Combined Arresters – Type 1 + Type 2

20



Lightning Current Arresters – Type 1

33



N-PE Lightning Current Arresters

47

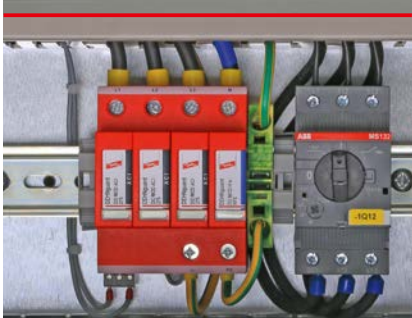

Surge Arresters – Type 2

50



Surge Arresters – Type 3

103



Measuring Devices and Accessories

117

Selection Chart – Industrial Buildings

TN-C system	TN-S system	TT system	230/400 V a.c.	400/690 V a.c.	Higher voltages (a.c.)	Integrated backup fuse	Type 1 + type 2 combined arresters	Type 1 lightning current arresters	DIN rail	Busbar	d.c. applications	PV system	Remote signalling contact (FM)	Type	Part No.	Page
3 pcs	4 pcs	3 pcs	●		●	●		●						DVCI 1 255	961 200	26
		N-PE	●			●		●						DGPM 1 255	961 180	48
3 pcs	4 pcs	3 pcs	●		●	●		●				●		DVCI 1 255 FM	961 205	26
		N-PE	●			●		●				●		DGPM 1 255 FM	961 185	48
1 pc			●			●		●						DV M TNC 255	951 300	23
1 pc			●			●		●				●		DV M TNC 255 FM	951 305	23
	1 pc		●			●		●						DV M TNS 255	951 400	23
	1 pc		●			●		●				●		DV M TNS 255 FM	951 405	23
		1 pc	●			●		●						DV M TT 255	951 310	23
		1 pc	●			●		●				●		DV M TT 255 FM	951 315	23
3 pcs	4 pcs	3 pcs	●					●	●					DB M 1 255	961 120	34
		N-PE	●					●	●					DGP M 255	961 101	48
3 pcs	4 pcs	3 pcs	●					●	●			●		DB M 1 255 FM	961 125	34
		N-PE	●					●	●			●		DGP M 255 FM	961 105	48
3 pcs	4 pcs	3 pcs	●		●		●		●		910 631			DBM 1 255 S	900 220	41
		N-PE	●				●		●		910 631			DGPM 1 255 S	900 050	48
3 pcs	4 pcs	3 pcs		●	●		●	●				●		DBM 1 CI 440 FM	961 146	38
3 pcs	4 pcs	3 pcs		●			●	●				●		DBM 1 440 FM	961 145	40
		N-PE		●			●	●				●		DGPM 440 FM	961 165	48
3 pcs	4 pcs	3 pcs		●			●	●						DBM 1 440	961 140	40
		N-PE		●			●	●						DGPM 440	961 160	48
3 pcs	4 pcs			●	●		●	●				●		DBM 1 CI 760 FM	961 176	38
3 pcs	4 pcs			●			●	●				●		DBM 1 760 FM	961 175	40
							●	●		●				DSE M 1 242	971 122	43
							●	●		●				DSE M 1 242 FM	971 127	44
						●		●			●			DCB YPV 1200	900 070	32
						●		●			●	●		DCB YPV 1200 FM	900 075	32

* Energy coordination with terminal equipment (≤ 10 m)

Selection Chart – Functional Buildings

TN-C system	TN-S system	TT system	Integrated backup fuse	Type 1 + type 2 (+ type 3)*	Type 1 lightning current arresters	DIN rail	Busbar	d.c. applications	Remote signalling contact (FM)	Type	Part No.	Page
3 pcs	4 pcs	3 pcs	●	●		●				DVCI 1 255	961 200	26
		1 pc		●		●				DGPM 1 255	961 180	48
3 pcs	4 pcs	3 pcs	●	●		●			●	DVCI 1 255 FM	961 205	26
		1 pc		●		●			●	DGPM 1 255 FM	961 185	48
1 pc				●		●				DV M TNC 255	951 300	23
1 pc				●		●			●	DV M TNC 255 FM	951 305	23
	1 pc			●		●				DV M TNS 255	951 400	23
	1 pc			●		●			●	DV M TNS 255 FM	951 405	23
		1 pc		●		●				DV M TT 255	951 310	23
		1 pc		●		●			●	DV M TT 255 FM	951 315	23
3 pcs	4 pcs	3 pcs			●	●				DB M 1 255	961 120	34
		1 pc			●	●				DGP M 255	961 101	48
3 pcs	4 pcs	3 pcs			●	●			●	DB M 1 255 FM	961 125	34
		1 pc			●	●			●	DGP M 255 FM	961 105	48
3 pcs	4 pcs	3 pcs	●		●		●		910 631	DBM 1 255 S	900 220	41
		1 pc	●		●		●		910 631	DGPM 1 255 S	900 050	48
				●		●		●		DSE M 1 242	971 122	43
				●		●		●	●	DSE M 1 242 FM	971 127	44

Combined Arresters – Type 1 + Type 2

Selection Chart – Single-Family House

TN-C system	TN-S system	TT system	Type 1 + type 2 (+ type 3)*	Type 1 lightning current arresters	External LPS installed	DIN rail	PV system	Remote signalling contact (FM)	Type	Part No.	Page
1 pc			●		●	●			DSH TNC 255	941 300	28
1 pc			●		●	●		●	DSH TNC 255 FM	941 305	28
1 pc			●			●		●	DSH B TNC 255 FM	941 306	28
	1 pc		●		●	●			DSH TNS 255	941 400	28
	1 pc		●		●	●		●	DSH TNS 255 FM	941 405	28
	1 pc		●			●		●	DSH B TNS 255 FM	941 406	29
		1 pc	●		●	●			DSH TT 255	941 310	29
		1 pc	●		●	●		●	DSH TT 255 FM	941 315	29
		1 pc	●			●		●	DSH B TT 255 FM	941 316	30
3 pcs	4 pcs	3 pcs		●	●	●			DB M 1 255	961 120	34
		N-PE		●	●	●			DGP M 255	961 101	48
3 pcs	4 pcs	3 pcs		●	●	●		●	DB M 1 255 FM	961 125	34
		N-PE		●	●	●		●	DGP M 255 FM	961 105	48
							●		DCB YPV 1200	900 070	32
							●	●	DCB YPV 1200 FM	900 075	32

* Energy coordination with terminal equipment (≤ 10 m)

DEHNventil modular

For protecting low-voltage consumer's installations against surges and even direct lightning strikes. For installation in conformity with the lightning protection zone concept at the boundaries from $0_A - 2$.

- Prewired spark-gap-based type 1 and type 2 combined lightning current and surge arrester consisting of a base part and plug-in protection modules
- Maximum system availability due to RADAX Flow follow current limitation
- No tripping of 20 A gG fuses up to short-circuit currents of $50 \text{ kA}_{\text{rms}}$
- Discharge capacity up to 100 kA (10/350 μs)
- Capable of protecting terminal equipment
- Operating state / fault indication by green / red indicator flag in the inspection window
- Easy replacement of protection modules without tools due to module locking system with module release button
- Vibration and shock-tested according to EN 60068-2

DEHNventil M TNC 255: Modular combined lightning current and surge arrester for use in TN-C systems

DEHNventil M TNS 255: Modular combined lightning current and surge arrester for use in TN-S systems

DEHNventil M TT 255: Modular combined lightning current and surge arrester for use in TT and TN-S systems (3+1 configuration)

DEHNventil M TN 255: Modular combined lightning current and surge arrester for use in single-phase TN systems

DEHNventil M TT 2P 255: Modular combined lightning current and surge arrester for use in single-phase TT and TN systems (1+1 configuration)

DEHNventil M ... FM: With remote signalling contact for monitoring device (floating changeover contact)

With their functional Red/Line design, the devices of the modular DEHNventil family provide a combination of safety and innovation. Designed for "all-in-one installation", the arresters integrate lightning equipotential bonding and surge protection in a single device, making them ideal for use in compact electrical installations. The energy-coordinated arresters even allow you to protect terminal equipment if the distance between DEHNventil and the consumers is $\leq 10 \text{ m}$. With a lightning current discharge capacity up to 100,000 A, the arresters ensure a high degree of availability of the electrical installation to be protected. Even in large-scale electrical installations, the modular DEHNventil arresters provide various application benefits. The Red/Line surge arresters installed at the boundaries of the individual lightning protection zones, for example, are already energy-coordinated with the DEHNventil arresters.

Encapsulated creepage discharge spark gaps and the small space requirements enable easy integration into switchgear installations or distribution boards. A special feature of the modular DEHNventil family is its functional design, in particular the module locking system. It fixes the protection module firmly in place so that it is safely connected to the base part even with maximum loads. If a protection module has to be replaced, it can be easily released and removed without tools by pressing the release button. By using the double terminals suitable for all conductors, the arresters can be connected in series in a space-saving and cost-effective way up to nominal currents of 125 A as preferred by IEC 60364-5-53. Busbars of type MVS 3 8 6 and MVS 4 11 8 can be used for connecting further DIN rail mounted devices. Selection of the DEHNventil devices is very straightforward based on the network form of the existing low-voltage consumer installation in conjunction with the device type designation.

The patented RADAX Flow technology for follow current limitation and extinction allows high availability of the electrical consumer installation to be protected. Even in case of short-circuit currents as high as $100 \text{ kA}_{\text{rms}}$, mains follow currents are reduced in such a way that selectivity with respect to low-current-rated fuses is ensured. This means that upstream fuses will not trip due to upcoming mains follow currents.

The operating state / fault indicator of each protective path does not cause operating currents and instantly shows the operating state of the surge arrester. Apart from the standard visual indicator with green and red indicator flags, DEHNventil M ... FM devices feature a three-pole remote signalling terminal. As the remote signalling contact is designed as a floating changeover contact, the remote signal can, depending on the circuit concept, be used as a make or break contact.

Due to their parameters and design, the devices can even be installed upstream of meter panels in low-voltage consumer installations.

Due to their parameters and design, the devices can even be installed upstream of meter panels in low-voltage consumer installations.

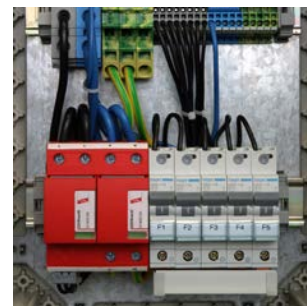

DEHNventil M TNC (FM)

Modular combined lightning current and surge arrester for TN-C systems with a nominal voltage of 230/400 V (3+0 configuration); FM version with floating remote signalling contact.

Type DV M ...	TNC 255	TNC 255 FM
Part No.	951 300	951 305
SPD according to EN 61643-11 / IEC 61643-11	type 1 + type 2 / class I + class II	type 1 + type 2 / class I + class II
Max. continuous operating voltage (a.c.) (U_c)	264 V (50 / 60 Hz)	264 V (50 / 60 Hz)
Lightning impulse current (10/350 μ s) [L1+L2+L3-PEN] (I_{total})	75 kA	75 kA
Lightning impulse current (10/350 μ s) [L-PEN] (I_{imp})	25 kA	25 kA
Voltage protection level (U_p)	≤ 1.5 kV	≤ 1.5 kV
Max. backup fuse (L) up to $I_K = 50$ kA _{rms}	315 A gG	315 A gG
Approvals	KEMA, VDE, UL	KEMA, VDE, UL
Type of remote signalling contact	—	changeover contact
Extended technical data:	For use in switchgear installations with prospective short-circuit currents of more than 50 kA_{rms} (tested by the German VDE)	
– Max. prospective short-circuit current	100 kA _{rms} (220 kA _{peak})	100 kA _{rms} (220 kA _{peak})



DEHNventil M TNS (FM)

Modular combined lightning current and surge arrester for TN-S systems with a nominal voltage of 230/400 V (4+0 configuration); FM version with floating remote signalling contact.

Type DV M ...	TNS 255	TNS 255 FM
Part No.	951 400	951 405
SPD according to EN 61643-11 / IEC 61643-11	type 1 + type 2 / class I + class II	type 1 + type 2 / class I + class II
Max. continuous operating voltage (a.c.) (U_c)	264 V (50 / 60 Hz)	264 V (50 / 60 Hz)
Lightning impulse current (10/350 μ s) [L1+L2+L3+N-PE] (I_{total})	100 kA	100 kA
Lightning impulse current (10/350 μ s) [L, N-PE] (I_{imp})	25 kA	25 kA
Voltage protection level [L-PE]/[N-PE] (U_p)	$\leq 1.5 / \leq 1.5$ kV	$\leq 1.5 / \leq 1.5$ kV
Max. backup fuse (L) up to $I_K = 50$ kA _{rms}	315 A gG	315 A gG
Approvals	KEMA, VDE, UL	KEMA, VDE, UL
Type of remote signalling contact	—	changeover contact
Extended technical data:	For use in switchgear installations with prospective short-circuit currents of more than 50 kA_{rms} (tested by the German VDE)	
– Max. prospective short-circuit current	100 kA _{rms} (220 kA _{peak})	100 kA _{rms} (220 kA _{peak})



DEHNventil M TT (FM)

Modular combined lightning current and surge arrester for TT and TN-S systems with a nominal voltage of 230/400 V (3+1 configuration); FM version with floating remote signalling contact.

Type DV M ...	TT 255	TT 255 FM
Part No.	951 310	951 315
SPD according to EN 61643-11 / IEC 61643-11	type 1 + type 2 / class I + class II	type 1 + type 2 / class I + class II
Max. continuous operating voltage (a.c.) [L-N] (U_c)	264 V (50 / 60 Hz)	264 V (50 / 60 Hz)
Lightning impulse current (10/350 μ s) [L1+L2+L3+N-PE] (I_{total})	100 kA	100 kA
Lightning impulse current (10/350 μ s) [L-N]/[N-PE] (I_{imp})	25 / 100 kA	25 / 100 kA
Voltage protection level [L-N]/[N-PE] (U_p)	$\leq 1.5 / \leq 1.5$ kV	$\leq 1.5 / \leq 1.5$ kV
Max. backup fuse (L) up to $I_K = 50$ kA _{rms}	315 A gG	315 A gG
Approvals	KEMA, VDE, UL	KEMA, VDE, UL
Type of remote signalling contact	—	changeover contact
Extended technical data:	For use in switchgear installations with prospective short-circuit currents of more than 50 kA_{rms} (tested by the German VDE)	
Voltage protection level [L-PE] (U_p)	2.2 kV	2.2 kV
– Max. prospective short-circuit current	100 kA _{rms} (220 kA _{peak})	100 kA _{rms} (220 kA _{peak})



DEHNventil M TN (FM)

Modular combined lightning current and surge arrester for single-phase TN systems with a nominal voltage of 230 V (2+0 configuration); FM version with floating remote signalling contact.



Type DV M ...	TN 255	TN 255 FM
Part No.	951 200	951 205
SPD according to EN 61643-11 / IEC 61643-11	type 1 + type 2 / class I + class II	type 1 + type 2 / class I + class II
Max. continuous operating voltage (a.c.) (U_c)	264 V (50 / 60 Hz)	264 V (50 / 60 Hz)
Lightning impulse current (10/350 μ s) [L+N-PE] (I_{total})	50 kA	50 kA
Lightning impulse current (10/350 μ s) [L, N-PE] (I_{imp})	25 kA	25 kA
Voltage protection level [L-PE]/[N-PE] (U_p)	$\leq 1.5 / \leq 1.5$ kV	$\leq 1.5 / \leq 1.5$ kV
Max. backup fuse (L) up to $I_k = 50$ kA _{rms}	315 A gG	315 A gG
Approvals	KEMA, VDE, UL	KEMA, VDE, UL
Type of remote signalling contact	—	changeover contact
Extended technical data:	For use in switchgear installations with prospective short-circuit currents of more than 50 kA_{rms} (tested by the German VDE)	
– Max. prospective short-circuit current	100 kA _{rms} (220 kA _{peak})	100 kA _{rms} (220 kA _{peak})

DEHNventil M TT 2P (FM)

Modular combined lightning current and surge arrester for single-phase TT and TN-S systems with a nominal voltage of 230 V (1+1 configuration); FM version with floating remote signalling contact.



Type DV M ...	TT 2P 255	TT 2P 255 FM
Part No.	951 110	951 115
SPD according to EN 61643-11 / IEC 61643-11	type 1 + type 2 / class I + class II	type 1 + type 2 / class I + class II
Max. continuous operating voltage (a.c.) [L-N] (U_c)	264 V (50 / 60 Hz)	264 V (50 / 60 Hz)
Lightning impulse current (10/350 μ s) [L+N-PE] (I_{total})	50 kA	50 kA
Lightning impulse current (10/350 μ s) [L-N]/[N-PE] (I_{imp})	25 / 50 kA	25 / 50 kA
Voltage protection level [L-N]/[N-PE] (U_p)	$\leq 1.5 / \leq 1.5$ kV	$\leq 1.5 / \leq 1.5$ kV
Max. backup fuse (L) up to $I_k = 50$ kA _{rms}	315 A gG	315 A gG
Approvals	KEMA, VDE, UL	KEMA, VDE, UL
Type of remote signalling contact	—	changeover contact
Extended technical data:	For use in switchgear installations with prospective short-circuit currents of more than 50 kA_{rms} (tested by the German VDE)	
Voltage protection level [L-PE] (U_p)	2.2 kV	2.2 kV
– Max. prospective short-circuit current	100 kA _{rms} (220 kA _{peak})	100 kA _{rms} (220 kA _{peak})

Protection Module for DEHNventil modular

- High discharge capacity due to powerful creepage discharge spark gap
- Maximum system availability due to RADAX Flow follow current limitation
- Easy replacement of protection modules without tools due to module locking system with module release button
- Operating state / fault indication by green / red indicator flag in the inspection window
- The plug-in protection module can be replaced without the need to de-energise and without removing the distribution board cover

In multipole protective circuits, we recommend replacing the complete set of protection modules when one module fails.



For protecting low-voltage consumer installations against surges and even direct lightning strikes. For installation in conformity with the lightning protection zone concept at the boundaries from $0_A - 2$.

- DV MOD 255:** Spark-gap-based protection module
- DV MOD NPE 50:** 50 kA N-PE spark-gap-based protection module
- DV MOD NPE 100:** 100 kA N-PE spark-gap-based protection module

The spark-gap-based protection modules of the modular DEHNventil series combine safety and innovation in a single device. Apart from the encapsulated RADAX Flow spark gap technology, the compact protection modules incorporate the complete monitoring circuit for controlling the energy flow of the spark gap, the monitoring device and the operating state / fault indicator.

The mechanical coding of the protection module prevents that the N-PE protection modules are confused with the spark-gap-based module for the phase conductors.

The module locking mechanism fixes the protection modules to the base part. Protection modules can be easily removed without tools by simply pressing the module release button.

Avoid additional, short-notice and unplanned maintenance jobs. In multipole protective circuits, we recommend replacing the complete set of protection modules when one module fails.



Spark-Gap-Based Protection Module

Spark-gap-based protection module for DEHNventil M ...

Type DV MOD ...	255
Part No.	951 001
Max. continuous operating voltage (a.c.) (U_c)	264 V
Lightning impulse current (10/350 μ s) (I_{imp})	25 kA



N-PE Spark-Gap-Based Protection Module

N-PE spark-gap-based protection module for DEHNventil M ... with ... + 1 configuration.

Type DV MOD ...	NPE 50	NPE 100
Part No.	951 050	951 100
Max. continuous operating voltage (a.c.) (U_c)	255 V	255 V
Lightning impulse current (10/350 μ s) (I_{imp})	50 kA	100 kA





DEHNvenCI



For protecting low-voltage consumer installations against surges and even direct lightning strikes. For installation in conformity with the lightning protection zone concept at the boundaries from $0_A - 2$.

Featuring the functional Red/Line family design, coordinated DEHNvenCI combined lightning current and surge arresters provide maximum system protection and take up little space. The features of the practice-proven DEHNventil family were combined with a lightning current carrying arrester backup fuse in an enclosure with a width of only two modules.

Due to the increasingly compact design of switchgear installations, the standard-compliant installation of lightning current arresters is difficult for the user. The DEHNvenCI not only meets requirements regarding the space-saving integration of a combined lightning current and surge arrester, but also satisfies the protection requirements of modern switchgear installations. The integrated arrester backup fuse is dimensioned to ensure maximum discharge capacity and optimal system protection.

The need to select and install an arrester backup fuse is eliminated, ensuring short connecting cable lengths as required in IEC 60364-5-53.

Consequently, DEHNvenCI is an efficient combined arrester which is easy to install.

The energy-coordinated arresters even allow protection of terminal devices or sensitive electronic systems in modern switchgear installations if the distance between DEHNvenCI and the loads is ≤ 10 m.

- Spark-gap based combined lightning current and surge arrester with integrated lightning current carrying backup fuse
- Energy coordination with other arresters of the Red/Line product family
- Low voltage protection level $U_p \leq 1.5$ kV (including backup fuse)
- Maximum system availability due to RADAX Flow follow current limitation
- Extinction of mains follow currents up to 100 kA_{rms}
- High lightning current discharge capacity of 25 kA ($10/350$ μ s)
- Capable of protecting terminal equipment
- Operating state / fault indication by green / red indicator flag in the inspection window

DEHNvenCI 1 255: Single-pole combined lightning current and surge arrester with integrated backup fuse

DEHNvenCI 1 255 FM: With remote signalling contact for monitoring device (floating changeover contact)

The patented RADAX Flow technology for follow current limitation and extinction ensures the high availability of the electrical consumer installation to be protected.

Even in case of short-circuit currents as high as 100 kA_{rms}, DEHNvenCI can be used in industrial systems without restrictions.

The ability to carry lightning impulse currents without destruction and simultaneously reduce the energy to an acceptable level for terminal devices ensures the availability of the switchgear installation in case of a lightning strike. This considerably reduces the risk of cost-intensive failures.

The operating state / fault indicator of DEHNvenCI, which houses the fuse monitoring system and does not cause operating currents, shows the operating state of the arrester. Apart from the standard visual indicator with green and red indicator flags, DEHNvenCI 1 255 FM devices feature a three-pole remote signalling terminal. As the remote signalling contact is designed as a floating changeover contact, the remote signal can, depending on the circuit concept, be used as a make or break contact.

DEHNvenCI 255 (FM)

Single-pole combined lightning current and surge arrester with integrated lightning current carrying backup fuse for use in 230/400 V systems; FM version with floating remote signalling contact.



Type DVCI 1 ...	255	255 FM
Part No.	961 200	961 205
SPD according to EN 61643-11 / IEC 61643-11	type 1 + type 2 / class I + class II	type 1 + type 2 / class I + class II
Maximum continuous operating voltage (a.c.) (U_c)	255 V (50 / 60 Hz)	255 V (50 / 60 Hz)
Lightning impulse current ($10/350$ μ s) (I_{imp})	25 kA	25 kA
Voltage protection level (U_p)	≤ 1.5 kV	≤ 1.5 kV
Max. mains-side overcurrent protection	not required	not required
Approvals	KEMA	KEMA
Type of remote signalling contact	—	changeover contact
Extended technical data:	For use in switchgear installations with prospective short-circuit currents of more than 50 kA_{rms} (tested by the German VDE)	
– Max. prospective short-circuit current	100 kA _{rms} (220 kA _{peak})	100 kA _{rms} (220 kA _{peak})

Accessories for DEHNvenCI

Earthing Clip for two-module Enclosures, single-phase, two-pole / three-pole / four-pole

Earthing clip for connecting the earth terminal of e.g. two/three/four SPDs with two-module enclosure to earth, with terminal.

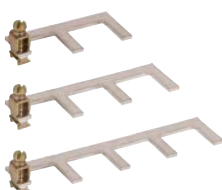

Type	EB 1 2 5	EB DG 1000 1 3	EB 1 4 9
Part No.	900 419	900 411	900 417
Dimensions	$34 \times 77 \times 28$ mm	$34 \times 112 \times 28$ mm	$34 \times 148 \times 28$ mm
Terminal	up to 25 mm ²	up to 25 mm ²	up to 25 mm ²

DEHNshield

- Application-optimised and prewired spark-gap-based type 1 + type 2 combined lightning current and surge arrester
- Compact design due to space-saving spark gap technology with a width of only one module / pole
- Fulfils the minimum requirements on the lightning current discharge capacity according to IEC 60364-5-53
- Allows compact lightning equipotential bonding including protection of terminal equipment
- Discharge capacity up to 50 kA (10/350 μ s)
- Operating state / fault indication by green / red indicator flag in the inspection window
- High follow current extinguishing capacity ($I_{fi} = 25 \text{ kA}_{rms}$)



For protecting compact low-voltage consumer's installations against surges and even direct lightning strikes. For installation in conformity with the lightning protection zone concept at the boundaries from $0_A - 2$.

- DaEHNshield TNC 255:** Application-optimised combined lightning current and surge arrester for TN-C systems
- DEHNshield TNS 255:** Application-optimised combined lightning current and surge arrester for TN-S systems
- DEHNshield TT 255:** Application-optimised combined lightning current and surge arrester for TT and TN-S systems (3+1 configuration)
- DEHNshield TN 255:** Application-optimised combined lightning current and surge arrester for single-phase TN systems
- DEHNshield TT 2P 255:** Application-optimised combined lightning current and surge arrester for single-phase TT and TN systems (1+1 configuration)
- DEHNshield ... FM:** With remote signalling contact for monitoring device (floating changeover contact)

The space-saving and application-optimised DEHNshield family offers various benefits provided by type 1 + type 2 spark-gap-based arresters such as the "wave breaker function" (WBF). This function and the associated reduction of the pulse time mitigate the energy of the lightning impulse current to an acceptable level for downstream protection stages or terminal equipment. Moreover, DEHNshield arresters are directly energy coordinated with other arresters of the Red/Line product family.

Application-optimised DEHNshield combined lightning current and surge arresters combine lightning equipotential bonding up to lightning impulse currents of 50 kA (10/350 μ s) and surge protection in a single device.

This clearly distinguishes DEHNshield from varistor-based arresters of this application and performance class.

Due to their technical parameters and the very compact design as spark-gap-based arresters with only one module / pole, DEHNshield arresters are ideally suited for this application class. For this reason, they are a space-saving and application-optimised solution in particular for residential buildings.

DEHNshield arresters also provide optimal protection in existing buildings without an external lightning protection system where roof superstructures or overhead line supplies are installed which require type 1 SPDs according to Vds 2031.

No additional backup fuse is required if an installation is protected by backup fuses up to 160 A.

The energy-coordinated arresters even protect terminal equipment if the distance between DEHNshield and the consumers is $\leq 10 \text{ m}$. The non-exhausting spark gap and the small space requirements of the application-optimised combined lightning current and surge arresters enable easy integration into distribution boards.

The follow-current-limiting spark gap technology ensures selectivity with regard to low-current-rated fuses (35 A gG). This means that upstream fuses will not trip due to mains follow currents.

Busbars and pin-shaped terminals from DEHN can be used for connecting DEHNshield to other DIN rail mounted devices. The type designation of DEHNshield makes it easy to choose the right arrester for the relevant system configuration of the low-voltage consumer's installation.

The operating state / fault indicator of every protective path does not cause operating currents and instantly shows the operating state of the arrester. Apart from the standard visual indicator with green and red indicator flags, the DEHNshield ... FM versions feature a three-pole remote signalling terminal. As the remote signalling contact is designed as a floating changeover contact, the remote signal can, depending on the circuit concept, be used as a make or break contact.



Series connection by means of a lightning-current-tested STAK 25 pin-shaped terminal

Due to their parameters and design, DEHNshield devices can even be installed upstream of meter panels in low-voltage consumer installations.

DEHNshield TNC

Application-optimised and prewired combined lightning current and surge arrester for TN-C systems with a nominal voltage of 230/400 V (3+0 configuration).



Type DSH ...	TNC 255
Part No.	941 300
SPD according to EN 61643-11 / IEC 61643-11	type 1 + type 2 / class I + class II
Max. continuous operating voltage (a.c.) (U _c)	255 V (50 / 60 Hz)
Lightning impulse current (10/350 μs) [L1+L2+L3-PEN] (I _{total})	37.5 kA
Lightning impulse current (10/350 μs) [L-PEN] (I _{imp})	12.5 kA
Voltage protection level (U _p)	≤ 1.5 kV
Max. mains-side overcurrent protection	160 A gG
Approvals	KEMA, VDE, UL

DEHNshield TNC FM

Application-optimised and prewired combined lightning current and surge arrester for TN-C systems with a nominal voltage of 230/400 V (3+0 configuration); with floating remote signalling contact.



Type DSH ...	TNC 255 FM
Part No.	941 305
SPD according to EN 61643-11 / IEC 61643-11	type 1 + type 2 / class I + class II
Max. continuous operating voltage (a.c.) (U _c)	255 V (50 / 60 Hz)
Lightning impulse current (10/350 μs) [L1+L2+L3-PEN] (I _{total})	37.5 kA
Lightning impulse current (10/350 μs) [L-PEN] (I _{imp})	12.5 kA
Voltage protection level (U _p)	≤ 1.5 kV
Max. mains-side overcurrent protection	160 A gG
Approvals	KEMA, VDE
Type of remote signalling contact	changeover contact

DEHNshield TNC Basic FM

Application-optimised and prewired combined lightning current and surge arrester for TN-C systems for use in the main power supply system (3+0 configuration) in case of residential buildings without external lightning protection system (also in case of buildings supplied by overhead lines); with floating remote signalling contact.



Type DSH ...	B TNC 255 FM
Part No.	941 306
SPD according to EN 61643-11 / IEC 61643-11	type 1 + type 2 / class I + class II
Max. continuous operating voltage (a.c.) (U _c)	255 V (50 / 60 Hz)
Lightning impulse current (10/350 μs) [L1+L2+L3-PEN] (I _{total})	22.5 kA
Lightning impulse current (10/350 μs) [L-PEN] (I _{imp})	7.5 kA
Voltage protection level (U _p)	≤ 1.5 kV
Max. mains-side overcurrent protection	160 A gG
Approvals	VDE
Type of remote signalling contact	changeover contact

DEHNshield TNS

Application-optimised and prewired combined lightning current and surge arrester for TN-S systems with a nominal voltage of 230/400 V (4+0 configuration).



Type DSH ...	TNS 255
Part No.	941 400
SPD according to EN 61643-11 / IEC 61643-11	type 1 + type 2 / class I + class II
Max. continuous operating voltage (a.c.) (U _c)	255 V (50 / 60 Hz)
Lightning impulse current (10/350 μs) [L1+L2+L3+N-PE] (I _{total})	50 kA
Lightning impulse current (10/350 μs) [L, N-PE] (I _{imp})	12.5 kA
Voltage protection level [L-PE]/[N-PE] (U _p)	≤ 1.5 / ≤ 1.5 kV
Max. mains-side overcurrent protection	160 A gG
Approvals	KEMA, VDE, UL

DEHNshield TNS FM

Application-optimised and prewired combined lightning current and surge arrester for TN-S systems with a nominal voltage of 230/400 V (4+0 configuration); with floating remote signalling contact.

Type DSH ...	TNS 255 FM
Part No.	941 405
SPD according to EN 61643-11 / IEC 61643-11	type 1 + type 2 / class I + class II
Max. continuous operating voltage (a.c.) (U_c)	255 V (50 / 60 Hz)
Lightning impulse current (10/350 μ s) [L1+L2+L3+N-PE] (I_{total})	50 kA
Lightning impulse current (10/350 μ s) [L, N-PE] (I_{imp})	12.5 kA
Voltage protection level [L-PE]/[N-PE] (U_p)	$\leq 1.5 / \leq 1.5$ kV
Max. mains-side overcurrent protection	160 A gG
Approvals	KEMA, VDE
Type of remote signalling contact	changeover contact



DEHNshield TNS Basic FM

Application-optimised and prewired combined lightning current and surge arrester for TN-S systems for use in the main power supply system (4+0 configuration) in case of residential buildings without external lightning protection system (also in case of buildings supplied by overhead lines); with floating remote signalling contact.

Type DSH ...	B TNS 255 FM
Part No.	941 406
SPD according to EN 61643-11 / IEC 61643-11	type 1 + type 2 / class I + class II
Max. continuous operating voltage (a.c.) (U_c)	255 V (50 / 60 Hz)
Lightning impulse current (10/350 μ s) [L1+L2+L3+N-PE] (I_{total})	30 kA
Lightning impulse current (10/350 μ s) [L, N-PE] (I_{imp})	7.5 kA
Voltage protection level [L-PE]/[N-PE] (U_p)	$\leq 1.5 / \leq 1.5$ kV
Max. mains-side overcurrent protection	160 A gG
Approvals	VDE
Type of remote signalling contact	changeover contact



DEHNshield TT

Application-optimised and prewired combined lightning current and surge arrester for TT and TN-S systems with a nominal voltage of 230/400 V (3+1 configuration).

Type DSH ...	TT 255
Part No.	941 310
SPD according to EN 61643-11 / IEC 61643-11	type 1 + type 2 / class I + class II
Max. continuous operating voltage (a.c.) (U_c)	255 V (50 / 60 Hz)
Lightning impulse current (10/350 μ s) [L1+L2+L3+N-PE] (I_{total})	50 kA
Lightning impulse current (10/350 μ s) [L-N]/[N-PE] (I_{imp})	12.5 / 50 kA
Voltage protection level [L-N]/[N-PE] (U_p)	$\leq 1.5 / \leq 1.5$ kV
Max. mains-side overcurrent protection	160 A gG
Approvals	KEMA, VDE, UL
Extended technical data:	
Voltage protection level [L-PE] (U_p)	2.0 kV



DEHNshield TT FM

Application-optimised and prewired combined lightning current and surge arrester for TT and TN-S systems with a nominal voltage of 230/400 V (3+1 configuration); with floating signalling contact.

Type DSH ...	TT 255 FM
Part No.	941 315
SPD according to EN 61643-11 / IEC 61643-11	type 1 + type 2 / class I + class II
Max. continuous operating voltage (a.c.) (U_c)	255 V (50 / 60 Hz)
Lightning impulse current (10/350 μ s) [L1+L2+L3+N-PE] (I_{total})	50 kA
Lightning impulse current (10/350 μ s) [L-N]/[N-PE] (I_{imp})	12.5 / 50 kA
Voltage protection level [L-N]/[N-PE] (U_p)	$\leq 1.5 / \leq 1.5$ kV
Max. mains-side overcurrent protection	160 A gG
Approvals	KEMA, VDE
Type of remote signalling contact	changeover contact
Extended technical data:	
Voltage protection level [L-PE] (U_p)	2.0 kV



DEHNshield TT Basic FM

Application-optimised and prewired combined lightning current and surge arrester for TT and TN-S systems for use in the main power supply system (3+1 configuration) in case of residential buildings without external lightning protection system (also in case of buildings supplied by overhead lines); with floating remote signalling contact.



Type DSH ...	B TT 255 FM
Part No.	941 316
SPD according to EN 61643-11 / IEC 61643-11	type 1 + type 2 / class I + class II
Max. continuous operating voltage (a.c.) (U_c)	255 V (50 / 60 Hz)
Lightning impulse current (10/350 μ s) [L1+L2+L3+N-PE] (I_{total})	30 kA
Lightning impulse current (10/350 μ s) [L-N]/[N-PE] (I_{imp})	7.5 / 30 kA
Voltage protection level [L-N]/[N-PE] (U_p)	$\leq 1.5 / \leq 1.5$ kV
Max. mains-side overcurrent protection	160 A gG
Approvals	VDE
Type of remote signalling contact	changeover contact
Extended technical data:	
Voltage protection level [L-PE] (U_p)	2.0 kV

DEHNshield TN

Application-optimised and prewired combined lightning current and surge arrester for single-phase TN systems with a nominal voltage of 230 V (2+0 configuration).



Type DSH ...	TN 255
Part No.	941 200
SPD according to EN 61643-11 / IEC 61643-11	type 1 + type 2 / class I + class II
Max. continuous operating voltage (a.c.) (U_c)	255 V (50 / 60 Hz)
Lightning impulse current (10/350 μ s) [L+N-PE] (I_{total})	25 kA
Lightning impulse current (10/350 μ s) [L, N-PE] (I_{imp})	12.5 kA
Voltage protection level [L-PE]/[N-PE] (U_p)	$\leq 1.5 / \leq 1.5$ kV
Max. mains-side overcurrent protection	160 A gG
Approvals	KEMA, VDE, UL

DEHNshield TN FM

Application-optimised and prewired combined lightning current and surge arrester for single-phase TN systems with a nominal voltage of 230 V (2+0 configuration); with floating remote signalling contact.



Type DSH ...	TN 255 FM
Part No.	941 205
SPD according to EN 61643-11 / IEC 61643-11	type 1 + type 2 / class I + class II
Max. continuous operating voltage (a.c.) (U_c)	255 V (50 / 60 Hz)
Lightning impulse current (10/350 μ s) [L+N-PE] (I_{total})	25 kA
Lightning impulse current (10/350 μ s) [L, N-PE] (I_{imp})	12.5 kA
Voltage protection level [L-PE]/[N-PE] (U_p)	$\leq 1.5 / \leq 1.5$ kV
Max. mains-side overcurrent protection	160 A gG
Approvals	KEMA, VDE
Type of remote signalling contact	changeover contact

DEHNshield TN Basic FM

Application-optimised and prewired combined lightning current and surge arrester for single-phase TN systems for use in the main power supply system (2+0 configuration) in case of residential buildings without external lightning protection system (also in case of buildings supplied by overhead lines); with floating remote signalling contact.



Type DSH ...	B TN 255 FM
Part No.	941 206
SPD according to EN 61643-11 / IEC 61643-11	type 1 + type 2 / class I + class II
Max. continuous operating voltage (a.c.) (U_c)	255 V (50 / 60 Hz)
Lightning impulse current (10/350 μ s) [L+N-PE] (I_{total})	15 kA
Lightning impulse current (10/350 μ s) [L, N-PE] (I_{imp})	7.5 kA
Voltage protection level [L-PE]/[N-PE] (U_p)	$\leq 1.5 / \leq 1.5$ kV
Max. mains-side overcurrent protection	160 A gG
Type of remote signalling contact	changeover contact

DEHNshield TT 2P

Application-optimised and prewired combined lightning current and surge arrester for single-phase TT and TN systems with a nominal voltage of 230 V (1+1 configuration).

Type DSH ...	TT 2P 255
Part No.	941 110
SPD according to EN 61643-11 / IEC 61643-11	type 1 + type 2 / class I + class II
Max. continuous operating voltage (a.c.) (U_c)	255 V (50 / 60 Hz)
Lightning impulse current (10/350 μ s) [L+N-PE] (I_{total})	25 kA
Lightning impulse current (10/350 μ s) [L-N]/[N-PE] (I_{imp})	12.5 / 25 kA
Voltage protection level [L-N]/[N-PE] (U_p)	$\leq 1.5 / \leq 1.5$ kV
Max. mains-side overcurrent protection	160 A gG
Approvals	KEMA, VDE, UL
Extended technical data:	
Voltage protection level [L-PE] (U_p)	2.0 kV



DEHNshield TT 2P FM

Application-optimised and prewired combined lightning current and surge arrester for single-phase TT and TN systems with a nominal voltage of 230 V (1+1 configuration); with floating remote signalling contact.

Type DSH ...	TT 2P 255 FM
Part No.	941 115
SPD according to EN 61643-11 / IEC 61643-11	type 1 + type 2 / class I + class II
Max. continuous operating voltage (a.c.) (U_c)	255 V (50 / 60 Hz)
Lightning impulse current (10/350 μ s) [L+N-PE] (I_{total})	25 kA
Lightning impulse current (10/350 μ s) [L-N]/[N-PE] (I_{imp})	12.5 / 25 kA
Voltage protection level [L-N]/[N-PE] (U_p)	$\leq 1.5 / \leq 1.5$ kV
Max. mains-side overcurrent protection	160 A gG
Approvals	KEMA, VDE
Type of remote signalling contact	changeover contact
Extended technical data:	
Voltage protection level [L-PE] (U_p)	2.0 kV



DEHNshield TT 2P Basic FM

Application-optimised and prewired combined lightning current and surge arrester for single-phase TT and TN-S systems for use in the main power supply system (1+1 configuration) in case of residential buildings without external lightning protection system (also in case of buildings supplied by overhead lines); with floating remote signalling contact.

Type DSH ...	B TT 2P 255 FM
Part No.	941 116 ^{NEW}
SPD according to EN 61643-11 / IEC 61643-11	type 1 + type 2 / class I + class II
Max. continuous operating voltage (a.c.) (U_c)	255 V (50 / 60 Hz)
Lightning impulse current (10/350 μ s) [L+N-PE] (I_{total})	15 kA
Lightning impulse current (10/350 μ s) [L-N]/[N-PE] (I_{imp})	7.5 / 15 kA
Voltage protection level [L-N]/[N-PE] (U_p)	$\leq 1.5 / \leq 1.5$ kV
Max. mains-side overcurrent protection	160 A gG
Type of remote signalling contact	changeover contact
Extended technical data:	
Voltage protection level [L-PE] (U_p)	2.0 kV



DEHNcombo



For protecting photovoltaic inverters against surges and even direct lightning strikes. For use in accordance with IEC 60364-7-712 (Installation of photovoltaic power supply systems).

- Prewired type 1 + type 2 combined lightning current and surge arrester for use in photovoltaic generator circuits
- Approved fault-resistant Y circuit prevents damage to the surge protective device in case of insulation faults in the generator circuit
- Rated voltage is the same for all modes of protection and, therefore, the arrester can also be used in earthed systems
- Space-saving enclosure with a width of only four modules for up to 1500 V d.c.
- Tested to IEC 61643-31 / EN 61643-31 / EN 50539-11
- Applicable in PV systems in accordance with IEC 60364-7-712
- Operating state / fault indication by green / red indicator flag in the inspection window

DEHNcombo DCB YPV 1200: Two-pole combined lightning current and surge arrester for use in photovoltaic power supply systems up to 1200 V d.c.

DEHNcombo DCB YPV 1500: Two-pole combined lightning current and surge arrester for use in photovoltaic power supply systems up to 1500 V d.c.

DEHNcombo YPV SCI ... FM: With remote signalling contact for monitoring device (floating changeover contact)

The DEHNcombo YPV ... combined arrester protects equipment in photovoltaic systems against lightning currents.

Thanks to its application-optimised discharge capacity of 6.25 kA (10/350 µs) per pole, DEHNcombo is tailored to meet the requirements of the latest version of the EN 50539-12 standard and Supplement 5 of the German DIN EN 62305-3 standard.

With a short-circuit current rating of 10 kA, DEHNcombo easily meets all requirements placed on surge arresters in small, medium and large photovoltaic systems and can be used without backup fuse in all photovoltaic systems up to 10 kA.

Due to its enclosure design which is specifically adapted to the system-specific requirements, even the version for voltages up to 1500 V can be used without taking special precautions (e.g. safety distances). The combined arrester has a width of only four modules, thus allowing space-saving installation.

The rated voltage of the new DEHNcombo is the same for all modes of protection and, therefore, the arrester can also be used in earthed systems. 1200 V and 1500 V versions are available, covering the most common voltage levels of photovoltaic systems.

The fault-resistant Y circuit further reduces the probability of an arrester failure in case of the operating and fault states which have to be considered in photovoltaic systems. This ensures reliable operation of the PV system at all times.

An important requirement in PV systems is the low power consumption of the devices. A criterium which is met by the current free operating state and fault indication, which instantly provides information on the operating state of the arrester. The optional remote signalling contact is designed as a floating changeover contact and can, depending on the circuit concept, be used as a make or break contact.

DEHNcombo YPV ...

Combined lightning current and surge arrester for use in photovoltaic power supply systems up to 1500 V d.c.

NEW



Type DCB YPV ...	1200	1500
Part No.	900 070 <small>NEW</small>	900 071 <small>NEW</small>
SPD according to EN 50539-11	type 1 + type 2	type 1 + type 2
Max. PV voltage [DC+ -> DC-] (U _{CPV})	≤ 1200 V	≤ 1500 V
Short-circuit current rating (I _{SCPV})	10 kA	10 kA
Total discharge current (10/350 µs) [DC+/DC- -> PE] (I _{total})	12.5 kA	12.5 kA
Lightning impulse current (10/350 µs) [DC+ -> PE/DC- -> PE] (I _{imp})	6.25 kA	6.25 kA
Voltage protection level [(DC+/DC-) -> PE] (U _p)	< 3.8 kV	< 4.5 kV
Approvals	KEMA, UL	KEMA, UL

DEHNcombo YPV ... FM

Combined lightning current and surge arrester for use in photovoltaic power supply systems up to 1500 V d.c.; with floating remote signalling contact.

NEW



Type DCB YPV ...	1200 FM	1500 FM
Part No.	900 075 <small>NEW</small>	900 076 <small>NEW</small>
SPD according to EN 50539-11	type 1 + type 2	type 1 + type 2
Max. PV voltage [DC+ -> DC-] (U _{CPV})	≤ 1200 V	≤ 1500 V
Short-circuit current rating (I _{SCPV})	10 kA	10 kA
Total discharge current (10/350 µs) [DC+/DC- -> PE] (I _{total})	12.5 kA	12.5 kA
Lightning impulse current (10/350 µs) [DC+ -> PE/DC- -> PE] (I _{imp})	6.25 kA	6.25 kA
Voltage protection level [(DC+/DC-) -> PE] (U _p)	< 3.8 kV	< 4.5 kV
Approvals	KEMA, UL	KEMA, UL
Type of remote signalling contact	Changeover contact	Changeover contact

DEHNSolid

- Coordinated spark-gap-based lightning current arrester
- Extremely high lightning current discharge capacity up to 200 kA (10/350 μ s)
- Low voltage protection level $U_p \leq 2.5$ kV
- Extremely robust design for installation on busbars or mounting plates



For protecting low-voltage consumer installations against surges and even direct lightning strikes. For installation in conformity with the lightning protection zone concept at the boundaries from $0_A - 1$.

DSO 1 255: Coordinated single-pole lightning current arrester with an extremely high lightning current discharge capacity

The spark gap of the coordinated DEHNSolid lightning current arrester has an extremely high lightning current discharge capacity of 200 kA (10/350 μ s), making DEHNSolid the most powerful lightning current arrester currently available on the market. Consequently, a technical solution is now available for applications where such powerful surge protective devices are required. The device ensures lightning protection if the lightning current is not distributed and thus the full lightning current may flow through the surge protective device. If a lightning protection level higher than LPL I according to EN 62305 is to be expected, DEHNSolid offers adequate protection.

DEHNSolid features a robust design due to its extreme installation conditions and can be installed in two different ways. On the one hand, the arrester can be directly mounted on the busbar. This ensures a mechanically stable installation, which is required in case of such extreme lightning currents due to the high forces, and short low-impedance connections. On the other hand, the arrester can be screwed onto a mounting plate / fixing unit using the fixing lugs if it is not possible to install it on a busbar. Extremely short and robust connecting cables are required for this device to ensure the mechanical strength of the entire arrangement and a minimum voltage drop on the connecting cables to achieve an optimal voltage protection level for the installation.

DEHNSolid 1 255

Coordinated single-pole lightning current arrester for use in 230/400 V systems; for installation on busbars or mounting plates.

Type	DSO 1 255
Part No.	900 230
Classification according to EN 61643-11 / IEC 61643-11	type 1 / class I
Max. continuous operating voltage (a.c.) (U_c)	255 V (50 / 60 Hz)
Lightning impulse current (10/350 μ s) (I_{imp})	200 kA
Voltage protection level (U_p)	≤ 2.5 kV
Max. mains-side overcurrent protection	160 A gG



DEHNbloc modular

For protecting low-voltage consumer installations against surges and even direct lightning strikes. For installation in conformity with the lightning protection zone concept at the boundaries from $0_A - 1$.

- Coordinated spark-gap-based lightning current arrester consisting of a base part and a plug-in protection module
- Maximum system availability due to RADAX Flow follow current limitation
- No tripping of 32 A gG fuses up to short-circuit currents of 50 kA_{rms}
- Discharge capacity up to 50 kA (10/350 μs)
- Directly coordinated with DEHNguard surge protective devices without additional cable length
- Low voltage protection level
- Operating state / fault indication by green / red indicator flag in the inspection window
- Easy replacement of protection modules without tools due to module locking system with module release button

DEHNbloc M 1 ...: Coordinated and modular single-pole lightning current arrester with high follow current limitation

DEHNbloc M 1 ... FM: With remote signalling contact for monitoring device (floating changeover contact)

The modular devices of the DEHNbloc M product family are coordinated lightning current arresters with a functional design.

Energy coordination with type 2 surge arresters of the DEHNguard family is ensured without additional cable lengths or decoupling coils. This is one of the most important features of the Red/Line product families.

The DEHNbloc M arresters combine high performance and ease of use in a single device. Their electrical parameters are rated for the most stringent requirements within lightning and surge protection systems. DEHNbloc M is ideally suited for use in the main distribution board of the low-voltage consumer's installation of a building. Equipped with the latest RADAX Flow spark gap technology, the protection and availability of electrical installations is a top priority of DEHNbloc M.

Due to the unique follow current limitation and extinction, fuses are not tripped by follow currents even in case of low-current-rated fuses in the installation. The leakage-current-free protective circuit and the mechanical operating state indicator allow the device to be installed even in areas upstream of meter panels in low-voltage consumer installations.

The modular design of the DEHNbloc M arresters makes them safe and easy to use. Their vibration-proof module locking system, for example, is unique. Shock or vibration during transport or operation or enormous mechanical impulse loads resulting from discharges do not affect the module locking system which ensures safe fixation both for the base part and protection module. Nevertheless, the protection modules can be easily replaced without tools by simply pressing the easy-to-use module release button. Both the base part and protection module are mechanically coded to avoid installing an incorrect module. DEHNbloc M devices incorporate double terminals, allowing series connection of the arresters in a space-saving and cost-effective way according to IEC 60364-5-53 requirements for nominal currents up to 125 A.

The operating state / fault indicator of DEHNbloc M does not cause operating currents and instantly shows the operating state of the device. Apart from the standard visual indicator with red and green indicator flags, DEHNbloc M ... FM devices feature an additional remote signalling output. As the remote signalling contact is designed as a floating changeover contact, the remote signal can, depending on the circuit concept, be used as a make or break contact.

DEHNbloc M 1 ...

Coordinated and modular single-pole lightning current arrester with a high discharge capacity.



Type DB M 1 ...	150	255	320
Part No.	961 110	961 120	961 130
SPD according to EN 61643-11 / IEC 61643-11	type 1 / class I	type 1 / class I	type 1 / class I
Max. continuous operating voltage (a.c.) (U _c)	150 V (50 / 60 Hz)	255 V (50 / 60 Hz)	320 V (50 / 60 Hz)
Lightning impulse current (10/350 μs) (I _{imp})	35 kA	50 kA	25 kA
Voltage protection level (U _p)	≤ 1.5 kV	≤ 2.5 kV	≤ 2.5 kV
Max. backup fuse (L) up to I _k = 50 kA _{rms} (t _a ≤ 0.2 s)	—	500 A gG	315 A gG
Max. backup fuse (L) up to I _k = 50 kA _{rms} (t _a ≤ 5 s)	—	315 A gG	315 A gG
Max. backup fuse (L) up to I _k = 35 kA _{rms} (t _a ≤ 0.2 s)	500 A gG	—	—
Max. backup fuse (L) up to I _k = 35 kA _{rms} (t _a ≤ 5 s)	315 A gG	—	—
Approvals	UL, CSA	VDE, KEMA, UL	UL

DEHNbloc M 1 ... FM

Coordinated and modular single-pole lightning current arrester with a high discharge capacity; with remote signalling contact for monitoring system (floating changeover contact).



Type DB M 1 ...	150 FM	255 FM	320 FM
Part No.	961 115	961 125	961 135
SPD according to EN 61643-11 / IEC 61643-11	type 1 / class I	type 1 / class I	type 1 / class I
Max. continuous operating voltage (a.c.) (U _c)	150 V (50 / 60 Hz)	255 V (50 / 60 Hz)	320 V (50 / 60 Hz)
Lightning impulse current (10/350 μs) (I _{imp})	35 kA	50 kA	25 kA
Voltage protection level (U _p)	≤ 1.5 kV	≤ 2.5 kV	≤ 2.5 kV
Max. backup fuse (L) up to I _k = 50 kA _{rms} (t _a ≤ 0.2 s)	—	500 A gG	315 A gG
Max. backup fuse (L) up to I _k = 50 kA _{rms} (t _a ≤ 5 s)	—	315 A gG	315 A gG
Max. backup fuse (L) up to I _k = 35 kA _{rms} (t _a ≤ 0.2 s)	500 A gG	—	—
Max. backup fuse (L) up to I _k = 35 kA _{rms} (t _a ≤ 5 s)	315 A gG	—	—
Approvals	UL, CSA	VDE, KEMA, UL	UL

Protection Module for DEHNbloc modular

- High discharge capacity due to powerful creepage discharge spark gap
- Maximum system availability due to RADAX Flow follow current limitation
- Easy replacement of protection modules without tools due to module locking system with module release button
- Operating state / fault indication by green / red indicator flag in the inspection window
- The plug-in protection module can be replaced without switching off the mains voltage or removing the vertical cover



DB M MOD ...: Spark-gap-based protection module

For protecting low-voltage consumer installations against surges and even direct lightning strikes. For installation in conformity with the lightning protection zone concept at the boundaries from $0_A - 1$.

The spark-gap-based protection modules for devices of the DEHNbloc M family incorporate the complete protective circuit including the RADAX Flow spark gap and the monitoring circuit for controlling the energy flow. The spark gap monitoring system and the operating state / fault indicator are also housed in the protection module. Every protection module is mechanically coded to avoid installing an incorrect replacement module.

As with all modular protective devices, protection modules can be easily replaced without tools by simply pressing the module release button. Avoid additional, short-notice and unplanned maintenance jobs. In multipole protective circuits, we recommend replacing the complete set of protection modules when one module fails.

Type DB M MOD ...	150	255	320
Part No.	961 001	961 002	961 003
Max. continuous operating voltage (a.c.) (U_c)	150 V	255 V	320 V
Lightning impulse current (10/350 μ s) (I_{imp})	35 kA	50 kA	25 kA



DEHNbloc modular for North America

- High discharge current capacity due to powerful creepage discharge spark gap
- Directly coordinated with DEHNguard MU surge protective devices without additional cable length
- ANSI/UL 1449 – 4th Ed. open type 1 surge protection device (SPD)



DEHNbloc MU 3PY 208 3W+G R: Modular lightning current arrester for application in 3 phase Wye 208 Y/120 V electrical systems
DEHNbloc MU 3PY 480 3W+G R: Modular lightning current arrester for application in 3 phase Wye 480 Y/277 V electrical systems
DEHNbloc MU ... R: With remote status indicator for monitoring device (Form C/SPDT contact)

DEHNbloc MU 3PY ... 3W+G

DIN rail mount, pluggable lightning current arrester consisting of a base part and plug-in protection modules for application in 3 Phase Wye electrical systems.

Type DB MU 3PY ...	208 3W+G R	480 3W+G R
Part No.	908 505	908 506
SPD classification acc. to ANSI/UL 1449 4 th Ed.	Open-Type 1 SPD	Open-Type 1 SPD
Max. continuous operating voltage [L-G] / [L-L] (MCOV)	150 V a.c. / 260 V a.c.	320 V a.c. / 555 V a.c.
Lightning impulse current (10x350 μ s) (I_{imp})	35 kA	25 kA
Voltage protection rating [L-G] / [L-L] (VPR)	1500 V _{pk} / 2500 V _{pk}	1800 V _{pk} / 3000 V _{pk}
Approvals	UL	UL
Remote status contact	Floating (dry), Form C (SPDT)	Floating (dry), Form C (SPDT)



DEHNbloc Maxi



- Encapsulated RADAX Flow spark gap with high follow current limitation
- No tripping of 32 A gG fuses up to short-circuit currents of 50 kA_{rms}
- High lightning current discharge capacity
- Directly coordinated with DEHNguard ... and V(A) NH ... surge protective devices without additional cable length
- NH00 design
- Low voltage protection level

For protecting low voltage consumer installations against surges and even direct lightning strikes. For installation in conformity with the lightning protection zone concept at the boundaries from 0_A – 1.

DBM NH00 255: Coordinated single-pole lightning current arrester in NH00 design with high follow current limitation for U_c = 255 V

The coordinated DEHNbloc Maxi ... lightning current arresters adapt themselves to every kind of application. Whether being used in an exposed position or in harsh industrial environments: DEHNbloc Maxi ... always offers the right solution. The single-pole devices are coordinated with the proven DEHNguard and V(A) NH surge arresters of the Red/Line family. Irrespective of cable lengths and without requiring additional decoupling coils, the surge protection concept can be adapted individually to the special conditions of the installation.

DEHNbloc Maxi arresters provide the patented encapsulated creepage discharge spark gap and RADAX Flow follow current limitation. This means that special safety distances from busbars or other equipment are not required and backup fuses are not tripped due to a lack of selectivity between the protective device and any overcurrent protection system, thus ensuring maximum system availability.

DEHNbloc Maxi NH00 255 was specifically designed for industrial distribution boards and supply systems and allows compact and space-saving installation in NH00 fuse holders or disconnectors depending on the particular system.



Lightning Current Arresters – Type 1

DEHNbloc Maxi NH00 255

Coordinated single-pole lightning current arrester in NH00 design for TN-C and TN-S systems with a nominal voltage of 230/400 V.



Type	DBM NH00 255
Part No.	900 255
SPD according to EN 61643-11 / IEC 61643-11	type 1 / class I
Max. continuous operating voltage (a.c.) (U _c)	255 V (50 / 60 Hz)
Lightning impulse current (10/350 μs) (I _{imp})	25 kA
Voltage protection level (U _p)	≤ 2.5 kV
Max. backup fuse (L) up to I _k = 50 kA _{rms}	315 A gG

DEHNbloc Maxi 1 CI 440 / 760 FM

- Spark-gap-based lightning current arrester with integrated lightning current carrying backup fuse in a compact enclosure
- Extremely high lightning current discharge capacity of 35 kA (10/350 μ s)
- Low voltage protection level (including backup fuse)
- High follow current extinguishing capability and limitation thanks to RADAX Flow technology
- Energy coordination with other arresters of the Red/Line product family
- Operating state / fault indication by green / red indicator flag in the inspection window



For protecting low-voltage consumer installations against surges and even direct lightning strikes. For installation in conformity with the lightning protection zone concept at the boundaries from $0_A - 1$.

DEHNbloc Maxi 1 CI 440 FM: Coordinated single-pole lightning current arrester with integrated backup fuse, high follow current extinguishing capability and remote signalling contact for monitoring device (floating changeover contact) for $U_c = 440$ V

DEHNbloc Maxi 1 CI 760 FM: Coordinated single-pole lightning current arrester with integrated backup fuse, high follow current extinguishing capability and remote signalling contact for monitoring device (floating changeover contact) for $U_c = 760$ V

The coordinated DEHNbloc Maxi CI 440 and 760 lightning current arresters are specifically designed for higher system voltages, thus efficiently protecting installations from the effects of direct lightning strikes and surges. The features of the proven DEHNbloc Maxi device series and a lightning current carrying arrester backup fuse are combined in the compact enclosure with a width of three standard modules and therefore the devices require up to 60 % less space than a conventional solution.

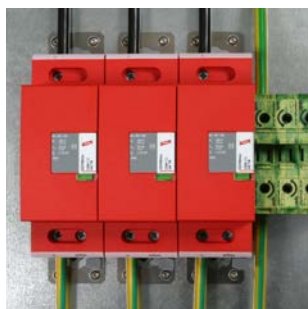

Flexible installation using mounting brackets

Due to the increasingly compact design of system applications, the installation of lightning current arresters in accordance with standards is becoming more and more difficult for the user. The DEHNbloc Maxi CI not only fulfils requirements in terms of the space-saving integration of a type 1 arrester, but also the protection requirements of modern switchgear installations.

Typical fields of application of this arrester are industrial plants with common nominal voltages of 400 / 690 V, IT systems of the chemical industry with nominal voltages of 500 V a.c., protection of the transformer on the low-voltage side of wind turbines and protection of the a.c. side of central inverters of photovoltaic systems.

The integrated backup fuse is dimensioned to ensure maximum discharge capacity and optimal system protection. Consequently, the need to select and install an adequate arrester backup fuse is eliminated, ensuring short connecting cable lengths as required in the IEC 60364-5-53 standard.

The proven spark gaps with wave breaker function and RADAX Flow technology are the core of the coordinated DEHNbloc Maxi CI 440 and 760 lightning current arresters. In case of spark-gap-based type 1 arresters, the full current flows through the type 1 arrester during the discharge process; similar to a wave breaker, the destructive energy is mitigated to a sufficiently low level, thus considerably relieving the downstream SPDs and the entire electrical installation. In addition to this wave breaker function, the RADAX Flow technology reduces and extinguishes mains follow currents to such a low level that even a 32 A gG fuse does not trip. This ensures high availability and longevity of the electrical installation.

The new enclosure concept allows flexible installation. Due to the typical installation environment, DEHNbloc Maxi CI is delivered with two mounting brackets so that the arresters can also be directly fixed on a mounting plate. However, the arresters can, of course, also be mounted on a DIN rail.

The operating state / fault indication of DEHNbloc Maxi CI, which also includes the fuse monitoring, does not cause operating currents and instantly shows the status of the devices. Apart from the standard visual indicator with green and red flags, the devices feature a three-pole remote signalling terminal. As the remote signalling contact is designed as a floating changeover contact, the remote signal can, depending on the circuit concept, be used as a make or break contact.

DEHNbloc Maxi 1 CI 440 FM

Coordinated single-pole lightning current arrester with integrated backup fuse for 400/690 V TN systems and 400 V IT systems; with remote signalling contact for monitoring device (floating changeover contact).



Type DBM 1 CI ...	440 FM
Part No.	961 146
SPD according to EN 61643-11 / IEC 61643-11	type 1 / class I
Maximum continuous operating voltage (a.c.) (U_C)	440 V (50 / 60 Hz)
Lightning impulse current (10/350 μ s) (I_{imp})	35 kA
Voltage protection level (U_p)	≤ 2.5 kV
Max. mains-side overcurrent protection	not required
Type of remote signalling contact	changeover contact

DEHNbloc Maxi 1 CI 760 FM

Coordinated single-pole lightning current arrester with integrated backup fuse for 690 V TN / IT systems; with remote signalling contact for monitoring device (floating changeover contact).



Type DBM 1 CI ...	760 FM
Part No.	961 176
SPD according to EN 61643-11 / IEC 61643-11	type 1 / class I
Maximum continuous operating voltage (a.c.) (U_C)	760 V (50 / 60 Hz)
Lightning impulse current (10/350 μ s) (I_{imp})	35 kA
Voltage protection level (U_p)	≤ 4 kV
Max. mains-side overcurrent protection	not required
Type of remote signalling contact	changeover contact

Accessories for DEHNbloc Maxi 1 CI 440 / 760 FM

Earthing Clip for three-module Enclosures, single-phase, three-pole

Earthing clip for connecting the earth terminal of e.g. three SPDs with three-module enclosure to earth, with terminal.



Type	EB 1 3 10
Part No.	900 461
Dimensions	34 x 158 x 28 mm
Terminal	up to 25 mm ²

Earthing Clip for three-module Enclosures, single-phase, four-pole

Earthing clip for connecting the earth terminal of e.g. four SPDs with three-module enclosure to earth, with terminal.



Type	EB 1 4 13
Part No.	900 462
Dimensions	34 x 212 x 28 mm
Terminal	up to 25 mm ²

DEHNbloc Maxi 440 / 760

- Spark-gap-based lightning current arrester
- Extremely high lightning current discharge capacity
- High follow current extinguishing capability and limitation due RADAX Flow technology
- Directly coordinated with DEHNguard surge protective devices without additional cable length
- Operating state / fault indication by green / red indicator flag in the inspection window



For protecting low-voltage consumer installations against surges and even direct lightning strikes. For installation in conformity with the lightning protection zone concept at the boundaries from $0_A - 1$.

- DEHNbloc Maxi 1 440:** Coordinated single-pole lightning current arrester with high follow current limitation for $U_c = 440 \text{ V}$
- DEHNbloc Maxi 1 440 FM:** With remote signalling contact for monitoring device (floating changeover contact)
- DEHNbloc Maxi 1 760 FM:** Coordinated single-pole lightning current arrester with high follow current limitation for $U_c = 760 \text{ V}$
With remote signalling contact for monitoring device (floating changeover contact)

The coordinated DEHNbloc Maxi 440 and 760 lightning current arresters are specifically designed for high system voltages.

For a large number of industrial applications, this makes effective protection against direct and indirect lightning currents possible.

Be it in a wind turbine or a stand-alone low-voltage installation of an industrial enterprise, DEHNbloc Maxi devices effortlessly fulfil the specified requirements.

Both the design of the protective circuit and the enclosure specifically designed for this type of arrester are particularly adapted to high system voltages.

The proven RADAX Flow technology is the core element of the coordinated DEHNbloc Maxi 440 and 760 lightning current arresters. What makes these devices special is their ability to considerably limit mains follow currents and extinguish them within just a few milliseconds.

The patented RADAX Flow follow current limitation ensures that low-value fuses are not tripped by follow currents.

The ability to discharge lightning currents without destruction and to suppress mains follow currents without tripping upstream overcurrent protective devices ensures a high degree of availability in electrical installations.

The operating state / fault indicator of the coordinated lightning current arresters does not cause operating currents and immediately shows the operating state of the devices. Apart from the standard visual indication with green and red indicator flags, DEHNbloc Maxi 1 ... FM features a three-pole remote signalling terminal. As the remote signalling contact is designed as a floating changeover contact, the remote signal can, depending on the circuit concept, be used as a make or break contact.



DEHNbloc Maxi 1 440 (FM)

Coordinated single-pole lightning current arrester for use in 400/690 V systems; FM version with floating remote signalling contact.



Type DBM 1 ...	440	440 FM
Part No.	961 140	961 145
SPD according to EN 61643-11 / IEC 61643-11	type 1 / class I	type 1 / class I
Max. continuous operating voltage (a.c.) (U_c)	440 V	440 V
Lightning impulse current (10/350 μ s) (I_{imp})	35 kA	35 kA
Voltage protection level (U_p)	≤ 2.5 kV	≤ 2.5 kV
Max. backup fuse (L) up to $I_k = 50$ kA _{rms} ($t_a \leq 0.2$ s)	500 A gG	500 A gG
Max. backup fuse (L) up to $I_k = 50$ kA _{rms} ($t_a \leq 5$ s)	250 A gG	250 A gG
Approvals	UL, CSA	UL, CSA
Type of remote signalling contact	—	changeover contact

DEHNbloc Maxi 1 760 FM

Coordinated single-pole lightning current arrester for use in 690 V systems; with remote signalling contact for monitoring device (floating changeover contact).



Type DBM 1 ...	760 FM
Part No.	961 175
SPD according to EN 61643-11 / IEC 61643-11	type 1 / class I
Max. continuous operating voltage (a.c.) (U_c)	760 V
Lightning impulse current (10/350 μ s) (I_{imp})	25 kA
Voltage protection level (U_p)	≤ 4 kV
Max. backup fuse (L) up to $I_k = 25$ kA _{rms} ($t_a \leq 5$ s)	250 A gG
Approvals	UL, CSA
Type of remote signalling contact	changeover contact

Accessories for DEHNbloc Maxi 440 / 760

Earthing Clip for two-module Enclosures, single-phase, three-pole

Earthing clip for connecting the earth terminal of e.g. three SPDs with two-module enclosure to earth, with terminal.



Type	EB DG 1000 1 3
Part No.	900 411
Dimensions	34 x 112 x 28 mm
Terminal	up to 25 mm ²

Earthing Clip for two-module Enclosures, single-phase, four-pole

Earthing clip for connecting the earth terminal of e.g. four SPDs with two-module enclosure to earth, with terminal.



Type	EB 1 4 9
Part No.	900 417
Dimensions	34 x 148 x 28 mm
Terminal	up to 25 mm ²

DEHNbloc Maxi S

- Spark-gap-based lightning current arrester with integrated lightning current carrying backup fuse in a compact enclosure
- Directly mounted on the PEN / N busbar
- Low voltage protection level $U_p \leq 2.5$ kV (including 80 cm connecting cable)
- Directly coordinated with DEHNguard surge protective device without additional cable length
- Short-circuit withstand capability of $100 \text{ kA}_{\text{rms}}$ ($220 \text{ kA}_{\text{peak}}$)
- High follow current extinguishing capability and limitation due to RADAX Flow technology
- High lightning current discharge capacity
- With optical-fibre interface for SPD monitoring



For protecting low voltage consumer installations against surges and even direct lightning strikes. For installation in conformity with the lightning protection zone concept at the boundaries from $0_A - 1$.

DEHNbloc Maxi 1 255 S: Coordinated lightning current arrester with integrated backup fuse for busbar installation

DEHNbloc Maxi S can be easily integrated into the application environment of a low-voltage switchgear installation or distribution board.

Thanks to its unique mechanical design, the coordinated DEHNbloc Maxi S lightning current arrester can be directly mounted on the PEN/N busbar of a switchgear installation without the need for additional adapters.

With the backup fuse integrated in the device, no other separate backup fuses need to be installed.

Installing DEHNbloc Maxi S directly into the connection panel of a switchgear installation upstream of the circuit breaker ensures short cable lengths of the arresters and a low voltage protection level for the installation. In this environment, the VDE-tested DEHNbloc Maxi S can be used for short-circuit currents up to $100 \text{ kA}_{\text{rms}}$.

With a discharge capacity of 25 kA ($10/350 \mu\text{s}$), DEHNbloc Maxi S fulfils the highest national and international lightning protection standards for all three-phase current applications in TN and TT systems.

For 3+1 configurations, DEHNgap Maxi S provides a powerful creepage discharge spark gap with a discharge capacity of 100 kA ($10/350 \mu\text{s}$).

DEHNbloc Maxi S also features patented RADAX Flow follow current limitation, thus ensuring selectivity even in case of low-current-rated fuses.

The ability to conduct lightning impulse currents without destruction and to suppress mains follow currents without tripping upstream overcurrent protective devices ensures the availability of the switchgear installation in the event of a lightning strike. This considerably reduces the risk of arc formation in the installation.

In conjunction with the DEHNSignal remote signalling system, the operating state of DEHNbloc Maxi S devices can be monitored at any time.

Easy-to-implement optical fibre transmission to the DEHNSignal E 3 remote signalling receiver module ensures safe electrical isolation between the power circuit and the remote signalling circuit.

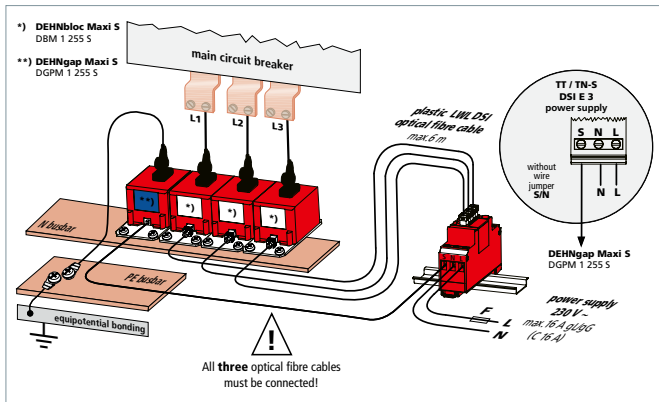

3+1 application in a TT / TN-S system

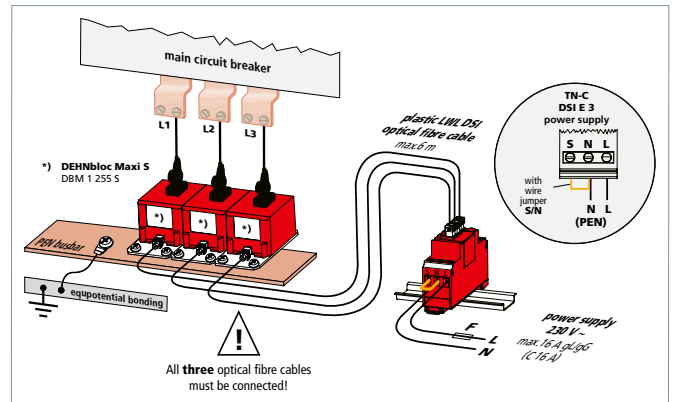

3-0 application in a TN-C system

DEHNbloc Maxi 1 255 S

Coordinated single-pole lightning current arrester with integrated backup fuse for busbar installation in 230/400 V systems.

Type	DBM 1 255 S
Part No.	900 220
SPD according to EN 61643-11 / IEC 61643-11	type 1 / class I
Max. continuous operating voltage (a.c.) (U_c)	255 V (50 / 60 Hz)
Lightning impulse current ($10/350 \mu\text{s}$) (I_{imp})	25 kA
Voltage protection level (U_p)	≤ 2.5 kV (including 80 cm connecting cable)
Max. mains-side overcurrent protection	not required
Operating state indication	by optical fibre cables via DSI E 3





DEHNSignal

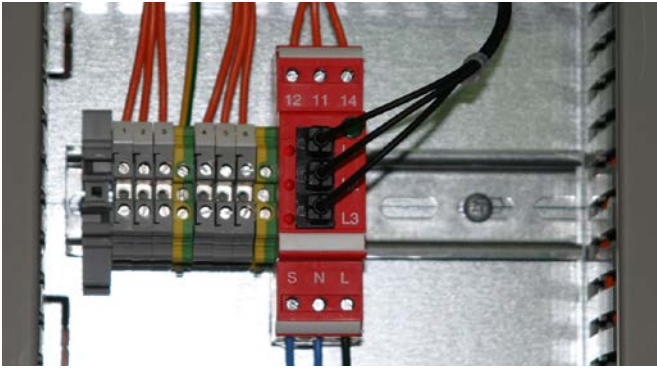

Receiver module for optical transmission with floating changeover contact for DEHNBloc Maxi S and DEHNGap Maxi S surge protective devices.

- Operating state indication of the surge protective device connected
- Indication of phase failures
- Floating changeover contact
- Selective operating state indication
- Centralised fault indication

DEHNSignal E 3: Receiver module for optical transmission for selective operating state indication/centralised fault indication of three coordinated DEHNBloc Maxi S and, where appropriate, DEHNGap Maxi S lightning current arresters in five-wire systems

The DEHNSignal E 3 receiver module for optical transmission transmits remote signals of DEHNBloc Maxi S and DEHNGap Maxi S surge protective devices.

The DEHNSignal E 3 receiver module is particularly adapted to the place of installation of the coordinated DEHNBloc Maxi S and DEHNGap Maxi S lightning current arresters.

Three DEHNBloc Maxi S arresters and, if necessary, the N-PE protective circuit can be remotely monitored by the receiver module via optical fibre cables.

In view of the special installation environment of surge protective devices in a switchgear installation, communication via optical fibre cable between the protective devices and the DEHNSignal E 3 receiver module is a considerable safety benefit.

The operating states of the individual arresters are transmitted to the DEHNSignal E 3 receiver module in the form of an optical signal via EMC-resistant plastic optical fibre cables. The optical signals are evaluated in the DEHNSignal E 3 receiver module and are converted into an electrical signal. The operating states can be directly read at the DEHNSignal E 3

receiver module or can be transmitted via a floating changeover contact. The DEHNSignal E 3 receiver module features a green indicator light to check its operating state. In addition to the operating state indication, the three red indicator lights of the selective operating state indication indicate the operating states of the assigned protective devices. The receiver module signals if a protective device of a phase fails. The surge protective devices and the DEHNSignal E 3 receiver module can be easily connected via optical fibre cable using the accessories described.

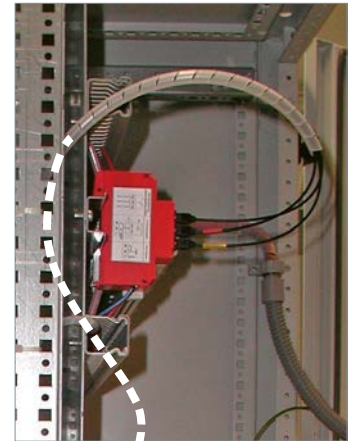

DEHNSignal E 3

Receiver module for optical transmission for selective operating state indication/centralised fault indication of three coordinated DEHNBloc Maxi S and, where appropriate, DEHNGap Maxi S lightning current arresters in five-wire systems.



Type	DSI E 3
Part No.	910 631
Supply voltage (a.c.) (U _N)	230 V
Power input (P)	< 550 mW
Backup fuse for supply voltage	16 A gG or C 16 A
Signal input	3x via optical fibre plug-in system (LWL ST DSI)
Type of remote signalling contact	floating changeover contact
Test standards	EN 61010-1:1993 and EN 61010-1/A2:1995

Accessories for DEHNSignal

LWL ST DSI

Plug for plastic optical fibre cables.



Type	LWL ST DSI
Part No.	910 641
Diameter	2.2 mm

LWL DSI 18M

18 metres of plastic optical fibre cable, preferably for use with DEHNBloc Maxi S.



Type	LWL DSI 18M
Part No.	910 642
Diameter	2.2 mm
Length	18 m

DEHNsecure modular

- Coordinated spark-gap-based lightning current arrester consisting of a base part and a plug-in protection module
- Spark gap technology particularly suited for use in d.c. circuits
- High lightning current discharge capacity of 25 kA (10/350 μ s)
- Directly coordinated with DEHNguard SE DC ... surge protective devices
- Low voltage protection level
- Operating state / fault indication by green / red indicator flag in the inspection window
- Easy replacement of protection modules due to module locking system with module release button



For protecting d.c. consumer installations against surges and even direct lightning strikes. For installation in conformity with the lightning protection zone concept at the boundaries from $0_A - 1$.

- DEHNsecure M 1 ...: Coordinated and modular single-pole lightning current arrester for d.c. applications
- DEHNsecure M 1 ... FM: With remote signalling contact for monitoring device (floating changeover contact)
- DEHNsecure M 2P ...: Coordinated and modular two-pole lightning current arrester for d.c. applications
- DEHNsecure M 2P ... FM: With remote signalling contact for monitoring device (floating changeover contact)

The modular devices of the DEHNsecure product family are coordinated lightning current arresters with a functional design.

They can be energy-coordinated with type 2 surge arresters of the DEHNguard SE DC family.

The DEHNsecure arresters combine high performance and ease of use in a single device. Their electrical parameters are rated for the most stringent requirements in lightning and surge protection systems.

The internal structure of the DEHNsecure spark gap is suited for use in d.c. circuits. The device concept prevents mains follow currents up to 25,000 A d.c. from occurring.

With this new arrester series, a consistent lightning protection zone concept including the cross-boundary d.c. lines can now be implemented.

Furthermore, the leakage-current-free version of the spark-gap-based arrester offers numerous advantages when used in insulation monitored systems or in applications where the highest demands are placed on self-energy consumption.

DEHNsecure arresters are used, for example, in safety lighting systems, emergency power supplies, d.c. systems for direct supply of d.c. drives, control circuits and any kind of battery-operated power supply.

DEHNsecure M 1 60 (FM) and DEHNsecure M 2P 60 (FM) are specifically developed for Remote Radio Head (RRH) applications. Designed for possible high load currents, they leave sufficient spare capacity for future extensions in the field of mobile communication.

DEHNsecure M 1 242 (FM) is used for safety lighting systems. The relevant consumers are supplied with a.c. voltage during normal operation and with battery-operated d.c. voltage during emergency operation. As surges may occur during both operating states, DEHNsecure M 1 242 is suited for direct and alternating currents (backup fuse max. 10 A gG).

The modular design of the DEHNsecure arresters makes them safe and user-friendly. Their vibration-proof module locking system, for example, is said to be unique. Shock or vibration during transport or operation or enormous mechanical impulse loads resulting from discharges do not affect the module locking system which ensures safe fixation both for the base part and protection module. Nevertheless, the protection modules can be easily replaced without tools by simply pressing the easy-to-use module release button. The mechanically coded base part and protection module avoid installing an incorrect module. DEHNsecure arresters incorporate double terminals, allowing series connection of the arresters in a space-saving and cost-effective way according to IEC 60364-5-53 requirements for nominal currents up to 125 A.

The operating state/fault indicator of DEHNsecure does not cause operating currents and instantly shows the operating state of the device. Apart from the standard visual indicator with red and green indicator flags, DEHNsecure ... FM devices have an additional remote signalling output. As the remote signalling contact is designed as a floating changeover contact, the remote signal can, depending on the circuit concept, be used as a make or break contact.

DEHNsecure M 1 ...

Coordinated and modular single-pole lightning current arrester for d.c. applications.

Type DSE M ...	1 60	1 220	1 242
Part No.	971 121	971 120	971 122
SPD classification according to EN 61643-11 / IEC 61643-11	type 1 / class I	type 1 / class I	type 1 / class I
Max. continuous operating voltage (d.c.) (U_C)	60 V	220 V	242 V
Lightning impulse current (10/350 μ s) (I_{imp})	25 kA	25 kA	25 kA
Voltage protection level (U_P)	≤ 1.5 kV	≤ 2.5 kV	≤ 2.5 kV
Max. mains-side overcurrent protection	250 A gL	250 A gL	250 A gL
Approvals	UL	—	—
Extended technical data:	when used in safety lighting systems		
– Max. continuous operating voltage (a.c.) (U_C)	—	—	255 V



DEHNsecure M 1 ... FM

Coordinated and modular single-pole lightning current arrester for d.c. applications; with remote signalling contact for monitoring device (floating changeover contact).



Type DSE M ...	1 60 FM	1 220 FM	1 242 FM
Part No.	971 126	971 125	971 127
SPD classification according to EN 61643-11 / IEC 61643-11	type 1 / class I	type 1 / class I	type 1 / class I
Max. continuous operating voltage (d.c.) (U _c)	60 V	220 V	242 V
Lightning impulse current (10/350 μs) (I _{imp})	25 kA	25 kA	25 kA
Voltage protection level (U _p)	≤ 1.5 kV	≤ 2.5 kV	≤ 2.5 kV
Max. mains-side overcurrent protection	250 A gL	250 A gL	250 A gL
Approvals	UL	—	—
Type of remote signalling contact	changeover contact	changeover contact	changeover contact
Extended technical data:	when used in safety lighting systems		
– Max. continuous operating voltage (a.c.) (U _c)	—	—	255 V

DEHNsecure M 2P ... (FM)

Coordinated and modular two-pole lightning current arrester for d.c. applications up to 60 V (1+1 configuration); FM version with floating remote signalling contact.



Type DSE M ...	2P 60	2P 60 FM
Part No.	971 221	971 226
SPD classification according to EN 61643-11 / IEC 61643-11	type 1 / class I	type 1 / class I
Max. continuous operating voltage (d.c.) (U _c)	60 V	60 V
Lightning impulse current (10/350 μs) (DC+/DC- -> DC-/DC+) / (DC-/DC+ -> ≐) (I _{imp})	25 / 50 kA	25 / 50 kA
Voltage protection level (DC+/DC- -> DC-/DC+) / (DC-/DC+ -> ≐) (U _p)	≤ 1.5 / ≤ 1.5 kV	≤ 1.5 / ≤ 1.5 kV
Max. mains-side overcurrent protection	250 A gL	250 A gL
Approvals	UL	UL
Type of remote signalling contact	—	changeover contact



Protection Module for DEHNsecure modular



- Spark gap technology particularly suited for use in d.c. circuits
- Operating state / fault indication by green / red indicator flag in the inspection window
- Easy replacement of protection modules without tools due to module locking system with module release button

DSE MOD ...: Spark-gap-based protection module

Avoid additional, short-notice and unplanned maintenance jobs. In multipole protective circuits, we recommend replacing the complete set of protection modules when one module fails.

For protecting d.c. consumer installations against surges and even direct lightning strikes. For installation in conformity with the lightning protection zone concept at the boundaries from 0_A – 1.

DSE M Spark-Gap-Based Protection Module



Type DSE MOD ...	60	220	242
Part No.	971 001	971 002	971 003
Max. continuous operating voltage (d.c.) (U _c)	60 V	220 V	242 V
Lightning impulse current (10/350 μs) (I _{imp})	25 kA	25 kA	25 kA

DSE PE Spark-Gap-Based Protection Module



Type DSE MOD ...	PE 60
Part No.	971 010
Max. continuous operating voltage (d.c.) (U _c)	60 V
Lightning impulse current (10/350 μs) (I _{imp})	50 kA

DEHNbloc

- Encapsulated non-exhausting creepage discharge spark gap
- RADAX Flow spark gap technology with high follow current limitation
- Energy coordination with other arresters of the Red/Line product family
- Can also be used upstream of meter panels due to its high insulation resistance
- Multifunctional terminal for connecting conductors and busbars
- Single-pole and three-pole version (lightning impulse currents up to 100 kA depending on the system configuration)
- Modular single-pole version also available



For protecting low-voltage consumer installations against surges and even direct lightning strikes. For installation in conformity with the lightning protection zone concept at the boundaries from $0_A - 1$.

DEHNbloc H M 1 255: Modular single-pole lightning current arrester with high follow current limitation

DEHNbloc 1 255 H: Single-pole lightning current arrester with high follow current limitation

DEHNbloc 3 255 H: Three-pole lightning current arrester with high follow current limitation

The spark gaps of the DEHNbloc lightning current arresters allow compact configuration of low-voltage distribution boards. By using pressurised and encapsulated creepage discharge spark gaps, no safety distance from busbars and special flameproof enclosures are necessary.

With a lightning current discharge capacity up to 50 kA (10/350 μ s) per pole, DEHNbloc devices fulfil the highest national and international lightning protection and application standards.

Consistent pursuit of the idea of integration has made the DEHNbloc devices even more efficient: With DEHNbloc H, the groundbreaking RADAX Flow spark gap technology for follow current extinction and limitation was integrated into the DEHNbloc family.

The RADAX flow technology prevents interruptions in operation due to tripping of the circuit breaker when the arrester responds. In times where systems increasingly depend on a properly functioning electrical infrastructure, this is an indispensable product feature. Thanks to the patented RADAX Flow principle, even the amplitude of short-circuit currents in installations up to 50 kA_{rms} can be limited to approx. 500 A and extinguished after approximately 5 ms. This feature ensures selectivity even in case of low-current-rated fuses.

But the DEHNbloc H family concept also stands out due to other product features: With its double terminals on the phase and earth side, the single-pole DEHNbloc 1 255 H device offers various application options.

The DBH M 1 255 device with a new arrester design features the approved module release system that safely fixes the protection module to the base part even at maximum loads on the protection module. The module can be easily replaced without tools by simply pressing the module release button of the protection module.

By using the double terminals suitable for all conductors, even three-pole DEHNbloc 3 255 H arresters can be connected in series in a space-saving and cost-effective way up to nominal currents of 125 A as preferred by IEC 60364-5-53.

If DEHNbloc is to be used with other DIN rail mounted devices, the multifunctional terminals are ideally suited for connecting conductors and busbars.

DEHNbloc H

Modular single-pole lightning current arrester with a high discharge capacity for use in 230/400 V systems.

Type	DBH M 1 255
Part No.	961 122
SPD according to EN 61643-11 / IEC 61643-11	type 1 / class I
Max. continuous operating voltage (a.c.) (U_c)	255 V (50 / 60 Hz)
Lightning impulse current (10/350 μ s) (I_{imp})	50 kA
Voltage protection level (U_p)	≤ 4 kV
Max. backup fuse (L) up to $I_K = 50$ kA _{rms} ($t_a \leq 0.2$ s)	500 A gG
Max. backup fuse (L) up to $I_K = 50$ kA _{rms} ($t_a \leq 5$ s)	315 A gG



Accessories for DEHNbloc

DB H Spark-Gap-Based Protection Module

Type	DBH MOD 255
Part No.	961 022
Max. continuous operating voltage (a.c.) (U_c)	255 V



DEHNbloc 1 255 H

Single-pole (3-0 configuration) lightning current arrester with a high discharge capacity for use in 230/400 V systems.



Type	DB 1 255 H
Part No.	900 222
SPD according to EN 61643-11 / IEC 61643-11	type 1 / class I
Max. continuous operating voltage (a.c.) (U_c)	255 V (50 / 60 Hz)
Lightning impulse current (10/350 μ s) (I_{imp})	50 kA
Voltage protection level (U_p)	≤ 4 kV
Max. backup fuse up to $I_k = 50$ kA _{rms} ($t_a \leq 0.2$ s)	500 A gG
Max. backup fuse up to $I_k = 50$ kA _{rms} ($t_a \leq 5$ s)	315 A gG
Approvals	KEMA

DEHNbloc 3 255 H

Three-pole (3-0 configuration) lightning current arrester with a high discharge capacity for use in 230/400 V systems.



Type	DB 3 255 H
Part No.	900 120
SPD according to EN 61643-11 / IEC 61643-11	type 1 / class I
Max. continuous operating voltage (a.c.) (U_c)	255 V (50 / 60 Hz)
Lightning impulse current (10/350 μ s) [L1+L2+L3-N/PEN] (I_{total})	100 kA
Voltage protection level (U_p)	≤ 4 kV
Max. backup fuse up to $I_k = 50$ kA _{rms} ($t_a \leq 0.2$ s)	500 A gG
Max. backup fuse up to $I_k = 50$ kA _{rms} ($t_a \leq 5$ s)	315 A gG
Approvals	KEMA

DEHNgap

- Discharge capacity up to 100 kA (10/350 μ s)
- Total current arrester specifically designed for installation in 3+1 and 1+1 configurations of TT systems according to IEC 60364-5-53 between neutral conductor N and protective conductor PE
- Creepage discharge spark gap technology
- Operating state / fault indication by green / red indicator flag in the inspection window



For protecting low-voltage consumer's installations against surges and even direct lightning strikes. For installation in conformity with the lightning protection zone concept at the boundaries from $0_A - 1$ (3+1 configuration).

- DEHNgap M 255 (FM):** Coordinated and modular single-pole N-PE lightning current arrester
- DEHNgap Maxi 1 255 S:** Coordinated single-pole N-PE lightning current arrester for busbars
- DEHNgap Maxi 1 255 (FM):** Coordinated single-pole N-PE lightning current arrester for 3+1 configurations with DEHNvenCI
- DEHNgap Maxi 440 (FM):** Coordinated single-pole N-PE lightning current arrester for $U_c = 440$ V a.c.
- DEHNgap H M 255:** Modular single-pole N-PE lightning current arrester

As total current arresters between the neutral and protective conductor in TT systems, the single-pole N-PE lightning current arresters of type DEHNgap M, DEHNgap Maxi, DEHNgap Maxi S and DEHNgap H M have the task of fulfilling the requirements for protecting personnel and equipment in 1+1 or 3+1 configurations. The creepage discharge spark gaps implemented were specifically developed to meet this challenge. With a discharge capacity up to 100 kA (10/350 μ s), they fulfil the highest national and international lightning protection standards. Their leakage-current-free spark gap design allows the devices to be used in areas upstream of the meter panel according to the German VDN guideline.

The DEHNgap M, DEHNgap Maxi S and DEHNgap Maxi coordinated N-PE lightning current arresters have a special status among total current arresters. Due to their low voltage protection level, they can be directly coordinated with N-PE surge arresters of the DEHNgard M family and DEHNgap C S surge arresters without an additional decoupling coil. If lightning current arresters are to be installed along with surge arresters at the same location, no additional DEHNgap C S is required thanks to the low voltage protection level of DEHNgap M and DEHNgap Maxi.

The design and installation of DEHNgap Maxi S arresters are adapted to the unique nature of low-voltage switchgear installations and entirely complement the use of DEHnbloc Maxi S arresters.

The multifunctional terminals of the DIN rail mounted DEHNgap M and DEHNgap H M devices are suitable for connecting conductors and busbars, allowing convenient wiring with other DIN rail mounted terminals.

With its functional Red/Line design, DEHNgap M combines safety and ease of use in a single device. The mechanical operating state / fault indication as well as the unique module locking system stand for fulfilling high safety requirements. The module locking system fixes the protection modules to the base part. Neither vibration during transport nor the enormous forces of discharge can loosen the protection modules. Nevertheless, they can be easily replaced without tools by simply pressing the module release button of the protection module. Each protection module is mechanically coded to avoid installing an incorrect module. Apart from the standard visual indication of DEHNgap M, DEHNgap M ... FM features a three-pole remote signalling terminal. As the remote signalling contact is designed as a floating changeover contact, the remote signal can, depending on the circuit concept, be used as a make or break contact.



DEHNgap M 255 (FM)

Coordinated and modular single-pole N-PE lightning current arrester; FM version with floating remote signalling contact.



Type	DGP M 255	DGP M 255 FM
Part No.	961 101	961 105
SPD according to EN 61643-11 / IEC 61643-11	type 1 / class I	type 1 / class I
Max. continuous operating voltage (a.c.) (U _c)	255 V (50 / 60 Hz)	255 V (50 / 60 Hz)
Lightning impulse current (10/350 μs) (I _{imp})	100 kA	100 kA
Voltage protection level (U _p)	≤ 1.5 kV	≤ 1.5 kV
Approvals	VDE, KEMA, UL	VDE, KEMA, UL
Type of remote signalling contact	—	changeover contact

DEHNgap Maxi 1 255 S

Coordinated single-pole N-PE lightning current arrester for busbars.



Type	DGPM 1 255 S
Part No.	900 050
SPD according to EN 61643-11 / IEC 61643-11	type 1 / class I
Max. continuous operating voltage (a.c.) (U _c)	255 V (50 / 60 Hz)
Lightning impulse current (10/350 μs) (I _{imp})	100 kA
Voltage protection level (U _p)	≤ 2.5 kV (including 80 cm connecting cable)
Operating state monitoring	via DEHNSignal DSI E 3

DEHNgap Maxi 1 255 (FM)

Coordinated single-pole N-PE lightning current arrester; FM version with floating remote signalling contact.



Type	DGPM 1 255	DGPM 1 255 FM
Part No.	961 180	961 185
SPD according to EN 61643-11 / IEC 61643-11	type 1 + type 2 / class I + class II	type 1 + type 2 / class I + class II
Max. continuous operating voltage (a.c.) (U _c)	255 V (50 / 60 Hz)	255 V (50 / 60 Hz)
Lightning impulse current (10/350 μs) (I _{imp})	100 kA	100 kA
Voltage protection level (U _p)	≤ 1.5 kV	≤ 1.5 kV
Type of remote signalling contact	—	changeover contact

DEHNgap Maxi 440 (FM)

Coordinated single-pole N-PE lightning current arrester; FM version with floating remote signalling contact.



Type	DGPM 440	DGPM 440 FM
Part No.	961 160	961 165
SPD according to EN 61643-11 / IEC 61643-11	type 1 / class I	type 1 / class I
Max. continuous operating voltage (a.c.) (U _c)	440 V (50 / 60 Hz)	440 V (50 / 60 Hz)
Lightning impulse current (10/350 μs) (I _{imp})	100 kA	100 kA
Voltage protection level (U _p)	≤ 2.5 kV	≤ 2.5 kV
Approvals	UL	UL
Type of remote signalling contact	—	changeover contact

DEHNgap H M 255

Modular single-pole N-PE lightning current arrester.



Type	DGPH M 255
Part No.	961 102
SPD according to EN 61643-11 / IEC 61643-11	type 1 / class I
Max. continuous operating voltage (a.c.) (U _c)	255 V (50 / 60 Hz)
Lightning impulse current (10/350 μs) (I _{imp})	100 kA
Voltage protection level (U _p)	≤ 4 kV

Protection Module for DEHNgap modular

- High discharge capacity due to powerful creepage discharge spark gap
- Easy replacement of protection modules without tools due to module locking system with module release button
- Operating state / fault indication by green / red indicator flag in the inspection window
- The plug-in protection module can be replaced without the need to de-energise and without removing the distribution board cover



For protecting low-voltage consumer installations against surges and even direct lightning strikes. For installation in conformity with the lightning protection zone concept at the boundaries from 0_A-1 (3+1 configuration).

DGP M MOD 255: 100 kA N-PE spark-gap-based protection module for all devices of the modular DEHNgap M family

DGPH MOD 255: 100 kA N-PE spark-gap-based protection module for all devices of the modular DEHNgap M H family

The N-PE spark-gap-based protection modules of the modular DEHNgap M family combine safety and innovation in a single device. Apart from the powerful encapsulated creepage discharge spark gap, the compact protection modules incorporate a monitoring device and an operating state / fault indicator. The mechanical coding of the protection module prevents

that the N-PE protection modules are confused with the spark-gap-based protection module for the phase conductors. The module locking system safely fixes the protection modules to the base part. The protection modules can be easily removed without tools by simply pressing the release button.

DGP M – 100 kA N-PE Spark-Gap-Based Protection Module

N-PE spark-gap-based protection module for all devices of the modular DEHNgap M family.

Type	DGP M MOD 255
Part No.	961 010
Max. continuous operating voltage (a.c.) (U _c)	255 V
Lightning impulse current (10/350 μs) (I _{imp})	100 kA



DGPH M – 100 kA N-PE Spark-Gap-Based Protection Module

N-PE spark-gap-based protection module for all devices of the modular DEHNgap H M family.



Type	DGPH MOD 255
Part No.	961 020
Max. continuous operating voltage (a.c.) (U _c)	255 V
Lightning impulse current (10/350 μs) (I _{imp})	100 kA



Selection Chart – Industrial Buildings

TN-C system	TN-S system	TT system	230/400 V a.c.	400/690 V a.c.	Higher voltages (a.c.)	Advanced Circuit Interruption	DIIN rail	d.c. applications	PV system	Remote signalling contact (F/M)	Type	Part No.	Page
1 pc			•			•	•			•	DG M TNC ACI 275 FM	952 330	53
	1 pc		•			•	•			•	DG M TNS ACI 275 FM	952 440	53
		1 pc	•			•	•			•	DG M TT ACI 275 FM	952 341	53
1 pc			•				•				DG M TNC 275	952 300	60
1 pc			•				•			•	DG M TNC 275 FM	952 305	61
	1 pc		•				•				DG M TNS 275	952 400	61
	1 pc		•				•			•	DG M TNS 275 FM	952 405	61
		1 pc	•				•				DG M H TT 275	952 381	61
		1 pc	•				•			•	DG M H TT 275 FM	952 385	61
3 pcs	4 pcs	3 pcs	•				•				DG S 275	952 070	65
		1 pc	•				•				DGP C S	952 030	81
3 pcs	4 pcs	3 pcs	•				•			•	DG S CI 275 FM	952 099	57
3 pcs	4 pcs	3 pcs	•				•			•	DG S 275 FM	952 090	66
		1 pc	•				•			•	DGP C S FM	952 035	81
1 pc				•			•				DG M TNC 440	952 303	60
1 pc				•			•			•	DG M TNC 440 FM	952 308	61
1 pc				•			•			•	DG SE CI 440 FM	952 920	59
1 pc				•			•			•	DG SE CI WE 440 FM	952 923	59
3 pcs	4 pcs				•		•				DG S WE 600	952 077	66
3 pcs	4 pcs				•		•			•	DG S WE 600 FM	952 097	66
1 pc					•		•				DG M WE 600	952 302	63
1 pc					•		•			•	DG M WE 600 FM	952 307	63
3 pcs	4 pcs				•		•			•	DG SE H 1000 FM	952 938	68
3 pcs	4 pcs				•		•			•	DG SE H 1000 VA FM	952 940	69
							•	•			DG SE DC 242	972 120	83
							•	•		•	DG SE DC 242 FM	972 125	83
							•		•	•	DG M YPV 1200 FM	952 565	84
							•		•		DCU YPV SCI 1000 1M	900 910	91

Selection Chart – Functional Buildings

TN-C system	TN-S system	TT system	Advanced Circuit Interruption 	DIN rail	Single-phase application	d.c. application 	PV system	Remote signalling contact (FM)	Type	Part No.	Page
1 pc			●	●				●	DG M TNC ACI 275 FM	952 330	53
	1 pc		●	●				●	DG M TNS ACI 275 FM	952 440	53
		1 pc	●	●				●	DG M TT ACI 275 FM	952 341	53
3 pcs	4 pcs	3 pcs 1 pc ↙	●	●				●	DG S CI 275 FM	952 099	57
				●				●	DGP C S FM	952 035	81
1 pc				●					DG M TNC 275	952 300	60
1 pc				●				●	DG M TNC 275 FM	952 305	61
	1 pc			●					DG M TNS 275	952 400	61
	1 pc			●				●	DG M TNS 275 FM	952 405	61
		1 pc		●				●	DG M H TT 275	952 381	61
		1 pc		●				●	DG M H TT 275 FM	952 385	61
3 pcs	4 pcs	3 pcs 1 pc ↙		●					DG S 275	952 070	65
				●					DGP C S	952 030	81
3 pcs	4 pcs	3 pcs		●				●	DG S 275 FM	952 090	66
					●				DCOR L 3P 275 SO LTG	900 445	79
					●				DCOR L 3P 275 SO IP	900 447	80
				●		●			DG SE DC 242	972 120	83
				●		●		●	DG SE DC 242 FM	972 125	83
				●			●	●	DG M YPV 1200 FM	952 565	84

Selection Chart – Single-family Houses

TN-C system	TN-S system	TT system	DIN rail	PV system	Remote signalling contact (FM)	Type	Part No.	Page
1 pc			●			DG M TNC 275	952 300	60
1 pc			●		●	DG M TNC 275 FM	952 305	61
	1 pc		●			DG M TNS 275	952 400	61
	1 pc		●		●	DG M TNS 275 FM	952 405	61
		1 pc	●			DG M TT 275	952 310	61
		1 pc	●		●	DG M TT 275 FM	952 315	62
		1 pc	●		●	DG M H TT 275	952 381	61
		1 pc	●		●	DG M H TT 275 FM	952 385	61
3 pcs	4 pcs	3 pcs 1 pc ↙	●			DG S 275	952 070	65
			●			DGP C S	952 030	81
3 pcs	4 pcs	3 pcs 1 pc ↙	●		●	DG S 275 FM	952 090	66
			●		●	DGP C S FM	952 035	81
				●		DCU YPV SCI 1000 1M	900 910	91
			●	●	●	DG M YPV 1200 FM	952 565	84
			●		●	DEHncord 3P TT 275 FM	900 439	78

DEHNguard modular with Advanced Circuit Interruption (Safe Dimensioning)

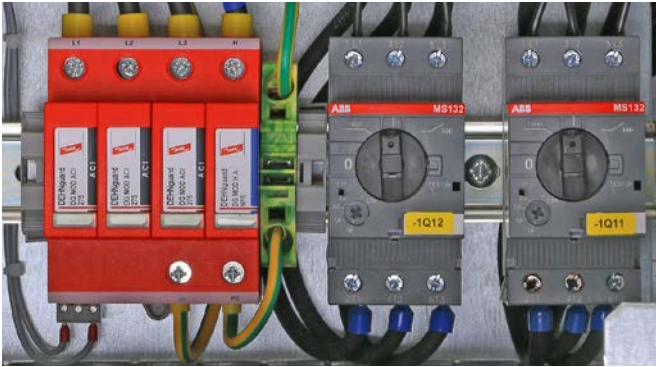

For protecting low-voltage consumer installations against surges. For installation in conformity with the lightning protection zone concept at the boundaries from $O_B - 1$ and higher.

- New technology “Advanced Circuit Interruption” (ACI) integrated in the protection module, consists of a switch / spark gap combination
- Due to ACI technology no external backup fuse required
- Small connection cross-sections (6 mm² Cu) absolutely sufficient *)
- TOV withstand also at 440 V (AC)
- High system reliability, no tripping of 32 A gG fuses
- Zero leakage current due to galvanic isolation by ACI switch unit
- Energy coordination with other arresters of the Red/Line product family

NEW

*) All live conductors should be wired so that they are inherently short-circuit and earth fault proof

- DEHNguard M TNC ACI 275 FM: Modular surge arrester with integrated ACI technology for TN-C systems
- DEHNguard M TNS ACI 275 FM: With integrated ACI technology for TN-S systems
- DEHNguard M TT ACI ... FM: With integrated ACI technology for TT and TN-S systems (3+1 configuration)
- DEHNguard M TN ACI 275 FM: With integrated ACI technology for 230 V TN systems
- DEHNguard M TT 2P ACI ... FM: With integrated ACI technology for 230 V TT and TN systems (1+1 configuration)
- DEHNguard S ACI ... FM: Modular single-pole surge arrester with integrated ACI technology
- DEHNguard M/S ... ACI ... FM: With remote signalling contact for monitoring device (floating changeover contact)

The new modular surge arrester of the DEHNguard ACI product family provides safety at the highest level. This is thanks to ACI technology (Advanced Circuit Interruption) which replaces the backup fuse with a switch/spark-gap combination connected in series with a high capacity varistor.

At the end of the service life of the ACI surge arrester, the new technology reduces any fault current to such an extent that not even the smallest fuses in the system are tripped. This means much greater availability and operational safety for the system in comparison with standard type 2 arresters with external fuses.

The new internal arrester backup fuse has further advantages:

Safe dimensioning: Eliminate mistakes

The new technology prevents design errors which might occur when dimensioning or selecting overload protection; thus eliminating the need for a backup fuse. With ACI, protection is directly integrated in the arrester and, as a result, optimally adjusted to it. DEHNguard ACI automatically eliminates the possibility of faulty installation or dimensioning errors. The arrester also leaves more space in the switchgear cabinet as there is no need for an additional upstream backup fuse. In addition to the condition of the varistor, that of the switch/spark-gap combination is also signalled and notified via the tried and tested mechanical operating state / fault indicator.

Conductor cross-section of only 6 mm²: Easier to install

A conductor cross-section of 6 mm² is always enough for the active conductors and PE. You save the valuable time you would, in the past, have spent dimensioning the cross-sections. 6 mm² Cu also makes installation easier because the bending radiuses are smaller. DEHNguard ACI therefore allows shorter wiring.

TOV withstand: Increase availability

Temporary overvoltages (e.g. caused by loss of neutral) can destroy conventional surge protective devices. The new DEHNguard ACI has a much better TOV withstand and provides protection without device failure even at 440 V (AC). This increases the availability of your system and avoids wasting time and money on troubleshooting and repairing unnecessary damage.

Zero leakage current: Increase service lifetime

Due to the construction of DEHNguard ACI there is no leakage current. This prevents premature ageing of the protective device so that no time and money is wasted on replacement. DEHNguard ACI arresters also contribute towards operational safety because they prevent the accidental tripping of the insulation monitoring.

Transition in the energy sector: Fulfil future requirements

With ACI arresters you are safely equipped for the future – even if network parameters change, e.g. as a result of renewable power generation. Isolated grids and storage systems change the short-circuiting conditions.

DEHNguard ACI – Maximum system availability

System downtimes caused by an upstream safety device tripping or being switched back on are a thing of the past. This means much greater availability and operational safety for the system in comparison with standard type 2 arresters with external fuses.

Surge Arresters – Type 2

DEHGuard M TNC ACI 275 FM

Modular surge arrester with Advanced Circuit Interruption (ACI) for TN-C systems.

Type DG ...	M TNC ACI 275 FM
Part No.	952 330 <small>NEW!</small>
SPD according to EN 61643-11 / IEC 61643-11	type 2 / class II
Max. continuous operating voltage (a.c.) (U _c)	275 V (50 / 60 Hz)
Nominal discharge current (8/20 μs) (I _n)	20 kA
Voltage protection level (U _p)	≤ 1.5 kV
Additional external fuse	not required
Temporary overvoltage (TOV) (U _T) – Characteristic	440 V / 120 min. – withstand
Approvals	KEMA



DEHGuard M TNS ACI 275 FM

Modular surge arrester with Advanced Circuit Interruption (ACI) for TN-S systems.

Type DG ...	M TNS ACI 275 FM
Part No.	952 440 <small>NEW!</small>
SPD according to EN 61643-11 / IEC 61643-11	type 2 / class II
Max. continuous operating voltage AC [L-PE] (U _c)	275 V (50 / 60 Hz)
Nominal discharge current (8/20 μs) (I _n)	20 kA
Voltage protection level [L-PE] / [N-PE] (U _p)	≤ 1.5 / ≤ 1.5 kV
Additional external fuse	not required
Temporary overvoltage (TOV) (U _T) – Characteristic	440 V / 120 min. – withstand
Approvals	KEMA



DEHGuard M TT ACI ... FM

Modular surge arrester with Advanced Circuit Interruption (ACI) for TT and TN-S systems (3+1 configuration).

Type DG ...	M TT ACI 275 FM	M TT ACI 385 FM
Part No.	952 341 <small>NEW!</small>	952 342 <small>NEW!</small>
SPD according to EN 61643-11 / IEC 61643-11	type 2 / class II	type 2 / class II
Max. continuous operating voltage (a.c.) [L-N] (U _c)	275 V (50 / 60 Hz)	385 V (50 / 60 Hz)
Nominal discharge current (8/20 μs) [L-N] (I _n)	20 kA	20 kA
Voltage protection level [L-N] / [N-PE] (U _p)	≤ 1.5 / ≤ 1.5 kV	≤ 1.5 / ≤ 1.5 kV
Additional external fuse	not required	not required
Temporary overvoltage (TOV) [L-N] (U _T) – Characteristic	440 V / 120 min. – withstand	440 V / 120 min. – withstand
Temporary overvoltage (TOV) [N-PE] (U _T) – Characteristic	1200 V / 200 ms – withstand	1200 V / 200 ms – withstand
Approvals	KEMA	KEMA



DEHGuard M TN ACI 275 FM

Modular surge arrester with Advanced Circuit Interruption (ACI) for single-phase 230 V-TN systems.

Type DG ...	M TN ACI 275 FM
Part No.	952 220 <small>NEW!</small>
SPD according to EN 61643-11 / IEC 61643-11	type 2 / class II
Max. continuous operating voltage AC [L-PE] (U _c)	275 V (50 / 60 Hz)
Nominal discharge current (8/20 μs) (I _n)	20 kA
Voltage protection level [L-PE] / [N-PE] (U _p)	≤ 1.5 / ≤ 1.5 kV
Additional external fuse	not required
Temporary overvoltage (TOV) (U _T) – Characteristic	440 V / 120 min. – withstand
Approvals	KEMA



DEHNgard M TT 2P ACI ... FM

Modular surge arrester with Advanced Circuit Interruption (ACI) for single-phase 230 V-TT and TN systems (1+1 configuration).

NEW



Type DG ...	M TT 2P ACI 275 FM	M TT 2P ACI 385 FM
Part No.	952 121 ^{NEW}	952 122 ^{NEW}
SPD according to EN 61643-11 / IEC 61643-11	type 2 / class II	type 2 / class II
Max. continuous operating voltage (a.c.) [L-N] (U _c)	275 V (50 / 60 Hz)	385 V (50 / 60 Hz)
Nominal discharge current (8/20 μs) [L-N] (I _n)	20 kA	20 kA
Voltage protection level [L-N] / [N-PE] (U _p)	≤ 1.5 / ≤ 1.5 kV	≤ 1.5 / ≤ 1.5 kV
Additional external fuse	not required	not required
Temporary overvoltage (TOV) [L-N] (U _T) – Characteristic	440 V / 120 min. – withstand	440 V / 120 min. – withstand
Temporary overvoltage (TOV) [N-PE] (U _T) – Characteristic	1200 V / 200 ms – withstand	1200 V / 200 ms – withstand
Approvals	KEMA	KEMA

DEHNgard S ACI ... FM

Pluggable single-pole surge arrester consisting of a base part and plug-in protection module; with Advanced Circuit Interruption (ACI).

NEW



Type DG ...	S ACI 275 FM	S ACI 385 FM
Part No.	952 100 ^{NEW}	952 113 ^{NEW}
SPD according to EN 61643-11 / IEC 61643-11	type 2 / class II	type 2 / class II
Max. continuous operating voltage (a.c.) (U _c)	275 V (50 / 60 Hz)	385 V (50 / 60 Hz)
Nominal discharge current (8/20 μs) (I _n)	20 kA	20 kA
Voltage protection level (U _p)	≤ 1.5 kV	≤ 1.5 kV
Additional external fuse	not required	not required
Temporary overvoltage (TOV) (U _T) – Characteristic	440 V / 120 min. – withstand	440 V / 120 min. – withstand
Approvals	KEMA	KEMA

Accessories for DEHNgard modular with Advanced Circuit Interruption (safe dimensioning)

NEW



Switch / Spark Gap Protection Module for DEHNgard ACI

Type	DG MOD ACI 275	DG MOD ACI 385
Part No.	952 024 ^{NEW}	952 028 ^{NEW}
Max. continuous operating voltage (a.c.) (U _c)	275 V	385 V

NEW



Spark-gap Based Protection Module for DEHNgard M ACI

Type	DG MOD A NPE
Part No.	952 022 ^{NEW}
Max. continuous operating voltage (a.c.) (U _c)	275 V

NEW



N-PE Spark-Gap-Based Protection Module for DEHNgard M ACI

Type	DG MOD H A NPE
Part No.	952 083 ^{NEW}
Max. continuous operating voltage (a.c.) (U _c)	275 V

DEHNGuard modular with Integrated Backup Fuse

- Arrester backup fuse integrated in the protection module
- Prewired complete unit consisting of a base part and plug-in protection modules
- Energy coordination with other arresters of the Red/Line product family
- High discharge capacity
- High reliability due to "Thermo Dynamic Control" SPD monitoring device
- Easy replacement of protection modules without tools due to module locking system with module release button



For protecting low-voltage consumer installations against surges. For installation in conformity with the lightning protection zone concept at the boundaries from $O_B - 1$ and higher.

- DEHNGuard M TNC CI 275:** Modular surge arrester with integrated backup fuse for TN-C systems
- DEHNGuard M TNS CI 275:** With integrated backup fuse for TN-S systems
- DEHNGuard M TT CI 275:** With integrated backup fuse for TT and TN-S systems (3+1 configuration)
- DEHNGuard M TN CI 275:** With integrated backup fuse for 230 V TN systems
- DEHNGuard M TT 2P CI 275:** With integrated backup fuse for 230 V TT and TN systems (1+1 configuration)
- DEHNGuard S CI 275:** Modular single-pole surge arrester with integrated backup fuse
- DEHNGuard M ... CI 275 FM:** With remote signalling contact for monitoring device (floating changeover contact)

The modular surge arresters of the DEHNGuard ... CI family in the functional Red/Line family design represents a perfect symbiosis of short-circuit protection and protection against surges in a protection module that is only one module wide. This sets new standards in terms of user-friendliness with regard to surge protection and safe short-circuiting behaviour.

The protective circuit with the arrester backup fuse integrated in the protection module and the heavy-duty zinc oxide varistor in combination with the dual-action monitoring device "Thermo Dynamic Control" offers far-reaching advantages in terms of simple installation and minimum space requirements.

With the already integrated arrester backup fuse, the user no longer has to worry about arrester-specific dimensioning requirements such as backup protection in the event of a short-circuit and impulse current carrying capability. The integrated fuse has been developed especially for this case of application. It is not designed for continuous current, but rather for impulse current and short-circuit protection which ensures optimal performance. The fuse can only be tripped at the end of the SPD's service life so that separate replacement is never necessary.

Space-saving surge protection measures covering all functions specified in the installation standards can be implemented in installations with short-circuit currents up to 25 kArms. All paths including the N-PE path feature an operating state indicator as required by the IEC 60364-5-53 standard.

Due to the "Thermo Dynamic Control" monitoring device, the surface temperature of the heavy-duty varistor and the intensity of the discharge current are used for evaluation. The operating state of each protective path is shown by means of a mechanical indicator with green and red

indicator flags which does not cause operating currents. It also indicates the activation of the "Thermo Dynamic Control" monitoring device and the integrated arrester backup fuse.

In addition to this mechanical operating state / fault indication, the ... FM version of the DEHNGuard ... CI devices features a three-pole remote signalling terminal. As the remote signalling contact is designed as a floating changeover contact, the remote signal can, depending on the circuit concept, be used as a make or break contact.

All the benefits of the modular design of the DEHNGuard family have been integrated into the new DEHNGuard ... CI family.

The system-configuration-specific product designation and the "Thermo Dynamic Control" monitoring device reflect the high safety requirements.

The unique module locking system prevents the protection modules from working loose due to vibrations during transport or the enormous forces of discharge. Nevertheless, the protection modules can be easily replaced without tools or the need to de-energise or remove the distribution board cover simply by pressing the module release button of the protection modules. Each protective circuit in the multipole and single-pole arresters and each protection module is mechanically coded to avoid installing an incorrect protection module.

The surge arresters of the modular DEHNGuard ... CI family feature multi-functional terminals on a standardised spacing of one module for connecting conductors and busbars, allowing easy wiring with other DIN rail mounted devices. Thus, a variety of applications can be easily connected in series in accordance with IEC 60364-5-53 for optimal protection.

DEHNgard M TNC CI ... (FM)

Modular surge arrester with integrated backup fuses for TN-C systems with a nominal voltage of 230/400 V (3+0 configuration); FM version with floating remote signalling contact.



Type DG ...	M TNC CI 275	M TNC CI 275 FM
Part No.	952 304	952 309
SPD according to EN 61643-11 / IEC 61643-11	type 2 / class II	type 2 / class II
Max. continuous operating voltage (a.c.) (U _c)	275 V (50 / 60 Hz)	275 V (50 / 60 Hz)
Nominal discharge current (8/20 μs) (I _n)	12.5 kA	12.5 kA
Max. discharge current (8/20 μs) (I _{max})	25 kA	25 kA
Voltage protection level (U _p)	≤ 1.5 kV	≤ 1.5 kV
Max. mains-side overcurrent protection	not required	not required
Approvals	KEMA, VDE	KEMA, VDE
Type of remote signalling contact	—	changeover contact

DEHNgard M TNS CI ... (FM)

Modular surge arrester with integrated backup fuses for TN-S systems with a nominal voltage of 230/400 V (4+0 configuration); FM version with floating remote signalling contact.



Type DG ...	M TNS CI 275	M TNS CI 275 FM
Part No.	952 401	952 406
SPD according to EN 61643-11 / IEC 61643-11	type 2 / class II	type 2 / class II
Max. continuous operating voltage (a.c.) (U _c)	275 V (50 / 60 Hz)	275 V (50 / 60 Hz)
Nominal discharge current (8/20 μs) (I _n)	12.5 kA	12.5 kA
Max. discharge current (8/20 μs) (I _{max})	25 kA	25 kA
Voltage protection level [L-PE] / [N-PE] (U _p)	≤ 1.5 / ≤ 1.5 kV	≤ 1.5 / ≤ 1.5 kV
Max. mains-side overcurrent protection	not required	not required
Approvals	KEMA, VDE	KEMA, VDE
Type of remote signalling contact	—	changeover contact

DEHNgard M TT CI ... (FM)

Modular surge arrester with integrated backup fuses for TT and TN-S systems with a nominal voltage of 230/400 V (3+1 configuration); FM version with floating remote signalling contact.



Type DG ...	M TT CI 275	M TT CI 275 FM
Part No.	952 322	952 327
SPD according to EN 61643-11 / IEC 61643-11	type 2 / class II	type 2 / class II
Max. continuous operating voltage (a.c.) [L-N] (U _c)	275 V (50 / 60 Hz)	275 V (50 / 60 Hz)
Nominal discharge current (8/20 μs) [L-N] (I _n)	12.5 kA	12.5 kA
Max. discharge current (8/20 μs) [L-N] (I _{max})	25 kA	25 kA
Voltage protection level [L-N] / [N-PE] (U _p)	≤ 1.5 / ≤ 1.5 kV	≤ 1.5 / ≤ 1.5 kV
Max. mains-side overcurrent protection	not required	not required
Approvals	KEMA, VDE	KEMA, VDE
Type of remote signalling contact	—	changeover contact

DEHNgard M TN CI ... (FM)

Modular surge arrester with integrated backup fuses for single-phase 230 V TN systems (2+0 configuration); FM version with floating remote signalling contact.





Type DG ...	M TN CI 275	M TN CI 275 FM
Part No.	952 173	952 178
SPD according to EN 61643-11 / IEC 61643-11	type 2 / class II	type 2 / class II
Max. continuous operating voltage (a.c.) (U _c)	275 V (50 / 60 Hz)	275 V (50 / 60 Hz)
Nominal discharge current (8/20 μs) (I _n)	12.5 kA	12.5 kA
Max. discharge current (8/20 μs) (I _{max})	25 kA	25 kA
Voltage protection level [L-PE] / [N-PE] (U _p)	≤ 1.5 / ≤ 1.5 kV	≤ 1.5 / ≤ 1.5 kV
Max. mains-side overcurrent protection	not required	not required
Approvals	KEMA, VDE	KEMA, VDE
Type of remote signalling contact	—	changeover contact

Surge Arresters – Type 2

DEHNgard M TT 2P CI ... (FM)



Modular surge arrester with integrated backup fuses for single-phase 230 V TT and TN systems (1+1 configuration); FM version with floating remote signalling contact.

Type DG ...	M TT 2P CI 275	M TT 2P CI 275 FM
Part No.	952 171 	952 176 
SPD according to EN 61643-11 / IEC 61643-11	type 2 / class II	type 2 / class II
Max. continuous operating voltage (a.c.) [L-N] (U_c)	275 V (50 / 60 Hz)	275 V (50 / 60 Hz)
Nominal discharge current (8/20 μ s) [L-N] (I_n)	12.5 kA	12.5 kA
Max. discharge current (8/20 μ s) [L-N] (I_{max})	25 kA	25 kA
Voltage protection level [L-N] / [N-PE] (U_p)	$\leq 1.5 / \leq 1.5$ kV	$\leq 1.5 / \leq 1.5$ kV
Max. mains-side overcurrent protection	not required	not required
Approvals	KEMA, VDE	KEMA, VDE
Type of remote signalling contact	—	changeover contact



DEHNgard S CI ... (FM)

Pluggable single-pole surge arrester consisting of a base part and plug-in protection module; with integrated backup fuse; FM version with floating remote signalling contact.

Type DG ...	S CI 275	S CI 275 FM
Part No.	952 079 	952 099 
SPD according to EN 61643-11 / IEC 61643-11	type 2 / class II	type 2 / class II
Max. continuous operating voltage (a.c.) (U_c)	275 V (50 / 60 Hz)	275 V (50 / 60 Hz)
Nominal discharge current (8/20 μ s) (I_n)	12.5 kA	12.5 kA
Max. discharge current (8/20 μ s) (I_{max})	25 kA	25 kA
Voltage protection level (U_p)	≤ 1.5 kV	≤ 1.5 kV
Max. mains-side overcurrent protection	not required	not required
Approvals	KEMA, VDE	KEMA, VDE
Type of remote signalling contact	—	changeover contact



Accessories for DEHNgard modular with integrated Backup Fuse

Varistor-Based Protection Module for DEHNgard M CI

Protection module for DEHNgard M ... CI 275 surge arresters comprising a varistor connected in series with the integrated backup fuse.

Type	DG MOD CI 275
Part No.	952 020 
Max. continuous operating voltage (a.c.) (U_c)	275 V



N-PE Spark-Gap-Based Protection Module for DEHNgard M TT ...

N-PE spark-gap-based protection module for two-pole and four-pole DEHNgard DG M TT ... surge arresters.

Type	DG MOD NPE
Part No.	952 050
Max. continuous operating voltage (a.c.) (U_c)	255 V



DEHNguard SE CI with Integrated Backup Fuse

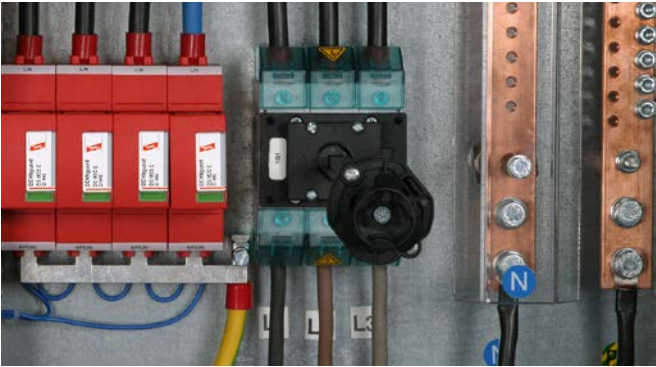

For protecting low-voltage consumer installations against surges. For installation in conformity with the lightning protection zone concept at the boundaries from $O_B - 1$ and higher.

- Arrester backup fuse integrated in the protection module
- For use in case of higher rated voltages
- Energy coordination with other arresters of the Red/Line product family
- High discharge capacity
- High reliability due to "Thermo Dynamic Control" SPD device monitoring
- Easy replacement of protection modules without tools due to module locking system with module release button

DEHNguard SE CI 440 FM: Modular single-pole surge arrester with integrated backup fuse (floating changeover contact)

DEHNguard SE CI WE 440 FM: Modular single-pole surge arrester with integrated backup fuse particularly for use in wind turbines (floating changeover contact)

The modular surge arrester of the DEHNguard SE CI product family for systems with higher rated voltages of 400/690 V is available as type DG SE CI 440 FM and DG SE CI WE 440 FM. Type WE is equipped with a varistor of 750 V rated voltage and therefore perfectly suited for converter operation with voltage peaks, for example in wind turbines.

With the already integrated arrester backup fuse, the user no longer has to worry about arrester-specific dimensioning requirements such as backup protection in the event of a short-circuit or impulse current carrying capability.

Highest system availability is even ensured in case of higher voltages due to the ideal matching of SPD and integrated backup fuse. The integrated fuse has been specially developed for this application. It is not designed for continuous current, but specifically for impulse current and short-circuit protection which ensures optimal performance. The fuse can only be tripped at the end of the SPD's service life so that separate replacement is never necessary.

Due to the "Thermo Dynamic Control" monitoring device, the surface temperature of the heavy-duty varistor and the intensity of the discharge current are used for evaluation. The operating state of each protective

path is shown by means of a mechanical indicator with green and red indicator flags which does not cause operating currents. It also indicates the activation of the "Thermo Dynamic-Control" monitoring device and of the integrated arrester backup fuse.

In addition to this mechanical operating state / fault indication the versions of the DEHNguard SE CI (WE) 440 FM devices feature a three-pole remote signalling terminal. As the remote signalling contact is designed as a floating changeover contact, the remote signal can, depending on the circuit concept, be used as a make or break contact.

All benefits of the modular design of the DEHNguard family have been integrated into the new DEHNguard SE CI family.

The unique module locking system prevents the protection modules from working loose due to vibrations during transport or the enormous forces of discharge.

The pluggable protection modules are mechanically coded which is an additional safety feature of these DEHN devices and guard against installing an incorrect protection module.

Surge Arresters – Type 2

DEHNgard SE CI 440 FM

Pluggable single-pole surge arrester comprising a base part and a plug-in protection module; with integrated backup fuse and remote signalling contact for monitoring unit (floating changeover contact).

Type DG SE CI ...	440 FM
Part No.	952 920
SPD according to EN 61643-11 / IEC 61643-11	type 2 / class II
Max. continuous operating voltage (a.c.) (U_c)	440 V (50 / 60 Hz)
Nominal discharge current (8/20 μ s) (I_n)	12.5 kA
Voltage protection level (U_p)	≤ 2 kV
Max. mains-side overcurrent protection	not required
Type of remote signalling contact	changeover contact



DEHNgard SE CI WE 440 FM

Pluggable single-pole surge arrester with a rated varistor voltage $U_{mov} = 750$ V a.c.; comprising a base part and a plug-in protection module; with integrated backup fuse and remote signalling contact for monitoring unit (floating changeover contact).

Type DG SE CI ...	WE 440 FM
Part No.	952 923
SPD according to EN 61643-11 / IEC 61643-11	type 2 / class II
Max. continuous operating voltage (a.c.) (U_c)	440 V (50 / 60 Hz)
Rated varistor voltage (a.c.) (U_{mov})	750 V
Nominal discharge current (8/20 μ s) (I_n)	12.5 kA
Voltage protection level (U_p)	≤ 3 kV
Max. mains-side overcurrent protection	not required
Type of remote signalling contact	changeover contact



Accessories for DEHNgard SE CI with integrated Backup Fuse

Varistor-based Protection Module for DEHNgard SE CI (WE)

Type	DG MOD E CI 440	DG MOD E CI WE 440
Part No.	952 926	952 927
Max. continuous operating voltage (d.c.) (U_c)	440 V	440 V
Rated varistor voltage (a.c.) (U_{mov})	440 V	750 V





DEHNgard modular

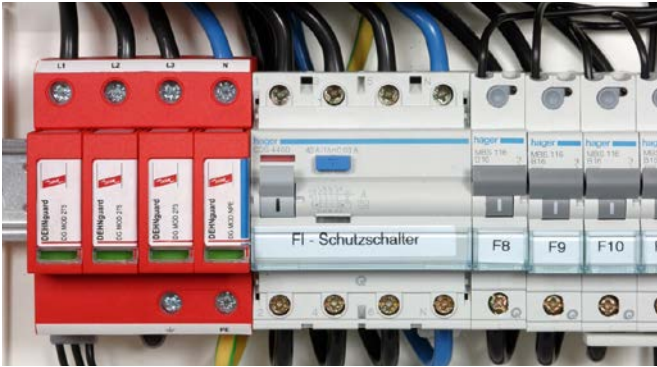

For protecting low-voltage consumer installations against surges. For installation in conformity with the lightning protection zone concept at the boundaries from $O_B - 1$ and higher.

- Prewired complete unit consisting of a base part and plug-in protection modules
- Energy coordination with other arresters of the Red/Line product family
- High discharge capacity due to heavy-duty zinc oxide varistors / spark gaps
- High reliability due to "Thermo Dynamic Control" SPD monitoring device
- Easy replacement of protection modules without tools due to module locking system with module release button
- Vibration and shock-tested according to EN 60068-2

- DEHNgard M TNC ...: Modular surge arrester for use in TN-C systems
 DEHNgard M TNS ...: Modular surge arrester for use in TN-S systems
 DEHNgard M H TT ...: Modular surge arrester with an increased discharge capacity for use in TT and TN-S systems (3+1 configuration)
 DEHNgard M TT ...: Modular surge arrester for use in TT and TN-S systems (3+1 configuration)
 DEHNgard M TN ...: Modular surge arrester for use in single-phase TN systems
 DEHNgard M H TT 2P ...: Modular surge arrester with an increased discharge capacity for single-phase TT and TN systems (1+1 configuration)
 DEHNgard M TT 2P ...: Modular surge arrester for use in single-phase TT and TN systems (1+1 configuration)
 DEHNgard M WE ...: Modular surge arrester especially for use in wind turbines
 DEHNgard M ... FM: With remote signalling contact for monitoring device (floating changeover contact)

Featuring the functional Red/Line family design, the modular DEHNgard M ... surge arresters set new standards in terms of safety and ease of use. The proven protective circuit with heavy-duty zinc oxide varistors in combination with the dual "Thermo Dynamic Control" monitoring device are characteristic of the DEHNgard technology.

A variety of features show that both reliable surge protection and equipment safety are key elements of the modular DEHNgard surge arresters. The application-based product designation, which makes it considerably easier to choose the correct device for the relevant application and the unique module locking system both reflect the most stringent safety requirements. The module locking system firmly fixes the protection modules to the base part. Neither vibration during transport nor the enormous forces of discharge can loosen the protection modules. Nevertheless, they can be easily replaced without tools by simply pressing the easy-to-use module release button of the protection modules. Each protective circuit of the multipole surge arresters and each protection module are mechanically coded to guard against installing an incorrect module.

The dual "Thermo Dynamic Control" monitoring device was not only developed on the basis of national and international product standards, but also reflects decades of experience in the world market of surge protective devices and considers many practical applications where arresters might be damaged. As with all DEHN surge arresters with "Thermo Dynamic Control", the surface temperature of the heavy-duty varistor and the intensity of the discharge current are used for evaluation. The visual indicator with green and red indicator flags shows the availability of every protective circuit. Apart from this standard visual indication, DEHNgard M ... FM devices feature a three-pole remote signalling terminal.

As the remote signalling contact is designed as a floating changeover contact, the remote signal can, depending on the circuit concept, be used as a make or break contact. The surge arresters of the modular multipole DEHNgard M family feature multifunctional terminals on a standardised spacing of 1 module for the connection of conductors and busbars, allowing easy wiring with other DIN rail mounted devices. The STAK 25 pin-shaped terminal, which is compatible with all DEHNgard modules, allows optimal series connection according to IEC 60364-5-53.

The DEHNgard M H TT ... type already meets the requirements of the new VDE 0100-534 standard (Table: Discharge values I_n in a 3+1 configuration for three-phase systems with increased safety requirements). This standard requires at least 40 kA for the N-PE path. Since it was technically possible to implement a discharge capacity of 80 kA here, even an arithmetically correct design ($4 \times 20 \text{ kA} = 80 \text{ kA}$) in combination with standard varistor modules with $I_n = 20 \text{ kA}$ was implemented.

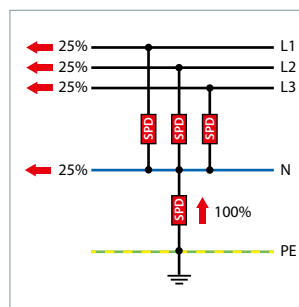

3+1 configuration with an increased discharge capacity $4 \times 20 \text{ kA} = 80 \text{ kA}$.

DEHNgard M TNC ...

Modular surge arrester for use in TN-C systems (3+0 configuration).

Type DG M ...	TNC 150	TNC 275	TNC 385	TNC 440
Part No.	952 313	952 300	952 314	952 303
SPD according to EN 61643-11 / IEC 61643-11	type 2 / class II	type 2 / class II	type 2 / class II	type 2 / class II
Max. continuous operating voltage (a.c.) (U_C)	150 V (50 / 60 Hz)	275 V (50 / 60 Hz)	385 V (50 / 60 Hz)	440 V (50 / 60 Hz)
Nominal discharge current (8/20 μ s) (I_n)	15 kA	20 kA	20 kA	20 kA
Max. discharge current (8/20 μ s) (I_{max})	40 kA	40 kA	40 kA	40 kA
Voltage protection level (U_p)	$\leq 0.7 \text{ kV}$	$\leq 1.5 \text{ kV}$	$\leq 1.75 \text{ kV}$	$\leq 2 \text{ kV}$
Max. mains-side overcurrent protection	125 A gG	125 A gG	125 A gG	125 A gG
Approvals	KEMA, UL	KEMA, VDE, UL	KEMA, UL	KEMA, UL



DEHGuard M TNC ... FM

Modular surge arrester for use in TN-C systems (3+0 configuration); with floating changeover contact.

Type DG M ...	TNC 150 FM	TNC 275 FM	TNC 385 FM	TNC 440 FM
Part No.	952 318	952 305	952 319	952 308
SPD according to EN 61643-11 / IEC 61643-11	type 2 / class II	type 2 / class II	type 2 / class II	type 2 / class II
Max. continuous operating voltage (a.c.) (U_c)	150 V (50 / 60 Hz)	275 V (50 / 60 Hz)	385 V (50 / 60 Hz)	440 V (50 / 60 Hz)
Nominal discharge current (8/20 μ s) (I_n)	15 kA	20 kA	20 kA	20 kA
Max. discharge current (8/20 μ s) (I_{max})	40 kA	40 kA	40 kA	40 kA
Voltage protection level (U_p)	≤ 0.7 kV	≤ 1.5 kV	≤ 1.75 kV	≤ 2 kV
Max. mains-side overcurrent protection	125 A gG	125 A gG	125 A gG	125 A gG
Approvals	KEMA, UL	KEMA, VDE, UL	KEMA, UL	KEMA, UL
Type of remote signalling contact	changeover contact	changeover contact	changeover contact	changeover contact



DEHGuard M TNS ...

Modular surge arrester for use in TN-S systems (4+0 configuration).

Type DG M ...	TNS 150	TNS 275	TNS 385
Part No.	952 403	952 400	952 404
SPD according to EN 61643-11 / IEC 61643-11	type 2 / class II	type 2 / class II	type 2 / class II
Max. continuous operating voltage (a.c.) (U_c)	150 V (50 / 60 Hz)	275 V (50 / 60 Hz)	385 V (50 / 60 Hz)
Nominal discharge current (8/20 μ s) (I_n)	15 kA	20 kA	20 kA
Max. discharge current (8/20 μ s) (I_{max})	40 kA	40 kA	40 kA
Voltage protection level [L-PE]/[N-PE] (U_p)	$\leq 0.7 / \leq 0.7$ kV	$\leq 1.5 / \leq 1.5$ kV	$\leq 1.75 / \leq 1.75$ kV
Max. mains-side overcurrent protection	125 A gG	125 A gG	125 A gG
Approvals	KEMA, UL	KEMA, VDE, UL	KEMA, UL



DEHGuard M TNS ... FM

Modular surge arrester for use in TN-S systems (4+0 configuration); with floating changeover contact.

Type DG M ...	TNS 150 FM	TNS 275 FM	TNS 385 FM
Part No.	952 408	952 405	952 409
SPD according to EN 61643-11 / IEC 61643-11	type 2 / class II	type 2 / class II	type 2 / class II
Max. continuous operating voltage (a.c.) (U_c)	150 V (50 / 60 Hz)	275 V (50 / 60 Hz)	385 V (50 / 60 Hz)
Nominal discharge current (8/20 μ s) (I_n)	15 kA	20 kA	20 kA
Max. discharge current (8/20 μ s) (I_{max})	40 kA	40 kA	40 kA
Voltage protection level [L-PE]/[N-PE] (U_p)	$\leq 0.7 / \leq 0.7$ kV	$\leq 1.5 / \leq 1.5$ kV	$\leq 1.75 / \leq 1.75$ kV
Max. mains-side overcurrent protection	125 A gG	125 A gG	125 A gG
Approvals	KEMA, UL	KEMA, VDE, UL	KEMA, UL
Type of remote signalling contact	changeover contact	changeover contact	changeover contact



DEHGuard M H TT ... (FM)

Modular surge arrester with a high total discharge capacity in the N-PE path for TT and TN-S systems (3+1 configuration); meets the increased safety requirements by higher discharge capability; with floating remote signalling contact.

Type DG M ...	H TT 275	H TT 275 FM
Part No.	952 381	952 385
SPD according to EN 61643-11 / IEC 61643-11	type 2 / class II	type 2 / class II
Max. continuous operating voltage (a.c.) [L-N] (U_c)	275 V (50 / 60 Hz)	275 V (50 / 60 Hz)
Nominal discharge current (8/20 μ s) [L-N] (I_n)	20 kA	20 kA
Nominal discharge current (8/20 μ s) [N-PE] (I_n)	80 kA	80 kA
Max. discharge current (8/20 μ s) [L-N] (I_{max})	40 kA	40 kA
Max. discharge current (8/20 μ s) [N-PE] (I_{max})	120 kA	120 kA
Lightning impulse current (10/350 μ s) [N-PE] (I_{imp})	40 kA	40 kA
Voltage protection level [L-N]/[N-PE] (U_p)	$\leq 1.5 / \leq 1.5$ kV	$\leq 1.5 / \leq 1.5$ kV
Max. mains-side overcurrent protection	125 A gG	125 A gG
Approvals	KEMA	KEMA
Type of remote signalling contact	—	changeover contact



DEHGuard M TT ...

Modular surge arrester for use in TT and TN-S systems (3+1 configuration).

Type DG M ...	TT 150	TT 275	TT 320	TT 385
Part No.	952 323	952 310	952 320	952 311
SPD according to EN 61643-11 / IEC 61643-11	type 2 / class II	type 2 / class II	type 2 / class II	type 2 / class II
Max. continuous operating voltage (a.c.) [L-N] (U_c)	150 V (50 / 60 Hz)	275 V (50 / 60 Hz)	320 V (50 / 60 Hz)	385 V (50 / 60 Hz)
Nominal discharge current (8/20 μ s) (I_n)	15 kA	20 kA	20 kA	20 kA
Max. discharge current (8/20 μ s) (I_{max})	40 kA	40 kA	40 kA	40 kA
Lightning impulse current (10/350 μ s) [N-PE] (I_{imp})	12 kA	12 kA	12 kA	12 kA
Voltage protection level [L-N]/[N-PE] (U_p)	$\leq 0.7 / \leq 1.5$ kV	$\leq 1.5 / \leq 1.5$ kV	$\leq 1.5 / \leq 1.5$ kV	$\leq 1.75 / \leq 1.5$ kV
Max. mains-side overcurrent protection	125 A gG	125 A gG	125 A gG	125 A gG
Approvals	—	KEMA, VDE, UL	KEMA	KEMA, UL



DEHNGuard M TT ... FM

Modular surge arrester for use in TT and TN-S systems (3+1 configuration); with floating remote signalling contact.



Type DG M ...	TT 150 FM	TT 275 FM	TT 320 FM	TT 385 FM
Part No.	952 328	952 315	952 325	952 316
SPD according to EN 61643-11 / IEC 61643-11	type 2 / class II	type 2 / class II	type 2 / class II	type 2 / class II
Max. continuous operating voltage (a.c.) [L-N] (U_C)	150 V (50 / 60 Hz)	275 V (50 / 60 Hz)	320 V (50 / 60 Hz)	385 V (50 / 60 Hz)
Nominal discharge current (8/20 μ s) (I_n)	15 kA	20 kA	20 kA	20 kA
Max. discharge current (8/20 μ s) (I_{max})	40 kA	40 kA	40 kA	40 kA
Lightning impulse current (10/350 μ s) [N-PE] (I_{imp})	12 kA	12 kA	12 kA	12 kA
Voltage protection level [L-N]/[N-PE] (U_P)	$\leq 0.7 / \leq 1.5$ kV	$\leq 1.5 / \leq 1.5$ kV	$\leq 1.5 / \leq 1.5$ kV	$\leq 1.75 / \leq 1.5$ kV
Max. mains-side overcurrent protection	125 A gG	125 A gG	125 A gG	125 A gG
Approvals	UL	KEMA, VDE, UL	KEMA	KEMA, UL
Type of remote signalling contact	changeover contact	changeover contact	changeover contact	changeover contact

DEHNGuard M TN ...

Modular surge arrester for use in single-phase TN systems (2+0 configuration).



Type DG M ...	TN 150	TN 275
Part No.	952 201	952 200
SPD according to EN 61643-11 / IEC 61643-11	type 2 / class II	type 2 / class II
Max. continuous operating voltage (a.c.) (U_C)	150 V (50 / 60 Hz)	275 V (50 / 60 Hz)
Nominal discharge current (8/20 μ s) (I_n)	15 kA	20 kA
Max. discharge current (8/20 μ s) (I_{max})	40 kA	40 kA
Voltage protection level [L-PE]/[N-PE] (U_P)	$\leq 0.7 / \leq 0.7$ kV	$\leq 1.5 / \leq 1.5$ kV
Max. mains-side overcurrent protection	125 A gG	125 A gG
Approvals	KEMA, UL	KEMA, VDE, UL

DEHNGuard M TN ... FM

Modular surge arrester for use in single-phase TN systems (2+0 configuration); with floating remote signalling contact.



Type DG M ...	TN 150 FM	TN 275 FM
Part No.	952 206	952 205
SPD according to EN 61643-11 / IEC 61643-11	type 2 / class II	type 2 / class II
Max. continuous operating voltage (a.c.) (U_C)	150 V (50 / 60 Hz)	275 V (50 / 60 Hz)
Nominal discharge current (8/20 μ s) (I_n)	15 kA	20 kA
Max. discharge current (8/20 μ s) (I_{max})	40 kA	40 kA
Voltage protection level [L-PE]/[N-PE] (U_P)	$\leq 0.7 / \leq 0.7$ kV	$\leq 1.5 / \leq 1.5$ kV
Max. mains-side overcurrent protection	125 A gG	125 A gG
Approvals	KEMA, UL	KEMA, VDE, UL
Type of remote signalling contact	changeover contact	changeover contact

DEHNGuard M H TT 2P ... (FM)

Modular surge arrester with a high total discharge capacity in the N-PE path for TT and TN systems (1+1 configuration); meets the increased safety requirements by higher discharge capability; with floating remote signalling contact.



Type DG M ...	H TT 2P 275	H TT 2P 275 FM
Part No.	952 181	952 185
SPD according to EN 61643-11 / IEC 61643-11	type 2 / class II	type 2 / class II
Max. continuous operating voltage (a.c.) [L-N] (U_C)	275 V (50 / 60 Hz)	275 V (50 / 60 Hz)
Nominal discharge current (8/20 μ s) [L-N] (I_n)	20 kA	20 kA
Nominal discharge current (8/20 μ s) [N-PE] (I_n)	80 kA	80 kA
Max. discharge current (8/20 μ s) [L-N] (I_{max})	40 kA	40 kA
Max. discharge current (8/20 μ s) [N-PE] (I_{max})	120 kA	120 kA
Lightning impulse current (10/350 μ s) [N-PE] (I_{imp})	40 kA	40 kA
Voltage protection level [L-N]/[N-PE] (U_P)	$\leq 1.5 / \leq 1.5$ kV	$\leq 1.5 / \leq 1.5$ kV
Max. mains-side overcurrent protection	125 A gG	125 A gG
Approvals	KEMA	KEMA
Type of remote signalling contact	—	changeover contact

DEHNGuard M TT 2P ...

Modular surge arrester for use in single-phase TT and TN systems (1+1 configuration).



Type DG M ...	TT 2P 275	TT 2P 320	TT 2P 385
Part No.	952 110	952 130	952 111
SPD according to EN 61643-11 / IEC 61643-11	type 2 / class II	type 2 / class II	type 2 / class II
Max. continuous operating voltage (a.c.) [L-N] (U_C)	275 V (50 / 60 Hz)	320 V (50 / 60 Hz)	385 V (50 / 60 Hz)
Nominal discharge current (8/20 μ s) (I_n)	20 kA	20 kA	20 kA
Max. discharge current (8/20 μ s) (I_{max})	40 kA	40 kA	40 kA
Lightning impulse current (10/350 μ s) [N-PE] (I_{imp})	12 kA	12 kA	12 kA
Voltage protection level [L-N]/[N-PE] (U_P)	$\leq 1.5 / \leq 1.5$ kV	$\leq 1.5 / \leq 1.5$ kV	$\leq 1.75 / \leq 1.5$ kV
Max. mains-side overcurrent protection	125 A gG	125 A gG	125 A gG
Approvals	KEMA, VDE, UL	KEMA	KEMA

Surge Arresters – Type 2

DEHNgard M TT 2P ... FM

Modular surge arrester for use in single-phase TT and TN systems (1+1 configuration); with floating remote signalling contact.

Type DG M ...	TT 2P 275 FM	TT 2P 320 FM	TT 2P 385 FM
Part No.	952 115	952 135	952 116
SPD according to EN 61643-11 / IEC 61643-11	type 2 / class II	type 2 / class II	type 2 / class II
Max. continuous operating voltage (a.c.) [L-N] (U_c)	275 V (50 / 60 Hz)	320 V (50 / 60 Hz)	385 V (50 / 60 Hz)
Nominal discharge current (8/20 μ s) (I_n)	20 kA	20 kA	20 kA
Max. discharge current (8/20 μ s) (I_{max})	40 kA	40 kA	40 kA
Lightning impulse current (10/350 μ s) [N-PE] (I_{imp})	12 kA	12 kA	12 kA
Voltage protection level [L-N]/[N-PE] (U_p)	$\leq 1.5 / \leq 1.5$ kV	$\leq 1.5 / \leq 1.5$ kV	$\leq 1.75 / \leq 1.5$ kV
Max. mains-side overcurrent protection	125 A gG	125 A gG	125 A gG
Approvals	KEMA, VDE, UL	KEMA	KEMA
Type of remote signalling contact	changeover contact	changeover contact	changeover contact



DEHNgard M WE ... (FM)

Modular surge arrester (3+0 configuration) with a rated varistor voltage $U_{mov} = 750$ V a.c.; FM version with floating remote signalling contact.

Type DG M ...	WE 600	WE 600 FM
Part No.	952 302	952 307
SPD according to EN 61643-11 / IEC 61643-11	type 2 / class II	type 2 / class II
Max. continuous operating voltage (a.c.) (U_c)	600 V (50 / 60 Hz)	600 V (50 / 60 Hz)
Rated varistor voltage (U_{mov})	750 V	750 V
Nominal discharge current (8/20 μ s) (I_n)	15 kA	15 kA
Max. discharge current (8/20 μ s) (I_{max})	25 kA	25 kA
Voltage protection level (U_p)	≤ 3 kV	≤ 3 kV
Max. mains-side overcurrent protection	100 A gG	100 A gG
Approvals	KEMA, UL	KEMA, UL
Type of remote signalling contact	—	changeover contact



Accessories for DEHNgard modular

Varistor-Based Protection Module

Varistor-based protection module for DEHNgard M ... and DEHNgard S ... surge arresters.

Type	DG MOD 150	DG MOD 320	DG MOD 385	DG MOD 440
Part No.	952 012	952 013	952 014	952 015
Max. continuous operating voltage (a.c.) (U_c)	150 V	320 V	385 V	440 V



Varistor-Based Protection Module for DEHNgard M (S) WE

Varistor-based protection module for DEHNgard M WE ... and DEHNgard S WE ... surge arresters with a rated varistor voltage $U_{mov} = 750$ V a.c.

Type	DG MOD 750
Part No.	952 017
Max. continuous operating voltage (a.c.) (U_c)	600 V



N-PE Spark-Gap-Based Protection Module for DEHNgard M H TT ...

N-PE spark-gap-based protection module with a high discharge capacity for two-pole and four-pole DEHNgard DG M H TT ... surge arresters.

Type	DG MOD H NPE
Part No.	952 081
Max. continuous operating a.c. voltage (U_c)	255 V



N-PE Spark-Gap-Based Protection Module for DEHNgard M TT ...

N-PE spark-gap-based protection module for two-pole and four-pole DEHNgard DG M TT ... surge arresters.

Type	DG MOD NPE
Part No.	952 050
Max. continuous operating voltage (a.c.) (U_c)	255 V





DEHNgard 5 kA (NL)



For protecting low voltage consumer installations against surges. For installation in conformity with the lightning protection zone concept at the boundaries from $O_B - 1$ and higher.

- High reliability due to "Thermo Dynamic Control" monitoring system
- Easy installation and retrofitting thanks to narrow design (width of 18 / 36 mm)
- Application-optimised discharge capacity of 5 kA (I_n) / 15 kA (I_{max}) (8/20 μ s) per pole
- Energy coordination with other arresters of the Red/Line family
- Operating state / fault indication by green / red indicator flag in the inspection window
- Vibration and shock-tested according to EN 60068-2

DG TT 2P 5 275 (NL): Compact surge arrester for single-phase TT and TN systems (1+1 configuration)

DG TT 5 275 (NL): Compact surge arrester for TT and TN-S systems (3+1 configuration)

The compact surge arresters of the DEHNgard TT 5 275 series complement the proven DEHNgard M family for applications with reduced technical parameters.

DEHNgard TT ... 5 275 arresters take up little space and are therefore ideally suited for retrofitting in existing installations and applications with restricted space. Consequently, the devices can be used to protect individual parts of installations (e.g. lighting systems or pumps). In case of multi-phase application, e.g. in TT systems (3+1), the arresters only require two modules. Since the devices can be used up to 63 A without an additional backup fuse, easy and cost-optimised installation of surge protective devices is ensured.

In this context, the safety-relevant features of the DEHNgard series have not been neglected. The DEHNgard 5 kA devices feature a "Thermo

Dynamic Control" monitoring device which meets the high safety standards for surge arresters.

The dual Thermo Dynamic Control monitoring device was not only developed on the basis of applicable national and international product standards, but also reflects decades of experience in the world market of surge protective devices and considers many practical applications where arresters might be damaged.

The standard mechanical operating state / fault indication reliably indicates the status of the surge protective device.

Consequently, the devices of the DEHNgard TT 5 275 series are ideally suited for retrofitting, applications with restricted space and reduced technical requirements.



DEHNgard TT 2P 5 275 (NL)

Compact surge arrester for single-phase TT and TN systems (1+1 circuit); version NL with neutral left.

Type DG TT ...	2P 5 275	2P 5 275 NL
Part No.	900 450	900 458
SPD according to EN 61643-11	type 2	type 2
Max. continuous operating voltage (a.c.) [L-N] (U_c)	275 V (50 / 60 Hz)	275 V (50 / 60 Hz)
Max. continuous operating voltage (a.c.) [N-PE] (U_c)	255 V (50 / 60 Hz)	255 V (50 / 60 Hz)
Nominal discharge current (8/20 μ s) [L-N] (I_n)	5 kA	5 kA
Nominal discharge current (8/20 μ s) [N-PE] (I_n)	20 kA	20 kA
Max. discharge current (8/20 μ s) [L-N] (I_{max})	15 kA	15 kA
Max. discharge current (8/20 μ s) [N-PE] (I_{max})	40 kA	40 kA
Voltage protection level (U_p)	≤ 1.5 kV	≤ 1.5 kV
Max. mains-side overcurrent protection	MCB C 63 A	MCB C 63 A



DEHNgard TT 5 275 (NL)

Compact surge arrester for TT and TN-S systems (3+1 circuit); version NL with neutral left.

Type DG TT ...	5 275	5 275 NL
Part No.	900 455	900 459
SPD according to EN 61643-11	type 2	type 2
Max. continuous operating voltage (a.c.) [L-N] (U_c)	275 V (50 / 60 Hz)	275 V (50 / 60 Hz)
Max. continuous operating voltage (a.c.) [N-PE] (U_c)	255 V (50 / 60 Hz)	255 V (50 / 60 Hz)
Nominal discharge current (8/20 μ s) [L-N] (I_n)	5 kA	5 kA
Nominal discharge current (8/20 μ s) [N-PE] (I_n)	20 kA	20 kA
Max. discharge current (8/20 μ s) [L-N] (I_{max})	15 kA	15 kA
Max. discharge current (8/20 μ s) [N-PE] (I_{max})	40 kA	40 kA
Voltage protection level (U_p)	≤ 1.5 kV	≤ 1.5 kV
Max. mains-side overcurrent protection	MCB C 63 A	MCB C 63 A



DEHNgard S

- Multi-purpose surge arrester consisting of a base part and a plug-in protection module
- High discharge capacity due to heavy-duty zinc oxide varistor
- High reliability due to "Thermo Dynamic Control" SPD monitoring device
- Energy coordination with other arresters of the Red/Line product family
- Operating state / fault indication by green / red indicator flag in the inspection window
- Narrow (modular) design acc. to DIN 43880
- Multifunctional terminals for connecting conductors and busbars
- Easy replacement of protection modules due to module locking system with module release button
- Vibration and shock-tested according to EN 60068-2



For protecting low-voltage consumer installations against surges. For installation in conformity with the lightning protection zone concept at the boundaries from $O_B - 1$ and higher.

DEHNgard S ...: Pluggable surge arrester consisting of a base part and a plug-in protection module
DEHNgard S ... FM: With remote signalling contact for monitoring device (floating changeover contact)

The universal features characterise the single-pole devices of the DEHNgard S product family. Whether as a single device or in combination with other devices – DEHNgard S surge arresters always provide adequate protection. The modern Red/Line family design and its universal features ensure safety and easy application for the user. The module release button and the approved "Thermo Dynamic Control" SPD monitoring device with dual tripping performance characterise the devices of the DEHNgard S series.

Decades of experience in the world market of surge arresters has further improved the latest DEHNgard generation compared to the previous devices.

The unique module locking system fixes the protection module to the base part. Neither vibration during transport nor the enormous forces of discharge can loosen this connection. Nevertheless, the modules can be easily replaced without tools by simply pressing the easy-to-use module release button of the protection modules.

Every base part and protection module is mechanically coded to guard against installing an incorrect module.

As with all DEHNgard surge arresters, the user of DEHNgard S can rely on the dual "Thermo Dynamic Control" SPD monitoring device which ensures a maximum degree of safety, even under harsh environmental conditions. The green and red indicator flags show the operating state of DEHNgard S surge arresters. Apart from this standard visual indication, DEHNgard S ... FM features a three-pole remote signalling terminal. As the remote signalling contact is designed as a floating changeover contact, the remote signal can, depending on the circuit concept, be used as a make or break contact. The multifunctional terminals of DEHNgard S surge arresters are suitable for connecting conductors and busbars, allowing easy wiring with other DIN rail mounted devices. Thus, a wide range of applications can be easily connected in series according to IEC 60364-5-53 for optimal protection.

DEHNgard S ...

Pluggable single-pole surge arrester consisting of a base part and a plug-in protection module.

General technical data:				
SPD according to EN 61643-11 / IEC 61643-11	type 2 / class II			
Type DG S ...	48	75	150	275
Part No.	952 078	952 071	952 072	952 070
Max. continuous operating voltage (a.c.) (U_C)	48 V (50 / 60 Hz)	75 V (50 / 60 Hz)	150 V (50 / 60 Hz)	275 V (50 / 60 Hz)
Nominal discharge current (8/20 μ s) (I_n)	7.5 kA	10 kA	15 kA	20 kA
Max. discharge current (8/20 μ s) (I_{max})	25 kA	40 kA	40 kA	40 kA
Voltage protection level (U_P)	≤ 0.33 kV	≤ 0.4 kV	≤ 0.7 kV	≤ 1.5 kV
Max. mains-side overcurrent protection	125 A gG	125 A gG	125 A gG	125 A gG
Approvals	—	KEMA, VDE, UL, CSA	KEMA, VDE, UL, CSA	KEMA, VDE, UL, CSA
Type DG S ...	320	385	440	600
Part No.	952 073	952 074	952 075	952 076
Max. continuous operating voltage (a.c.) (U_C)	320 V (50 / 60 Hz)	385 V (50 / 60 Hz)	440 V (50 / 60 Hz)	600 V (50 / 60 Hz)
Nominal discharge current (8/20 μ s) (I_n)	20 kA	20 kA	20 kA	15 kA
Max. discharge current (8/20 μ s) (I_{max})	40 kA	40 kA	40 kA	30 kA
Voltage protection level (U_P)	≤ 1.5 kV	≤ 1.75 kV	≤ 2 kV	≤ 2.5 kV
Max. mains-side overcurrent protection	125 A gG	125 A gG	125 A gG	100 A gG
Approvals	KEMA, VDE, UL, CSA	KEMA, VDE, UL, CSA	KEMA, VDE, UL, CSA	KEMA, VDE, UL, CSA



DEHNgard S ... FM

Pluggable single-pole surge arrester consisting of a base part and a plug-in protection module; with floating remote signalling contact.

General technical data:				
SPD according to EN 61643-11 / IEC 61643-11	type 2 / class II			
Type of remote signalling contact	changeover contact			
Type DG S ...	48 FM	75 FM	150 FM	275 FM
Part No.	952 098	952 091	952 092	952 090
Max. continuous operating voltage (a.c.) (U_c)	48 V (50 / 60 Hz)	75 V (50 / 60 Hz)	150 V (50 / 60 Hz)	275 V (50 / 60 Hz)
Nominal discharge current (8/20 μ s) (I_n)	7.5 kA	10 kA	15 kA	20 kA
Max. discharge current (8/20 μ s) (I_{max})	25 kA	40 kA	40 kA	40 kA
Voltage protection level (U_p)	≤ 0.33 kV	≤ 0.4 kV	≤ 0.7 kV	≤ 1.5 kV
Max. mains-side overcurrent protection	125 A gG	125 A gG	125 A gG	125 A gG
Approvals	—	KEMA, VDE, UL, CSA	KEMA, VDE, UL, CSA	KEMA, VDE, UL, CSA
Type DG S ...	320 FM	385 FM	440 FM	600 FM
Part No.	952 093	952 094	952 095	952 096
Max. continuous operating voltage (a.c.) (U_c)	320 V (50 / 60 Hz)	385 V (50 / 60 Hz)	440 V (50 / 60 Hz)	600 V (50 / 60 Hz)
Nominal discharge current (8/20 μ s) (I_n)	20 kA	20 kA	20 kA	15 kA
Max. discharge current (8/20 μ s) (I_{max})	40 kA	40 kA	40 kA	30 kA
Voltage protection level (U_p)	≤ 1.5 kV	≤ 1.75 kV	≤ 2 kV	≤ 2.5 kV
Max. mains-side overcurrent protection	125 A gG	125 A gG	125 A gG	100 A gG
Approvals	KEMA, VDE, UL, CSA	KEMA, VDE, UL, CSA	KEMA, VDE, UL, CSA	KEMA, VDE, UL, CSA

**DEHNgard S WE 600 (FM)**

Pluggable single-pole surge arrester with a rated varistor voltage $U_{mov} = 750$ V a.c., consisting of base part and a plug-in protection module; FM version with floating remote signalling contact.

Type DG S ...	WE 600	WE 600 FM
Part No.	952 077	952 097
SPD according to EN 61643-11 / IEC 61643-11	type 2 / class II	type 2 / class II
Max. continuous operating voltage (a.c.) (U_c)	600 V (50 / 60 Hz)	600 V (50 / 60 Hz)
Nominal discharge current (8/20 μ s) (I_n)	15 kA	15 kA
Max. discharge current (8/20 μ s) (I_{max})	25 kA	25 kA
Voltage protection level (U_p)	≤ 3 kV	≤ 3 kV
Max. mains-side overcurrent protection	100 A gG	100 A gG
Approvals	KEMA, UL, CSA	KEMA, UL, CSA
Type of remote signalling contact	—	changeover contact

**Accessories for DEHNgard S****Varistor-Based Protection Module**

Varistor-based protection module for DEHNgard M ... and DEHNgard S ... surge arresters.

Type	DG MOD 48	DG MOD 75	DG MOD 150	DG MOD 320
Part No.	952 018	952 011	952 012	952 013
Max. continuous operating voltage (a.c.) (U_c)	48 V	75 V	150 V	320 V
Type	DG MOD 385	DG MOD 440	DG MOD 600	
Part No.	952 014	952 015	952 016	
Max. continuous operating voltage (a.c.) (U_c)	385 V	440 V	600 V	

**Varistor-Based Protection Module for DEHNgard M (S) WE**

Varistor-based protection module for DEHNgard M WE ... and DEHNgard S WE ... surge arresters with a rated varistor voltage $U_{mov} = 750$ V a.c.

Type	DG MOD 750
Part No.	952 017
Max. continuous operating voltage (a.c.) (U_c)	600 V





DEHNgard S ... VA

- Multi-purpose surge arrester consisting of a base part and a plug-in protection module
- Leakage-current-free series connection of a varistor and a spark gap in the pluggable protection module
- High reliability due to "Thermo Dynamic Control" SPD monitoring device
- Energy coordination with other arresters of the Red/Line product family
- Easy replacement of protection modules without tools due to module locking system with module release button
- Narrow (modular) design according to DIN 43880
- Multifunctional terminal for connecting conductors and busbars



For protecting low-voltage consumer installations against surges. For installation in conformity with the lightning protection zone concept at the boundaries from $O_B - 1$ and higher.

DEHNgard S ... VA: Modular single-pole surge arrester with a varistor connected in series with a spark gap in the pluggable protection module

DEHNgard S ... VA FM: Modular single-pole surge arrester with a varistor connected in series with a spark gap in the pluggable protection module; with remote signalling contact for monitoring device (floating changeover contact)

The single-pole DEHNgard S ... VA surge arresters are an ideal supplement to the proven DEHNgard product families. The special series connection of a spark gap and a varistor in the protection module opens up new fields of application. It is advisable to use DEHNgard S ... VA devices to protect, for example, systems with permanent insulation monitoring and the traction power lines in railway systems where complete absence of leakage currents is required. DEHNgard S ... VA surge arresters are also suited for protecting power line communication systems.

Multifunctional terminals provide almost unlimited flexibility in terms of connection to one another, but also to other DIN rail mounted devices on the distribution board. However, it is not only flexibility that characterises the DEHNgard S ... VA family. Its distinctive performance parameters set standards worldwide:

A high discharge capacity, complete absence of leakage currents, a low voltage protection level and the dual "Thermo Dynamic Control" monitoring and disconnection device describe the high level of device safety.

The DEHN-specific "Thermo Dynamic Control" disconnecter ensures that the arresters enter a safe and isolated state, even in case of extreme overload. For this purpose, the surface temperature of the heavy-duty varistor and the intensity of the discharge current are used for evaluation. In addition to the standard visual indication with red and green indicator flags, the DEHNgard S VA ... FM devices feature a three-pole remote signalling terminal. As the remote signalling contact is designed as a floating changeover contact, the remote signal can, depending on the circuit concept, be used as a make or break contact.

DEHNgard S VA

Modular single-pole surge arrester with a varistor connected in series with a spark gap in the pluggable protection module.

Type DG S ...	75 VA	275 VA	385 VA
Part No.	952 080	952 082	952 084
SPD according to EN 61643-11 / IEC 61643-11	type 2 / class II	type 2 / class II	type 2 / class II
Max. continuous operating voltage (a.c.) (U_C)	75 V (50 / 60 Hz)	275 V (50 / 60 Hz)	385 V (50 / 60 Hz)
Nominal discharge current (8/20 μ s) (I_n)	10 kA	10 kA	10 kA
Max. discharge current (8/20 μ s) (I_{max})	20 kA	20 kA	20 kA
Voltage protection level (U_P)	≤ 1.1 kV	≤ 1.5 kV	≤ 1.75 kV
Max. mains-side overcurrent protection	100 A gG	100 A gG	100 A gG



DEHNgard S VA FM

Modular single-pole surge arrester with a varistor connected in series with a spark gap in the pluggable protection module; with floating remote signalling contact.

Type DG S ...	75 VA FM	275 VA FM	385 VA FM
Part No.	952 085	952 087	952 089
SPD according to EN 61643-11 / IEC 61643-11	type 2 / class II	type 2 / class II	type 2 / class II
Max. continuous operating voltage (a.c.) (U_C)	75 V (50 / 60 Hz)	275 V (50 / 60 Hz)	385 V (50 / 60 Hz)
Nominal discharge current (8/20 μ s) (I_n)	10 kA	10 kA	10 kA
Max. discharge current (8/20 μ s) (I_{max})	20 kA	20 kA	20 kA
Voltage protection level (U_P)	≤ 1.1 kV	≤ 1.5 kV	≤ 1.75 kV
Max. mains-side overcurrent protection	100 A gG	100 A gG	100 A gG



Accessories for DEHNgard S ... VA

Varistor-Based Protection Module for DEHNgard S ... VA

Protection module for DEHNgard S ... VA arresters comprising a varistor connected in series with a spark gap.

Type	DG MOD 75 VA	DG MOD 275 VA	DG MOD 385 VA
Part No.	952 025	952 027	952 029
Max. continuous operating voltage (a.c.) (U_C)	75 V	275 V	385 V





DEHNgard SE H ... FM

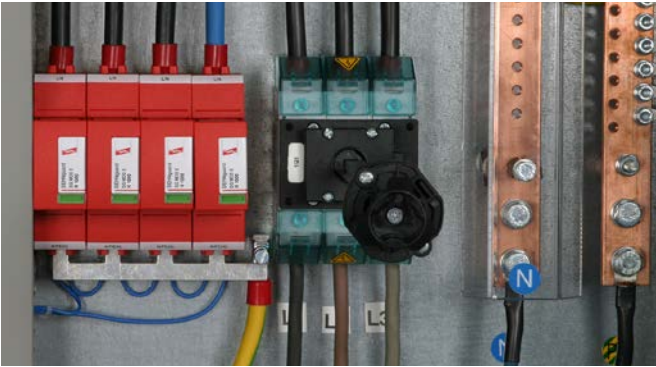

Single-pole surge arrester for protecting low-voltage consumer installations from surges. For installation in conformity with the lightning protection zone concept at the boundaries from $O_B - 1$ and higher.

- Universal surge arrester comprising a base part and a plug-in protection module
- Energy coordination with other arresters of the Red/Line product family
- High discharge capacity
- High reliability due to "Thermo Dynamic Control" SPD monitoring device
- Easy replacement of protection modules without tools due to module locking system with module release button

DEHNgard SE H 1000 FM: Pluggable single-pole surge arrester with a high discharge capacity comprising a base part and a plug-in protection module; with remote signalling contact for monitoring unit (floating changeover contact)

DEHNgard SE H 1000 VA FM: Pluggable single-pole surge arrester with a high discharge capacity and a varistor connected in series with a spark gap comprising a base part and a plug-in protection module; with remote signalling contact for monitoring unit (floating changeover contact)

DEHNgard SE H 1000 FM is a powerful type 2 arrester specifically designed for higher system voltages and higher discharge currents. This arrester is universally applicable due to its low voltage protection level and its design a single-pole device.

DEHNgard SE H 1000 VA FM is a powerful type 2 arrester specifically designed for higher system voltages and higher discharge currents. Thanks to the high nominal voltage and the series connection of a varistor and a gas discharge tube, it is ideally suited for wind turbines (rotor and inverter) and for other applications such as PV systems, railways or cable cars with higher voltages where no leakage current whatsoever can be tolerated.

All necessary components such as earthing clips EB 1 ... 1.5 with a width of 1.5 standard DIN modules are available as accessories to ensure the correct connection for the relevant system configuration as per IEC 60364-5-53.

The arresters feature a three-pole remote signalling terminal. As the remote signalling contact is designed as a floating changeover contact, the remote signal can, depending on the circuit concept, be used as a make or break contact.

DEHNgard SE H 1000 FM

Pluggable single-pole surge arrester comprising a base part and a plug-in protection module; with floating remote signalling contact.



Type DG SE H 1000 ...	FM
Part No.	952 938
SPD according to EN 61643-11 / IEC 61643-11	type 2 / class II
Max. continuous operating voltage (a.c.) (U_c)	1000 V (50 / 60 Hz)
Nominal discharge current (8/20 μ s) (I_n)	20 kA
Max. discharge current (8/20 μ s) (I_{max})	40 kA
Voltage protection level (U_p)	≤ 4.5 kV
Max. mains-side overcurrent protection	100 A gG
Operating state / fault indication	green / red
Type of remote signalling contact	changeover contact

Surge Arresters – Type 2

DEHNgard SE H 1000 VA FM

Pluggable single-pole surge arrester comprising a base part and a plug-in protection module; with floating remote signalling contact. Series connection of a varistor and a gas discharge tube.

Type DG SE H 1000 ...	VA FM
Part No.	952 940
SPD according to EN 61643-11 / IEC 61643-11	type 2 / class II
Max. continuous operating voltage (a.c.) (U_c)	1000 V (50 / 60 Hz)
Nominal discharge current (8/20 μ s) (I_n)	15 kA
Max. discharge current (8/20 μ s) (I_{max})	40 kA
Voltage protection level (U_p)	≤ 5 kV
Max. mains-side overcurrent protection	100 A gG
Operating state / fault indication	green / red
Approvals	UL
Type of remote signalling contact	changeover contact
Supplementary data:	
– Sparkover voltage gas discharge tube (U_{agmin})	2200 V



Accessories for DEHNgard SE H ... FM

Varistor-Based Protection Module for DEHNgard SE H ... FM

Type	DG MOD E H 1000	DG MOD E H 1000 VA
Part No.	952 908	952 918
Max. continuous operating voltage (d.c.) (U_c)	1000 V	1000 V



Earthing Clip for 1.5-module Enclosures, single-phase, two-pole

Earthing clip for connecting the earth terminal of e.g. two SPDs with 1.5-module enclosure to earth, with terminal.

Type	EB 1 2 1.5
Part No.	900 460
Dimensions	34 x 60 x 28 mm
Terminal	up to 25 mm ²



Earthing Clip for 1.5-module Enclosures, single-phase, three-pole

Earthing clip for connecting the earth terminal of e.g. three SPDs with 1.5-module enclosure to earth, with terminal.

Type	EB 1 3 1.5
Part No.	900 418
Dimensions	34 x 85 x 28 mm
Terminal	up to 25 mm ²



Earthing Clip for 1.5-module Enclosures, single-phase, four-pole

Earthing clip for connecting the earth terminal of e.g. four SPDs with 1.5-module enclosure to earth, with terminal.

Type	EB 1 4 1.5
Part No.	900 429
Dimensions	34 x 112 x 28 mm
Terminal	up to 25 mm ²





DEHNgard modular for North America

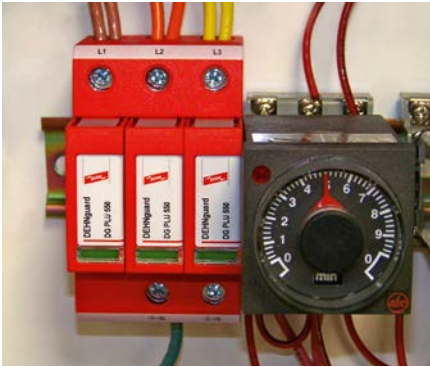

- **Prewired complete unit consisting of a base part and plug-in protection modules**
- **No need for additional overcurrent protection devices**
- **Short circuit current rating (SCCR) 200 kA**
- **ANSI/UL 1449 – 4th Ed. Open-Type 1 SPD**
- **High discharge capacity due to heavy-duty zinc oxide varistors (I_{max} 50 kA 8x20 μ s)**
- **High reliability due to "Thermo Dynamic Control" SPD monitoring device**

DEHNgard SU 1P ...: Modular single-pole surge arrester for application in Single Phase electrical systems

DEHNgard MU SP ...: Modular surge arrester for application in Split Phase systems

DEHNgard MU SPN ...: Modular surge arrester for application in Split Phase systems (with N protected)

DEHNgard MU CGD ...: Modular surge arrester for application in Corner Grounded Delta systems

DEHNgard MU 3PY ...: Modular surge arrester for application in 3 Phase Wye electrical systems

DEHNgard MU 3PD ...: Modular surge arrester for application in 3 Phase Delta electrical systems

DEHNgard MU 3PH ...: Modular surge arrester for application in 3 Phase High-leg Delta systems

DEHNgard ... R: With remote status indicator for monitoring device (Form C / SPDT contact)

The DEHNgard SU/MU ... surge arresters are modular DIN rail mounted SPDs in the functional Red/line family design and set new standards in terms of safety and user-friendliness. The SPDs are UL 1449 4th Edition certified as Type 1 Component Assemblies and are designed for all common electrical power systems. These devices have optimised voltage protection ratings and therefore provide ideal surge protection for the United States and Canadian electrical panel markets.

The enhanced maximum discharge capacity of 50 kA, the high short circuit current rating (SCCR) of 200 kA and the fact that there is no need for additional overcurrent protection devices mean that the DEHNgard SU/MU product family fulfils all the requirements of modern day electrical applications. Besides the variety of features shows that both reliable surge protection and equipment safety are key elements of the modular DEHNgard surge arresters. The application-based product designation makes it considerably easier to choose the correct device for the relevant application as well as the module locking system firmly fixes the protection modules to the base part. Neither vibration during transport nor the enormous electromagnetic forces of discharge can loosen the protection modules. Nevertheless, they can be easily replaced without tools by simply pressing the user-friendly module release button of the protection mod-

ules. Each protective circuit of the multipole surge arresters and each protection module are mechanically coded to guard against installing an incorrect module.

The dual "Thermo Dynamic Control" monitoring device was not only developed on the basis of national and international product standards, but also reflects decades of experience in the world market of surge protective devices and considers practical applications where arresters might be damaged. As with all DEHN surge arresters with "Thermo Dynamic Control", the intensity of the discharge current and the surface temperature of the heavy-duty varistor are evaluated. The visual status indicator with green and red indicator flags shows the availability of every protective circuit. Apart from this standard visual indication, DEHNgard M SU/MU ... FM devices feature a Form C contact (SPDT).

As the remote signalling contact is designed as a floating changeover contact, the remote signal can, depending on the circuit concept, be used as a make or break contact. The surge arresters of the multipole modular DEHNgard MU family feature multifunctional terminals on a standardised spacing of 1 module for the connection of wires and busbars, allowing easy wiring with other DIN rail mounted devices. Thus, a wide range of applications can be easily connected in series for optimal protection.

DEHNgard MU 3PY ... 3W+G

DIN rail mount, pluggable surge arrester consisting of a base part and plug-in protection modules for application in 3 Phase Wye electrical systems



Type DG MU ...	3PY 208 3W+G	3PY 480 3W+G	3PY 600 3W+G
Part No.	908 300	908 314	908 301
SPD classification acc. to ANSI/UL 1449 4 th Ed.	Open-Type 1 SPD	Open-Type 1 SPD	Open-Type 1 SPD
SPD classification acc. to CSA - C22.2 No. 269.1-14	Type 4-1 Component Assembly	Type 4-1 Component Assembly	Type 4-1 Component Assembly
Max. continuous operating voltage AC [L-G] / [L-L] (MCOV)	180 V a.c. / 360 V a.c.	385 V a.c. / 770 V a.c.	510 V a.c. / 1020 V a.c.
Nominal discharge current (8x 20 μ s) (I_n)	20 kA	20 kA	20 kA
Max. discharge current (8/20) (I_{max})	50 kA	50 kA	50 kA
Voltage protection rating [L-G] / [L-L] (VPR)	600 V _{pk} / 1200 V _{pk}	1200 V _{pk} / 2500 V _{pk}	1500 V _{pk} / 3000 V _{pk}
Max. mains-side overcurrent protection	Not needed	Not needed	Not needed
Approvals	UL, CSA	UL, CSA	UL, CSA

DEHNgard MU 3PY ... 3W+G R

DIN rail mount, pluggable surge arrester consisting of a base part and plug-in protection modules for application in 3 Phase Wye electrical systems; has floating Form C (SPDT) remote status contacts

Type DG MU ...	3PY 208 3W+G R	3PY 480 3W+G R	3PY 600 3W+G R
Part No.	908 305	908 319	908 306
SPD classification acc. to ANSI/UL 1449 4 th Ed.	Open-Type 1 SPD	Open-Type 1 SPD	Open-Type 1 SPD
SPD classification acc. to CSA - C22.2 No. 269.1-14	Type 4-1 Component Assembly	Type 4-1 Component Assembly	Type 4-1 Component Assembly
Max. continuous operating voltage AC [L-G] / [L-L] (MCOV)	180 V a.c. / 360 V a.c.	385 V a.c. / 770 V a.c.	510 V a.c. / 1020 V a.c.
Nominal discharge current (8x 20 μs) (I _n)	20 kA	20 kA	20 kA
Max. discharge current (8/20) (I _{max})	50 kA	50 kA	50 kA
Voltage protection rating [L-G] / [L-L] (VPR)	600 V _{pk} / 1200 V _{pk}	1200 V _{pk} / 2500 V _{pk}	1500 V _{pk} / 3000 V _{pk}
Max. mains-side overcurrent protection	Not needed	Not needed	Not needed
Approvals	UL, CSA	UL, CSA	UL, CSA
Remote status contact	Floating (dry), Form C (SPDT)	Floating (dry), Form C (SPDT)	Floating (dry), Form C (SPDT)



DEHNgard MU 3PD ... 3W+G

DIN rail mount, pluggable surge arrester consisting of a base part and plug-in protection modules for application in 3 Phase Delta electrical systems

Type DG MU ...	3PD 480 3W+G	3PD 240 3W+G
Part No.	908 350	908 351
SPD classification acc. to ANSI/UL 1449 4 th Ed.	Open-Type 1 SPD	Open-Type 1 SPD
SPD classification acc. to CSA - C22.2 No. 269.1-14	Type 4-1 Component Assembly	Type 4-1 Component Assembly
Max. continuous operating voltage AC [L-G] / [L-L] (MCOV)	550 V a.c. / 1100 V a.c.	275 V a.c. / 550 V a.c.
Nominal discharge current (8x 20 μs) (I _n)	20 kA	20 kA
Max. discharge current (8/20) (I _{max})	50 kA	50 kA
Voltage protection rating [L-G] / [L-L] (VPR)	1800 V _{pk} / 3000 V _{pk}	800 V _{pk} / 1500 V _{pk}
Max. mains-side overcurrent protection	Not needed	Not needed
Approvals	UL, CSA	UL, CSA



DEHNgard MU 3PD ... 3W+G R

DIN rail mount, pluggable surge arrester consisting of a base part and plug-in protection modules for application in 3 Phase Delta electrical systems; has floating Form C (SPDT) remote status contacts

Type DG MU ...	3PD 480 3W+G R	3PD 240 3W+G R
Part No.	908 355	908 356
SPD classification acc. to ANSI/UL 1449 4 th Ed.	Open-Type 1 SPD	Open-Type 1 SPD
SPD classification acc. to CSA - C22.2 No. 269.1-14	Type 4-1 Component Assembly	Type 4-1 Component Assembly
Max. continuous operating voltage AC [L-G] / [L-L] (MCOV)	550 V a.c. / 1100 V a.c.	275 V a.c. / 550 V a.c.
Nominal discharge current (8x 20 μs) (I _n)	20 kA	20 kA
Max. discharge current (8/20) (I _{max})	50 kA	50 kA
Voltage protection rating [L-G] / [L-L] (VPR)	1800 V _{pk} / 3000 V _{pk}	800 V _{pk} / 1500 V _{pk}
Max. mains-side overcurrent protection	Not needed	Not needed
Approvals	UL, CSA	UL, CSA
Remote status contact	Floating (dry), Form C (SPDT)	Floating (dry), Form C (SPDT)



DEHNgard MU 3PY ... 4W+G

DIN rail mount, pluggable surge arrester consisting of a base part and plug-in protection modules for application in 3 Phase Wye Systems

Type DG MU ...	3PY 208 4W+G	3PY 480 4W+G	3PY 600 4W+G
Part No.	908 340	908 341	908 342
SPD classification acc. to ANSI/UL 1449 4 th Ed.	Open-Type 1 SPD	Open-Type 1 SPD	Open-Type 1 SPD
SPD classification acc. to CSA - C22.2 No. 269.1-14	Type 4-1 Component Assembly	Type 4-1 Component Assembly	Type 4-1 Component Assembly
Max. continuous operating voltage AC [L-N] / [L-G] / [L-L] / [N-G] (MCOV)	180 V a.c. / 360 V a.c. / 360 V a.c. / 180 V a.c.	385 V a.c. / 565 V a.c. / 770 V a.c. / 180 V a.c.	510 V a.c. / 690 V a.c. / 1020 V a.c. / 180 V a.c.
Nominal discharge current (8x 20 μs) (I _n)	20 kA	20 kA	20 kA
Max. discharge current (8/20) (I _{max})	50 kA	50 kA	50 kA
Voltage protection rating [L-N] / [L-G] / [L-L] / [N-G] (VPR)	600 V _{pk} / 1200 V _{pk} / 1200 V _{pk} / 600 V _{pk}	1200 V _{pk} / 1800 V _{pk} / 2500 V _{pk} / 600 V _{pk}	1500 V _{pk} / 2000 V _{pk} / 3000 V _{pk} / 600 V _{pk}
Max. mains-side overcurrent protection	Not needed	Not needed	Not needed
Approvals	UL, CSA	UL, CSA	UL, CSA



DEHNgard MU 3PY ... 4W+ G R

DIN rail mount, pluggable surge arrester consisting of a base part and plug-in protection modules for application in 3 Phase Wye Systems; has floating Form C (SPDT) remote status contacts



Type DG MU ...	3PY 208 4W+G R	3PY 480 4W+G R	3PY 600 4W+G R
Part No.	908 345	908 346	908 347
SPD classification acc. to ANSI/UL 1449 4 th Ed.	Open-Type 1 SPD	Open-Type 1 SPD	Open-Type 1 SPD
SPD classification acc. to CSA - C22.2 No. 269.1-14	Type 4-1 Component Assembly	Type 4-1 Component Assembly	Type 4-1 Component Assembly
Max. continuous operating voltage AC [L-N] / [L-G] / [L-L] / [N-G] (MCOV)	180 V a.c. / 360 V a.c. / 360 V a.c. / 180 V a.c.	385 V a.c. / 565 V a.c. / 770 V a.c. / 180 V a.c.	510 V a.c. / 690 V a.c. / 1020 V a.c. / 180 V a.c.
Nominal discharge current (8x 20 μs) (I _n)	20 kA	20 kA	20 kA
Max. discharge current (8/20) (I _{max})	50 kA	50 kA	50 kA
Voltage protection rating [L-N] / [L-G] / [L-L] / [N-G] (VPR)	600 V _{pk} / 1200 V _{pk} / 1200 V _{pk} / 600 V _{pk}	1200 V _{pk} / 1800 V _{pk} / 2500 V _{pk} / 600 V _{pk}	1500 V _{pk} / 2000 _{pk} V / 3000 _{pk} V / 600 V _{pk}
Max. mains-side overcurrent protection	Not needed	Not needed	Not needed
Approvals	UL, CSA	UL, CSA	UL, CSA
Remote status contact	Floating (dry), Form C (SPDT)	Floating (dry), Form C (SPDT)	Floating (dry), Form C (SPDT)

DEHNgard MU 3PH ... 4W+G

DIN rail mount, pluggable surge arrester consisting of a base part and plug-in protection modules for application in 3 Phase High-leg Delta Systems



Type DG MU ...	3PH 240 4W+G	3PH 480 4W+G
Part No.	908 343	908 344
SPD classification acc. to ANSI/UL 1449 4 th Ed.	Open-Type 1 SPD	Open-Type 1 SPD
SPD classification acc. to CSA - C22.2 No. 269.1-14	Type 4-1 Component Assembly	Type 4-1 Component Assembly
Max. continuous operating voltage AC [L-N] / [H-N] / [L-G] / [H-G] / [L-L] / [L-H] / [N-G]	230 V a.c. / 275 V a.c. / 410 V a.c. / 455 V a.c. / 460 V a.c. / 505 V a.c. / 180 V a.c.	385V a.c. / 510 V a.c. / 565 V a.c. / 690 V a.c. / 770 V a.c. / 895 V a.c. / 180 V a.c.
Nominal discharge current (8x 20 μs) (I _n)	20 kA	20 kA
Max. discharge current (8/20) (I _{max})	50 kA	50 kA
Voltage protection rating [L-N] / [H-N] / [L-G] / [H-G] / [L-L] / [L-H] / [N-G] (VPR)	700 V _{pk} / 800 V _{pk} / 1200 V _{pk} / 1500 V _{pk} / 1500 V _{pk} / 1500 V _{pk} / 600 V _{pk}	1200 V _{pk} / 1500 V _{pk} / 1800 V _{pk} / 2000 V _{pk} / 2500 V _{pk} / 2500 V _{pk} / 600 V _{pk}
Max. mains-side overcurrent protection	Not needed	Not needed
Approvals	UL, CSA	UL, CSA

DEHNgard MU 3PH ... 4W+G R

DIN rail mount, pluggable surge arrester consisting of a base part and plug-in protection modules for application in 3 Phase High-leg Delta Systems; has floating Form C (SPDT) remote status contacts



Type DG MU ...	3PH 240 4W+G R	3PH 480 4W+G R
Part No.	908 348	908 349
SPD classification acc. to ANSI/UL 1449 4 th Ed.	Open-Type 1 SPD	Open-Type 1 SPD
SPD classification acc. to CSA - C22.2 No. 269.1-14	Type 4-1 Component Assembly	Type 4-1 Component Assembly
Max. continuous operating voltage AC [L-N] / [H-N] / [L-G] / [H-G] / [L-L] / [L-H] / [N-G]	230 V a.c. / 275 V a.c. / 410 V a.c. / 455 V a.c. / 460 V a.c. / 505 V a.c. / 180V a.c.	385 V a.c. / 510 V a.c. / 565 V a.c. / 690 V a.c. / 770 V a.c. / 895 V a.c. / 180 V a.c.
Nominal discharge current (8x 20 μs) (I _n)	20 kA	20 kA
Max. discharge current (8/20) (I _{max})	50 kA	50 kA
Voltage protection rating [L-N] / [H-N] / [L-G] / [H-G] / [L-L] / [L-H] / [N-G] (VPR)	700 V _{pk} / 800 V _{pk} / 1200 V _{pk} / 1500 V _{pk} / 1500 V _{pk} / 1500 V _{pk} / 600 V _{pk}	1200 V _{pk} / 1500 V _{pk} / 1800 V _{pk} / 2000 V _{pk} / 2500 V _{pk} / 2500 V _{pk} / 600 V _{pk}
Max. mains-side overcurrent protection	Not needed	Not needed
Approvals	UL, CSA	UL, CSA
Remote status contact	Floating (dry), Form C (SPDT)	Floating (dry), Form C (SPDT)

DEHNgard MU SP ... 3W+G

DIN rail mount, pluggable surge arrester consisting of a base part and plug-in protection modules for application in Split Phase systems



Type DG MU ...	SP 240 3W+G	SP 480 3W+G
Part No.	908 190	908 192
SPD classification acc. to ANSI/UL 1449 4 th Ed.	Open-Type 1 SPD	Open-Type 1 SPD
SPD classification acc. to CSA - C22.2 No. 269.1-14	Type 4-1 Component Assembly	Type 4-1 Component Assembly
Max. continuous operating voltage AC [L-G] / [L-L] (MCOV)	230 V a.c. / 460 V a.c.	385 V a.c. / 770 V a.c.
Nominal discharge current (8x 20 μs) (I _n)	20 kA	20 kA
Max. discharge current (8/20) (I _{max})	50 kA	50 kA
Voltage protection rating [L-G] / [L-L] (VPR)	700 V _{pk} / 1500 V _{pk}	1200 V _{pk} / 2500 V _{pk}
Max. mains-side overcurrent protection	Not needed	Not needed
Approvals	UL, CSA	UL, CSA

DEHNguard MU SP ... 3W+G R

DIN rail mount, pluggable surge arrester consisting of a base part and plug-in protection modules for application in Split Phase systems; has floating Form C (SPDT) remote status contacts

Type DG MU ...	SP 240 3W+G R	SP 480 3W+G R
Part No.	908 195	908 197
SPD classification acc. to ANSI/UL 1449 4 th Ed.	Open-Type 1 SPD	Open-Type 1 SPD
SPD classification acc. to CSA - C22.2 No. 269.1-14	Type 4-1 Component Assembly	Type 4-1 Component Assembly
Max. continuous operating voltage AC [L-G] / [L-L] (MCOV)	230 V a.c. / 460 V a.c.	385 V a.c. / 770 V a.c.
Nominal discharge current (8x 20 μs) (I _n)	20 kA	20 kA
Max. discharge current (8/20) (I _{max})	50 kA	50 kA
Voltage protection rating [L-G] / [L-L] (VPR)	700 V _{pk} / 1500 V _{pk}	1200 V _{pk} / 2500 V _{pk}
Max. mains-side overcurrent protection	Not needed	Not needed
Approvals	UL, CSA	UL, CSA
Remote status contact	Floating (dry), Form C (SPDT)	Floating (dry), Form C (SPDT)



DEHNguard MU SPN ... 3W+G

DIN rail mount, pluggable surge arrester consisting of a base part and plug-in protection modules for application in Split Phase systems

Type DG MU ...	SPN 240 3W+G
Part No.	908 214
SPD classification acc. to ANSI/UL 1449 4 th Ed.	Open-Type 1 SPD
SPD classification acc. to CSA - C22.2 No. 269.1-14	Type 4-1 Component Assembly
Max. continuous operating voltage AC [L-N] / [L-G] / [L-L] / [N-G] (MCOV)	180 V a.c. / 360 V a.c. / 360 V a.c. / 180 V a.c.
Nominal discharge current (8x 20 μs) (I _n)	20 kA
Max. discharge current (8/20) (I _{max})	50 kA
Voltage protection rating [L-N] / [L-G] / [L-L] / [N-G] (VPR)	600 V _{pk} / 1200 V _{pk} / 1200 V _{pk} / 600 V _{pk}
Max. mains-side overcurrent protection	Not needed
Approvals	UL, CSA



DEHNguard MU SPN ... 3W+G R

DIN rail mount, pluggable surge arrester consisting of a base part and plug-in protection modules for application in 3 Split Phase systems; has floating Form C (SPDT) remote status contacts

Type DG ...	MU SPN 240 3W+G R
Part No.	908 219
SPD classification acc. to ANSI/UL 1449 4 th Ed.	Open-Type 1 SPD
SPD classification acc. to CSA - C22.2 No. 269.1-14	Type 4-1 Component Assembly
Max. continuous operating voltage AC [L-N] / [L-G] / [L-L] / [N-G] (MCOV)	180 V a.c. / 360 V a.c. / 360 V a.c. / 180 V a.c.
Nominal discharge current (8x 20 μs) (I _n)	20 kA
Max. discharge current (8/20) (I _{max})	50 kA
Voltage protection rating [L-N] / [L-G] / [L-L] / [N-G] (VPR)	600 V _{pk} / 1200 V _{pk} / 1200 V _{pk} / 600 V _{pk}
Max. mains-side overcurrent protection	Not needed
Approvals	UL, CSA
Remote status contact	Floating (dry), Form C (SPDT)



DEHNguard MU CGD ... 3W+G

DIN rail mount, pluggable surge arrester consisting of a base part and plug-in protection modules for application in Corner Grounded Delta systems

Type DG MU ...	CGD 240 3W+G	CGD 480 3W+G
Part No.	908 203	908 204
SPD classification acc. to ANSI/UL 1449 4 th Ed.	Open-Type 1 SPD	Open-Type 1 SPD
SPD classification acc. to CSA - C22.2 No. 269.1-14	Type 4-1 Component Assembly	Type 4-1 Component Assembly
Max. continuous operating voltage AC [L-G] / [L-L] (MCOV)	275 V a.c. / 550 V a.c.	550 V a.c. / 1100 V a.c.
Nominal discharge current (8x 20 μs) (I _n)	20 kA	20 kA
Max. discharge current (8/20) (I _{max})	50 kA	50 kA
Voltage protection rating [L-G] / [L-L] (VPR)	800 V _{pk} / 1500 V _{pk}	1800 V _{pk} / 3000 V _{pk}
Max. mains-side overcurrent protection	Not needed	Not needed
Approvals	UL, CSA	UL, CSA



DEHNgard MU CGD ... 3W+G R

DIN rail mount, pluggable surge arrester consisting of a base part and plug-in protection modules for application in Corner Grounded Delta systems; has floating Form C (SPDT) remote status contacts



Type DG MU ...	CGD 240 3W+G R	CGD 480 3W+G R
Part No.	908 208	908 209
SPD classification acc. to ANSI/UL 1449 4 th Ed.	Open-Type 1 SPD	Open-Type 1 SPD
SPD classification acc. to CSA - C22.2 No. 269.1-14	Type 4-1 Component Assembly	Type 4-1 Component Assembly
Max. continuous operating voltage AC [L-G] / [L-L] (MCOV)	275 V a.c. / 550 V a.c.	550 V a.c. / 1100 V a.c.
Nominal discharge current (8x 20 μs) (I _n)	20 kA	20 kA
Max. discharge current (8/20) (I _{max})	50 kA	50 kA
Voltage protection rating [L-G] / [L-L] (VPR)	800 V _{pk} / 1500 V _{pk}	1800 V / 3000 V
Max. mains-side overcurrent protection	Not needed	Not needed
Approvals	UL, CSA	UL, CSA
Remote status contact	Floating (dry), Form C (SPDT)	Floating (dry), Form C (SPDT)

DEHNgard SU 1P ...

DIN rail mount, pluggable surge arrester consisting of a base part and plug-in protection module for application in Single Phase electrical systems



Type DG SU ...	1P 120	1P 240	1P 347
Part No.	908 070	908 074	908 076
SPD classification acc. to ANSI/UL 1449 4 th Ed.	Open-Type 1 SPD	Open-Type 1 SPD	Open-Type 1 SPD
SPD classification acc. to CSA - C22.2 No. 269.1-14	Type 4-1 Component Assembly	Type 4-1 Component Assembly	Type 4-1 Component Assembly
Max. continuous operating voltage AC (MCOV)	230 Vac	385 Vac	510 Vac
Nominal discharge current (8x 20 μs) (I _n)	20 kA	20 kA	20 kA
Max. discharge current (8/20) (I _{max})	50 kA	50 kA	50 kA
Voltage protection rating (VPR)	700 V _{pk}	1200 V _{pk}	1500 V _{pk}
Max. mains-side overcurrent protection	Not needed	Not needed	Not needed
Approvals	UL, CSA	UL, CSA	UL, CSA

DEHNgard SU 1P ... R

DIN rail mount, pluggable surge arrester consisting of a base part and plug-in protection module for application in Single Phase electrical systems; has floating Form C (SPDT) remote status contacts



Type DG SU ...	1P 120 R	1P 240 R	1P 347 R
Part No.	908 090	908 094	908 096
SPD classification acc. to ANSI/UL 1449 4 th Ed.	Open-Type 1 SPD	Open-Type 1 SPD	Open-Type 1 SPD
SPD classification acc. to CSA - C22.2 No. 269.1-14	Type 4-1 Component Assembly	Type 4-1 Component Assembly	Type 4-1 Component Assembly
Max. continuous operating voltage AC (MCOV)	230 Vac	385 Vac	510 Vac
Nominal discharge current (8x 20 μs) (I _n)	20 kA	20 kA	20 kA
Max. discharge current (8/20) (I _{max})	50 kA	50 kA	50 kA
Voltage protection rating (VPR)	700 V _{pk}	1200 V _{pk}	1500 V _{pk}
Max. mains-side overcurrent protection	Not needed	Not needed	Not needed
Approvals	UL, CSA	UL, CSA	UL, CSA
Remote status contact	Floating (dry), Form C (SPDT)	Floating (dry), Form C (SPDT)	Floating (dry), Form C (SPDT)

Protection Module for DEHNgard M UL series

The varistor-based protection modules of the DEHNgard SU/MU ... surge arresters distinguish themselves through their outstanding performance and sophistication.

The compact protection modules incorporate the complete protective circuit as well as the monitoring and disconnection device. The green flag in the inspection window indicates the availability of the protection modules.

All protection modules are mechanically coded to guard against installing an incorrect module. The protection modules can be easily replaced without tools by simply pressing the user-friendly module release button.

- **High discharge capacity due to heavy-duty zinc oxide varistors (I_{max} 50 kA 8x20 μs)**
- **ANSI/UL 1449 – 4th Ed. Open-Type 1 SPD**
- **High reliability due to "Thermo Dynamic Control" SPD monitoring device**

DEHNgard PLU ...: Varistor-based protection module for DEHNgard SU/MU ... surge arresters

Varistor-Based Protection Module

Varistor-based protection module for DEHNgard MU ... and DEHNgard SU ... surge arresters.



Type DG PLU ...	180	230	275	385	510	550
Part No.	908 011	908 012	908 010	908 014	908 013	908 015
Nominal discharge current (8/20 μs) (I _n)	20 kA	20 kA	20 kA	20 kA	20 kA	20 kA
Max. discharge current (I _{max})	50 kA	50 kA	50 kA	50 kA	50 kA	50 kA



SPD+POP+MCB / POP+MCB

- Comprehensive protection against transient and power frequency overvoltage (SPD+POP)
- Fulfils the requirements of EN 50550 "Power frequency overvoltage protective device"
- Prewired complete unit, individual devices do not have to be additionally wired
- Easy installation and retrofitting thanks to low space requirements
- High reliability due to "Thermo Dynamic Control" monitoring system integrated in the SPD
- Application-optimised discharge capacity of 5 kA (I_n) / 15 kA (I_{max}) (8/20 μ s) per pole
- Energy coordination with other arresters of the Red/Line series
- Operating state / fault indication by green / red indicator flag in the inspection window of the SPD



For protecting low-voltage consumer's installations against transient and temporary overvoltages (SPD+POP). For installation in conformity with the lightning protection zone concept at the boundaries from $0_B - 1$ and higher.

SPD+POP 2 255 C... : Compact surge arrester for transient and power frequency overvoltages in single-phase TT and TN systems (1+1 configuration)

SPD+POP 4 255 C... : Compact surge arrester for transient and power frequency overvoltages in TT and TN systems (3+1 configuration)

POP 2 255 C... : Compact surge protective device for power frequency overvoltages in single-phase TT and TN systems

POP 4 255 C... : Compact surge protective device for power frequency overvoltages in single-phase TT and TN-S systems

Electrical installations are increasingly damaged by overvoltage. This damage is not only caused by transient overvoltages, but also by power frequency overvoltages which result from, e.g. instable systems or breakage of the neutral conductor.

The compact SPD+POP 2/4 255 C.. surge protective devices combine conventional surge protection (SPD) with power frequency overvoltage protection (POP) in an easy-to-install complete device.

The type 2 arresters ensure protection against transient overvoltages caused by, e.g. inductive coupling resulting from a lightning strike or switching operations. The devices fully comply with the requirements of national and international product standards and feature a dual "Thermo Dynamic Control" monitoring device which ensures maximum reliability.

The POP 2/4 255 C.. surge protective devices can be used in installations which are already protected against transient overvoltage by other meas-

ures and comply with the European EN 50550 product standard for "Power frequency overvoltage protective devices".

If power frequency overvoltages occur, the connected miniature circuit breaker (MCB) disconnects the arresters, putting them into a safe state. When the miniature circuit breaker is reconnected, the system is checked for surges. If the system is still unstable and unbalanced surges are present, the miniature circuit breaker trips again.

Various types are available for different tripping currents of the miniature circuit breaker. This ensures that the surge protective device is suitable for the parameters of the electrical installation.

Despite of the manifold functions, the devices take up little space: Four to seven modules are required for protecting an electrical installation. Therefore, the devices can be easily retrofitted into existing electrical installations.

Two-pole SPD+POP+MCB



Type SPD+POP ...	2 255 C25	2 255 C32	2 255 C40
Part No.	900 780	900 781	900 782
SPD+POP+MCB			
Number of poles	1P + N	1P + N	1P + N
Nominal a.c. voltage (U _N)	230 V	230 V	230 V
SPD			
Nominal discharge current (8/20 μs) [L-N] (I _n)	5 kA	5 kA	5 kA
MCB			
Tripping characteristic	C	C	C
Nominal alternating current (I _n)	25 A	32 A	40 A

Four-pole SPD+POP+MCB



Type SPD+POP ...	4 255 C25	4 255 C32	4 255 C40	4 255 C63
Part No.	900 785	900 786	900 787	900 788
SPD+POP+MCB				
Number of poles	3P + N	3P + N	3P + N	3P + N
Nominal a.c. voltage (U _N)	230 / 400 V	230 / 400 V	230 / 400 V	230 / 400 V
SPD				
Nominal discharge current (8/20) [L-N] (I _n)	5 kA	5 kA	5 kA	5 kA
MCB				
Tripping characteristic	C	C	C	C
Nominal alternating current (I _n)	25 A	32 A	40 A	63 A

Two-pole POP+MCB



Type POP ...	2 255 C25	2 255 C32	2 255 C40
Part No.	900 760	900 761	900 762
POP+MCB			
Number of poles	1P + N	1P + N	1P + N
Nominal a.c. voltage (U _N)	230 V	230 V	230 V
MCB			
Tripping characteristic	C	C	C
Nominal alternating current (I _n)	25 A	32 A	40 A

Four-pole POP+MCB



Type POP ...	4 255 C25	4 255 C32	4 255 C40	4 255 C63
Part No.	900 765	900 766	900 767	900 768
POP+MCB				
Number of poles	3P + N	3P + N	3P + N	3P + N
Nominal a.c. voltage (U _N)	230 / 400 V	230 / 400 V	230 / 400 V	230 / 400 V
MCB				
Tripping characteristic	C	C	C	C
Nominal alternating current (I _n)	25 A	32 A	40 A	63 A



DEHNcord

- Single-pole, two-pole or three-pole surge protective device with monitoring system and disconnector
- Visual fault indication
- Types with disconnection of the load circuit in the event of a fault and protection of the control phase
- Compact design also for outdoor use
- Can be fitted in junction boxes, flush-mounted systems, cable ducts and flush-type boxes



For protecting electronic devices (e.g. LED lights, smart poles, wall boxes or technical building equipment) from surges. For flexible installation in electrical installation systems such as flush-type boxes. Due to its compact design, the arrester can always be installed in the right place in the relevant installation area. For installation in conformity with the lightning protection zone concept at the boundaries from $0_B - 1$ and higher.

- DEHNcord L 1P ...:** Compact single-pole version; e.g. for use in luminaires of protection class 1
- DEHNcord L 2P ...:** Compact two-pole version; e.g. for use in luminaires of protection class 2 or in flush-type boxes, flush-mounted systems and cable ducts
- DEHNcord L 3P ... SO LTG:** Compact three-pole version; for use in the junction boxes of LED light poles with disconnection of the load circuit in the event of a fault and for protecting the control phase
- SK EK480 G2S-2d LM DCOR:** EK480 fuse box with integrated DEHNcord L 3P 275 SO LTG surge protective device (Part No. 900 445)
- DEHNcord R 3P ...:** Compact three-pole version; for use with electric sun shading systems
- DEHNcord 3P ...:** Compact three-phase version; for use in confined spaces, e.g. in a wall box

The DEHNcord series can be used flexibly as a type 2 surge arrester, thus offering a variety of different application options. The surge arresters are ideally suited for protecting electrical and electronic consumers wherever the performance of a standard type 3 surge protective device for terminal equipment reaches its limits. The new three-phase DEHNcord is ideally suited for applications in wall boxes, smart poles and in building technology. Due to its extremely compact design, the device can be used in confined spaces. In addition, universal installation is possible without additional installation material. The push-in double terminals ensure fast wiring.

Another important field of application is the protection of outdoor LED lights. The DEHNcord L ... SO LTG version is particularly suitable for this purpose and can be integrated in the junction box of an LED light pole. This version additionally allows a control phase to be protected and the load circuit to be interrupted if the DEHNcord arrester is faulty. This makes it considerably easier to detect faults, thus facilitating testing and maintenance of the system. Despite the powerful protective circuit, the compact enclosure also houses a disconnector and a visual operating state / fault indicator. DEHNcord is a type 2 surge arrester and can therefore be installed according to the lightning protection zones concept at the transition from $0_B - 1$ and higher. This ensures installation of surge protective devices in line with the standard wherever space is restricted.

The IP type can both be integrated in junction boxes and directly in the pole (cables can be entered into any junction box thanks to IP 65 degree of protection).



LED lights are optimally protected against surges by the DEHNcord series. The LTG version is ideally suited for integration in fuse boxes. Thanks to its adapted design, the device fits perfectly into the upper area of the EK480 junction box from Langmatz.

If no junction box is installed in the LED light, the EK480 fuse box with integrated DEHNcord surge protective device can be used as a complete solution. The innovative plug-in technology allows the wires to be connected to the luminaire without tools, and the system can be installed more quickly. Should it become necessary, the surge protective device can be easily replaced at any time.

The multipole DEHNcord R 3P adapter is a type 2 surge arrester. It protects sun shading systems and Venetian blinds and is installed in the connecting cables of the drive. In addition, this version can also be used to protect buildings against surges induced on the building facade. DEHNcord R 3P meets the requirements of the lightning protection zone concept as well as the installation standard for buildings IEC 60364-4-44/-5-53.

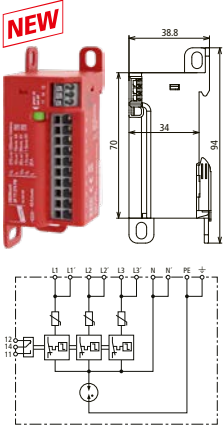

DEHNcord 3P TT 275 FM

Compact three-phase arrester for for TT and TN-S systems.

Type	DCOR 3P TT 275 FM
Part No.	900 439 ^{NEW}
SPD according to EN 61643-11 / IEC 61643-11	type 2 + type 3 / class II + class III
Max. continuous operating voltage (a.c.) [L-N] (U_c)	275 V (50 / 60 Hz)
Max. continuous operating voltage (d.c.) (U_c)	350 V
Nominal discharge current (a.c.) / (d.c.) (I_n)	25 A
Nominal discharge current (8/20 μ s) (I_n)	10 kA
Max. discharge current (8/20 μ s) (I_{max})	20 kA
Combination wave wave [L-N]/[N-PE] (U_{oc})	20 kA
Voltage protection level [L-N] (U_p)	≤ 1.5 kV
Voltage protection level [N-PE] (U_p)	≤ 1.5 kV

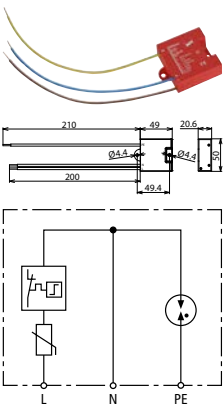

DEHNcord L 2P

Two-pole surge arrester for all installation systems (1+1 configuration) and luminaires of protective class I; compact design.

Type	DCOR L 2P 275	DCOR L 2P 320
Part No.	900 430	900 432
SPD according to EN 61643-11 / IEC 61643-11	type 2 / class II	type 2 / class II
Max. continuous operating voltage (a.c.) [L-N] (U_c)	275 V (50 / 60 Hz)	320 V (50 / 60 Hz)
Nominal discharge current (8/20 μ s) (I_n)	5 kA	5 kA
Max. discharge current (8/20 μ s) (I_{max})	10 kA	10 kA
Voltage protection level [L-N] (U_p)	≤ 1.5 kV	≤ 1.75 kV
Voltage protection level [N-PE] (U_p)	≤ 1.5 kV	≤ 1.5 kV
Max. mains-side overcurrent protection	25 A gG	25 A gG
Approvals	KEMA	KEMA

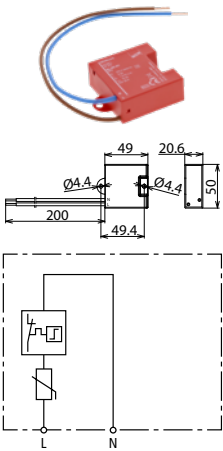

DEHNcord L 1P

Single-pole surge arrester for luminaires of protection class II; compact design.

Type	DCOR L 1P 275	DCOR L 1P 320
Part No.	900 431	900 433
SPD according to EN 61643-11 / IEC 61643-11	type 2 / class II	type 2 / class II
Max. continuous operating voltage (a.c.) [L-N] (U_c)	275 V (50 / 60 Hz)	320 V (50 / 60 Hz)
Nominal discharge current (8/20 μ s) (I_n)	5 kA	5 kA
Max. discharge current (8/20 μ s) (I_{max})	10 kA	10 kA
Voltage protection level [L-N] (U_p)	≤ 1.5 kV	≤ 1.75 kV
Max. mains-side overcurrent protection	25 A gG	25 A gG
Approvals	KEMA	KEMA

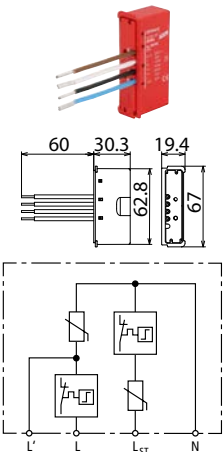

DEHNcord L 2P SN1864

Surge arrester for luminaires of protection class II; compact design. With disconnection in the event of a fault.

Type	DCOR L 2P SN1864
Part No.	999 906
SPD according to EN 61643-11 / IEC 61643-11	type 2 / class II
Max. continuous operating voltage (a.c.) [L-N] (U_c)	275 V (50 / 60 Hz)
Nominal discharge current (8/20 μ s) (I_n)	5 kA
Max. discharge current (8/20 μ s) (I_{max})	10 kA
Voltage protection level [L-N] (U_p)	≤ 1.5 kV
Max. mains-side overcurrent protection	B 16 A

Surge Arresters – Type 2

DEHNcord L 2P SN1860

Surge arrester for all installation systems; compact design. With disconnection of the load circuit in the event of a fault.

Type	DCOR L 2P SN1860
Part No.	999 937
SPD according to EN 61643-11 / IEC 61643-11	type 2 / class II
Max. continuous operating voltage (a.c.) [L-N] (U_c)	275 V (50 / 60 Hz)
Nominal discharge current (8/20 μ s) (I_n)	5 kA
Max. discharge current (8/20 μ s) (I_{max})	10 kA
Voltage protection level [L-N] (U_p)	≤ 1.5 kV
Voltage protection level [N-PE] (U_p)	≤ 1.5 kV
Max. mains-side overcurrent protection	B 16 A

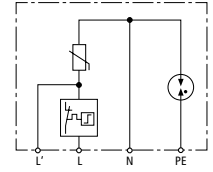
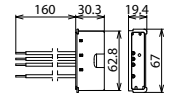
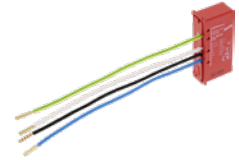

DEHNcord L 2P 275 SO LTG

Surge arrester for all installation systems; compact design. With disconnection of the load circuit in the event of a fault.

Type	DCOR L 2P 275 SO LTG
Part No.	900 446
SPD according to EN 61643-11 / IEC 61643-11	type 2 / class II
Max. continuous operating voltage (a.c.) [L-N] (U_c)	275 V (50 / 60 Hz)
Nominal discharge current (8/20 μ s) (I_n)	5 kA
Max. discharge current (8/20 μ s) (I_{max})	10 kA
Voltage protection level [L-N] (U_p)	≤ 1.5 kV
Voltage protection level [N-PE] (U_p)	≤ 1.5 kV
Max. mains-side overcurrent protection	B 16 A
Approvals	KEMA

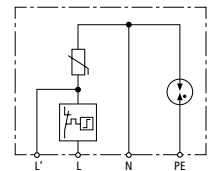
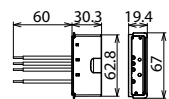
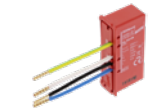

DEHNcord L 3P 275 SO LTG

Three-pole surge arrester for all installation systems; compact design. With disconnection of the load circuit in the event of a fault and protection of the control phase.

Type	DCOR L 3P 275 SO LTG
Part No.	900 445
SPD according to EN 61643-11 / IEC 61643-11	type 2 / class II
Max. continuous operating voltage (a.c.) [L-N] (U_c)	275 V (50 / 60 Hz)
Nominal discharge current (8/20 μ s) (I_n)	5 kA
Max. discharge current (8/20 μ s) (I_{max})	10 kA
Voltage protection level [L-N] (U_p)	≤ 1.5 kV
Voltage protection level [N-PE] (U_p)	≤ 1.5 kV
Max. mains-side overcurrent protection	B 16 A
Approvals	KEMA

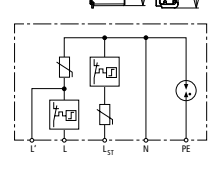
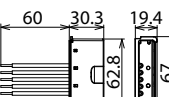
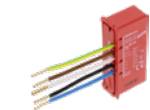

SK EK480 G2S-2d LM DCOR

The EK480 fuse box is a high-quality product from Langmatz which stands out for its excellent workmanship and tried and tested features. The EK480 series meets all mechanical and electrical requirements and standards. This ensures the effective protection of luminaires with high-quality electronics against surges resulting from switching operations or nearby lightning strikes.

Type	SK EK480 G2S-2d LM DCOR
Part No.	900 443 ^{NEW}
Data of fuse box	
Dimensions	276 x 81 x 70 mm
For masts with an inside diameter from	89 mm
Clamping technology	incoming: sliding clamp technology / outgoing: spring clamp technology
Max. cross-section of connectable cable	1 - 3 cables (4 or 5 x 16 mm ²)
Outgoing terminals	max. 2.5 mm ²
Data of DEHNcord L 3P 275 SO LTG surge protective device	
SPD according to EN 61643-11 / IEC 61643-11	type 2 / class II
Max. continuous operating a.c. voltage [L-N] (U_c)	275 V (50 / 60 Hz)
Nominal discharge current (8/20 μ s) (I_n)	5 kA
Max. discharge current (8/20 μ s) (I_{max})	10 kA
Voltage protection level [L-N] (U_p)	≤ 1.5 kV
Voltage protection level [N-PE] (U_p)	≤ 1.5 kV
Max. mains-side overcurrent protection	B 16 A



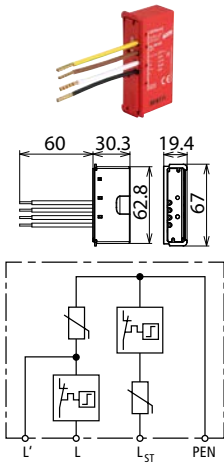

DEHNcord L 2P 275 SO LT

Two-pole surge arrester for TNC systems; compact design. With disconnection of the load circuit in the event of a fault and protection of the control phase.

Type	DCOR L 2P 275 SO LT
Part No.	900 435
SPD according to EN 61643-11 / IEC 61643-11	type 2 / class II
Max. continuous operating voltage (a.c.) [L-PEN] (U_c)	275 V (50 / 60 Hz)
Nominal discharge current (8/20 μ s) (I_n)	5 kA
Max. discharge current (8/20 μ s) (I_{max})	10 kA
Voltage protection level [L-PEN] (U_p)	≤ 1.5 kV
Max. mains-side overcurrent protection	B 16 A
Approvals	KEMA

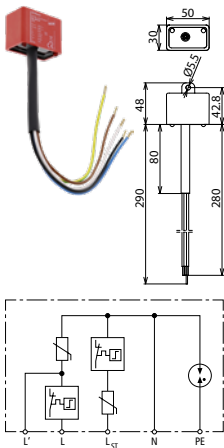

DEHNcord L 3P 275 SO IP

Three-pole surge arrester for all installation systems; compact design. IP 65 degree of protection. With disconnection of the load circuit in the event of a fault and protection of the control phase.

Type	DCOR L 3P 275 SO IP
Part No.	900 447
SPD according to EN 61643-11 / IEC 61643-11	type 2 / class II
Max. continuous operating voltage (a.c.) [L-N] (U_c)	275 V (50 / 60 Hz)
Nominal discharge current (8/20 μ s) (I_n)	5 kA
Max. discharge current (8/20 μ s) (I_{max})	10 kA
Voltage protection level [L-N] (U_p)	≤ 1.5 kV
Voltage protection level [N-PE] (U_p)	≤ 1.5 kV
Max. mains-side overcurrent protection	B 16 A

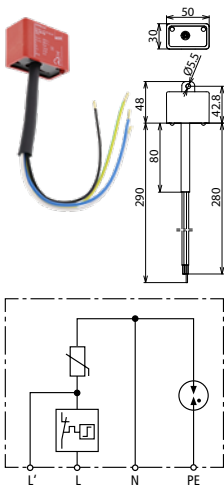

DEHNcord L 2P 275 SO IP

Two-pole arrester for all installation systems; compact design. IP 65 degree of protection. With disconnection of the load circuit in the event of a fault.

Type	DCOR L 2P 275 SO IP
Part No.	900 448
SPD according to EN 61643-11 / IEC 61643-11	type 2 / class II
Max. continuous operating voltage (a.c.) [L-N] (U_c)	275 V (50 / 60 Hz)
Nominal discharge current (8/20 μ s) (I_n)	5 kA
Max. discharge current (8/20 μ s) (I_{max})	10 kA
Voltage protection level [L-N] (U_p)	≤ 1.5 kV
Voltage protection level [N-PE] (U_p)	≤ 1.5 kV
Max. mains-side overcurrent protection	B 16 A

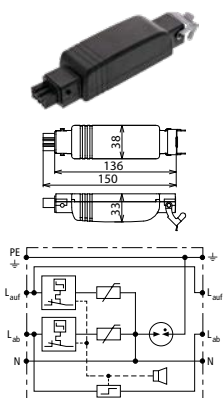

DEHNcord R 3P

Surge arrester for electric Venetian blinds; compact design.

Type	DCOR R 3P 275
Part No.	900 449
SPD according to EN 61643-11 / IEC 61643-11	type 2 / class II
Max. continuous operating voltage (a.c.) [L-N] (U_c)	275 V (50 / 60 Hz)
Nominal discharge current (8/20 μ s) (I_n)	2.5 kA
Max. discharge current (8/20 μ s) (I_{max})	5 kA
Voltage protection level [L-N] (U_p)	≤ 1.5 kV
Connector	Hirschmann STAK 3 / STAS 3



DEHNgap C S

N-PE surge arrester

- Specifically designed for use in 3+1 and 1+1 configurations of TT systems acc. to IEC 60364-5-53 between neutral conductor N and protective conductor PE
- High discharge capacity
- Two-part surge arrester consisting of a base part and a plug-gap-based protection module
- Energy coordination with other arresters of the Red/Line product family
- Operating state / fault indication by green / red indicator flag in the inspection window
- With remote signalling contact for monitoring device
- Easy replacement of protection modules without tools due to module locking system with module release button
- Vibration and shock-tested according to EN 60068-2



For protecting low-voltage consumer installations against surges. For installation in conformity with the lightning protection zone concept at the boundaries from $O_B - 1$ and higher.

DEHNgap C S: N-PE surge arrester consisting of a base part and a plug-in protection module

DEHNgap C S FM: With remote signalling contact for monitoring device (floating changeover contact)

The N-PE surge arrester DEHNgap C S is the ideal supplement to the DEHNgard S single-pole surge protective devices. As a total current arrester between the neutral and protective conductor in TT systems, it has the task of ensuring the requirements for the protection of people and property in the so-called 3+1 or 1+1 configurations.

With their modern Red/Line design, DEHNgap C S surge arresters have exactly the same easy-to-use safety features as the DEHNgard S devices. The unique module locking system combines the spark-gap-based protection module and the base part to form a powerful unit. Neither vibration during transport nor the enormous forces of discharge can loosen this connection. Nevertheless, the protection modules can be easily replaced without tools by simply pressing the easy-to-use module release button of the protection module. The mechanical coding of the protection module and base part guards against installing an incorrect module.

Safety of DEHNgap C S surge arresters is increased by monitoring the arrester temperature and an integrated disconnecter connected in series with the surge arrester.

The green and red indicator flags show the operating state of DEHNgap C S surge arresters.

Apart from this standard visual indication, DEHNgap C S ... FM features a three-pole remote signalling terminal. As the remote signalling contact is designed as a floating changeover contact, the remote signal can, depending on the circuit concept, be used as a make or break contact. The N-PE surge arresters of type DEHNgap C S incorporate multifunctional terminals for connecting conductors and busbars, allowing easy wiring with other DIN rail mounted devices. Thus, a variety of applications can be easily connected in series according to IEC 60364-5-53 for optimal protection.

DEHNgap C S (FM)

N-PE surge arrester; FM version with floating remote signalling contact.

Type DGP C ...	S	S FM
Part No.	952 030	952 035
SPD according to EN 61643-11 / IEC 61643-11	type 2 / class II	type 2 / class II
Max. continuous operating voltage (a.c.) (U_c)	255 V (50 / 60 Hz)	255 V (50 / 60 Hz)
Nominal discharge current (8/20 μ s) (I_n)	20 kA	20 kA
Max. discharge current (8/20 μ s) (I_{max})	40 kA	40 kA
Voltage protection level (U_p)	≤ 1.5 kV	≤ 1.5 kV
Approvals	KEMA, VDE, UL	KEMA, VDE, UL
Type of remote signalling contact	—	changeover contact



Accessories for DEHNgap C S

N-PE Spark-Gap-Based Protection Module for DEHNgap C S

N-PE spark-gap-based protection module for single-pole N-PE surge arresters of type DEHNgap DGP C S ...

Type	DGP C MOD
Part No.	952 060
Max. continuous operating voltage (a.c.) (U_c)	255 V



DEHNguard ME/SE DC ... (FM)



For protecting low-voltage consumer's installations against surges. For installation in conformity with the lightning protection zone concept at the boundaries from $O_B - 1$ and higher.

- Universal combined arrester / surge arrester consisting of a base part and a plug-in protection module
- Device concept specifically developed for use in d.c. circuits
- Powerful d.c. switching device DCD prevents fire damage caused by d.c. switching arcs
- Use without additional backup fuse in defined applications
- Operating state / fault indication by green / red indicator flag in the inspection window
- Easy replacement of protection modules without tools due to module locking system with module release button

DEHNguard ME DC ... FM: Multipole combined arrester for d.c. applications up to 950 V

DEHNguard SE DC ...: Modular single-pole surge arrester for d.c. applications

DEHNguard SE DC ... FM: With remote signalling contact for monitoring device (floating changeover contact)

The modular devices of the DEHNguard SE DC product series are coordinated single-pole type 2 surge arresters with a functional design.

When developing this device series for protecting d.c. systems, the main focus was on the increased requirements of d.c. applications with regard to device safety in all operating states. The extremely powerful d.c. switching device DCD, which prevents fire damage caused by switching arcs, is the core of the DEHNguard SE DC devices.

DEHNguard SE DC ... (FM) is coordinated with the corresponding type 1 DEHNsecure ... (FM) lightning current arrester for the respective voltage.

The DEHNguard SE DC devices combine high performance and ease of use in a single device. Their electrical parameters are rated for the most stringent requirements within lightning and surge protection systems. The high number of features shows that the main focus is both on reliable surge protection and device safety.

Proven heavy-duty varistors are used to discharge high impulse currents and limit the destructive surge impulses to the specified voltage protection level values. The operating state of the arrester is permanently monitored via the surface temperature of the heavy-duty varistor and the d.c. switching device DCD is immediately activated in case of overload. The mechanical visual indicator with green and red indicator flags, which is available for each protective path, is directly connected to the d.c. switching device DCD. When the red indication appears in the inspection window, the d.c. switching device DCD has already safely interrupted the d.c. switching arc and thus reliably prevented fire damage. In case of the

DEHNguard SE DC ... FM version, the arrester status is additionally reported via a three-pole remote signalling terminal.

The special design of the d.c. switching device DCD even ensures a short-circuit withstand capability up to 300 A d.c. – without arrester back-up fuse (!). In combination with the specified backup fuses, the short-circuit withstand capability can be even increased to 25,000 A d.c., which is certainly an innovation in the field of d.c. applications.

The single-pole devices are available for voltages from 60 V to 900 V d.c. and thus DEHNguard SE DC type 2 surge arresters can be used for a variety of applications such as emergency power supply systems, d.c. systems for direct supply of d.c. drives, control circuits and battery-operated supply systems of any kind.

To implement these numerous features, the devices incorporate the modular Red/Line family design with a width of 1.5 modules. The mechanical design of the connection points is another safety feature. The covered screws provide additional touch protection and the projections for easily and safely entering the cable increase clearances and creepage distances so that no distance to other equipment must be maintained even in case of voltages up to 900 V d.c.

The coded plug-in protection modules ensure a high degree of protection. Consequently, damage caused by installing an incorrect module can be virtually excluded.

The universal T1 + T2 combined arrester is specially designed for use with direct current sources up to 950 V.

DEHNguard ME DC ... FM

Modular combined arrester for DC applications; with floating remote signalling contact.

NEW



Type DG ...	ME DC Y 950 FM
Part No.	972 146 ^{NEW}
SPD analogous to EN 61643-11 / IEC 61643-11	type 1 + type 2 / class I + class II
Max. continuous operating voltage (d.c.) (U_c)	950 V
Lightning impulse current (10/350 μ s) (I_{imp})	5 kA
Nominal discharge current (8/20 μ s) (I_n)	12.5 kA
Voltage protection level [DC+ -> DC-] (U_p)	≤ 4 kV
Voltage protection level [(DC+/DC-) -> PE] (U_p)	≤ 3.2 kV
Max. short circuit withstand capability (I_{sccr})	500 A / 170 ms
Approvals	UL
Type of remote signalling contact	changeover contact

Surge Arresters – Type 2

DEHNgard SE DC ...

Modular single-pole surge arrester for d.c. applications.

Type DG ...	SE DC 60	SE DC 242	SE DC 550	SE DC 900
Part No.	972 110	972 120	972 130	972 140
SPD according to EN 61643-11 / IEC 61643-11	type 2 / class II	type 2 / class II	type 2 / class II	type 2 / class II
Max. continuous operating voltage (d.c.) (U_c)	60 V	242 V	550 V	900 V
Nominal discharge current (8/20 μ s) (I_n)	12.5 kA	12.5 kA	12.5 kA	12.5 kA
Voltage protection level (U_p)	≤ 0.5 kV	≤ 1.25 kV	≤ 2.0 kV	≤ 3.0 kV
Short-circuit withstand capability without backup fuse (d.c.) (I_{SCCR})	300 A	300 A	200 A	100 A
Short-circuit withstand capability for max. mains-side overcurrent protection (d.c.) (I_{SCCR})	25 kA	25 kA	25 kA	25 kA
Max. mains-side overcurrent protection	35 A gG	35 A gG	35 A gG	80 A gPV



DEHNgard SE DC ... FM

Modular single-pole surge arrester for d.c. applications; with floating remote signalling contact.

Type DG ...	SE DC 60 FM	SE DC 242 FM	SE DC 550 FM	SE DC 900 FM
Part No.	972 115	972 125	972 135	972 145
SPD according to EN 61643-11 / IEC 61643-11	type 2 / class II	type 2 / class II	type 2 / class II	type 2 / class II
Max. continuous operating voltage (d.c.) (U_c)	60 V	242 V	550 V	900 V
Nominal discharge current (8/20 μ s) (I_n)	12.5 kA	12.5 kA	12.5 kA	12.5 kA
Voltage protection level (U_p)	≤ 0.5 kV	≤ 1.25 kV	≤ 2.0 kV	≤ 3.0 kV
Short-circuit withstand capability without backup fuse (d.c.) (I_{SCCR})	300 A	300 A	200 A	100 A
Short-circuit withstand capability for max. mains-side overcurrent protection (d.c.) (I_{SCCR})	25 kA	25 kA	25 kA	25 kA
Max. mains-side overcurrent protection	35 A gG	35 A gG	35 A gG	80 A gPV
Type of remote signalling contact	changeover contact	changeover contact	changeover contact	changeover contact



Accessories for DEHNgard ME / SE DC ... (FM)

Varistor-Based Protection Module for DEHNgard ME DC

Type	DG MOD DC Y 500
Part No.	972 050 ^{NEW}
Max. continuous operating voltage (d.c.) (U_c)	950 V



Spark-Gap Based Protection Module for DEHNgard ME DC

Type	DGP MOD DC Y 500
Part No.	972 051 ^{NEW}
Max. continuous operating voltage DC (U_c)	950 V



Varistor-Based Protection Module for DEHNgard SE DC

Type DG MOD ...	E DC 60	E DC 242	E DC 550	E DC 900
Part No.	972 010	972 020	972 030	972 040
Max. continuous operating voltage (d.c.) (U_c)	60 V	242 V	550 V	900 V



Earthing Clip for 1.5-module Enclosures, single-phase, two-pole

Earthing clip for connecting the earth terminal of e.g. two SPDs with 1.5-module enclosure to earth, with terminal.

Type	EB 1 2 1.5
Part No.	900 460
Dimensions	34 x 60 x 28 mm
Terminal	up to 25 mm ²





DEHNgard modular YPV ... FM

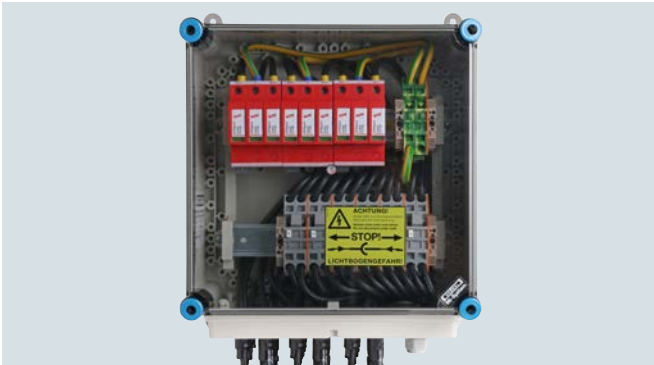

For protecting low-voltage consumer installations against surges. For use in accordance with IEC 60364-7-712 [photovoltaic (PV) power systems].

Multipole photovoltaic arresters

- Prewired complete unit for photovoltaic systems consisting of a base part and plug-in protection modules
- Fault-resistant Y circuit with three heavy-duty varistors prevents damage to the surge protective device in case of insulation faults in the generator circuit
- Tested to EN 50539-11
- High reliability due to "Thermo Dynamic Control" disconnecter
- Fault indication by red indicator flag in the inspection window
- Suitable for use in accordance with IEC 60364-7-712 [Photovoltaic (PV) power systems]

DEHNgard M YPV 1200 FM: For PV systems up to 1170 V, with remote signalling contact for monitoring device (floating changeover contact)

DEHNgard M YPV 1500 FM: For PV systems up to 1500 V, with remote signalling contact for monitoring device (floating changeover contact)

The modular DEHNgard modular YPV SCI ... FM surge arresters are specifically designed for protecting equipment in photovoltaic systems. The devices are available for 1200 V and 1500 V and cover the most common voltage levels.

The following application features distinguish the modular arrester design of this Red/Line product series. The module locking system firmly fixes the protection modules to the base part. Neither shock nor vibration nor the enormous forces of discharge affect the safe connection to the protection module. Nevertheless, the protection modules can be easily replaced without tools by simply pressing the easy-to-use module release button of the protection modules. Every protective path of DEHNgard modular YPV SCI ... FM and every protection module is mechanically coded to guard against installing the incorrect module.

The fault-resistant Y circuit with three heavy-duty varistors prevents damage to surge protective devices in case of insulation faults in the generator circuit of the photovoltaic generator.

The green and red indicator flags show the availability of every protective circuit. Apart from this visual indication, DEHNgard YPV ... FM arresters also feature a three-pole remote signalling terminal. As the remote signalling contact is designed as a floating changeover contact, the remote signal can, depending on the circuit concept, be used as a make or break contact. As with all surge arresters of the modular DEHNgard modular family, DEHNgard modular YPV ... FM arresters incorporate multifunctional terminals on a standardised spacing of 1 module for connecting conductors and busbars, allowing easy wiring with other DIN rail mounted devices.

DEHNgard M YPV ... FM

Modular multipole surge arrester for PV systems with remote signalling contact for monitoring device (floating changeover contact).



Type DG M YPV ...	1200 FM	1500 FM
Part No.	952 565	952 567
SPD according to EN 50539-11	type 2	type 2
Max. PV voltage (U_{CPV})	1170 V	1500 V
Short-circuit current rating (I_{SCP})	10 kA	10 kA
Nominal discharge current (8/20 μ s) [(DC+/DC-) --> PE] (I_n)	20 kA	15 kA
Max. discharge current (8/20 μ s) [(DC+/DC-) --> PE] (I_{max})	40 kA	40 kA
Voltage protection level (U_p)	≤ 4 kV	≤ 5 kV
Approvals	UL, KEMA	UL, KEMA
Type of remote signalling contact	changeover contact	changeover contact

Accessories for DEHNgard modular YPV ... FM



Varistor-Based Protection Module for DEHNgard M YPV

Type	DG MOD H PV 600	DG MOD H PV 750
Part No.	952 048	952 049
Max. continuous operating voltage (d.c.) (U_C)	600 V	750 V

DEHNguard modular (Y)PV SCI ...

Multipole/single-pole PV arresters with three-step d.c. switching device

- Prewired modular complete unit for use in photovoltaic systems consisting of a base part and plug-in protection modules
- Combined disconnection and short-circuiting device with safe electrical isolation in the protection module (patented SCI principle)
- Tried and tested fault-resistant Y circuit of DEHNguard M YPV SCI ... (FM) prevents damage to the surge protective device in case of insulation faults in the generator circuit
- Tested to EN 50539-11
- Suitable for use in all PV systems according to IEC 60364-7-712



For protecting low-voltage consumer installations against surges. For use in accordance with IEC 60364-7-712 (photovoltaic (PV) power systems).

DEHNguard M YPV SCI 150:	Modular multipole surge arrester with three-step d.c. switching device; for photovoltaic systems up to 150 V
DEHNguard M YPV SCI 600:	For photovoltaic systems up to 600 V
DEHNguard M YPV SCI 1000:	For photovoltaic systems up to 1000 V
DEHNguard M PV2 SCI 1000:	For photovoltaic systems up to 1000 V; for protecting two MPP inputs
DEHNguard M YPV SCI 1200:	For photovoltaic systems up to 1200 V
DEHNguard M YPV SCI ... FM:	With remote signalling contact for monitoring device (floating changeover contact)
DEHNguard S PV SCI 150:	For photovoltaic systems up to 150 V solidly earthed on the d.c. side
DEHNguard S PV SCI 600:	For photovoltaic systems up to 600 V solidly earthed on the d.c. side
DEHNguard S PV SCI ... FM:	With remote signalling contact for monitoring device (floating changeover contact)

The modular DEHNguard modular (Y)PV SCI ... (FM) surge arresters are specifically designed for protecting equipment in photovoltaic systems. The patented three-step d.c. switching device (SCI principle) makes these arresters especially safe so that they fulfil the requirements in modern photovoltaic systems. The devices are available for 150 V, 600 V, 1000 V and 1200 V applications. DEHNguard ME YPV SCI 1500 (FM) – a 1500 V version – covers the most common voltage levels. DEHNguard M PV2 SCI ... also provides protection for 2 MPP inputs in a single device.

The application features of the modular Red/Line family design are as unique as the three-step d.c. switching device. The module locking system firmly fixes the protection modules to the base part. Neither shock nor vibration nor the enormous forces of discharge affect the safe connection to the protection module. Nevertheless, the protection modules can be easily replaced without tools by simply pressing the easy-to-use module release button of the protection modules. Every protective path of DEHNguard modular (Y)PV SCI ... (FM) and every protection module is mechanically coded to guard against installing the incorrect module.

To fulfil the special requirements in photovoltaic systems, a fault-resistant Y circuit consisting of three protective paths of the varistor and a combined disconnection and short-circuiting device are integrated in a single device.

This synergy reduces the probability of an arrester failure in case of the operating and fault states which have to be considered in photovoltaic systems. This ensures that the arrester is protected in case of overload. Even in case of voltages up to 1200 V d.c., a switching arc, which is likely to occur in the surge protective device if a conventional disconnecter (for a.c. applications) is activated, is extinguished immediately without risk.

DG S PV SCI ... (FM) arresters are specifically designed for PV systems solidly earthed on the d.c. side. Since either the positive or the negative pole of the PV generator is solidly earthed, the space-saving and thus cost-effective DG S PV SCI ... (FM) arresters can be used where one protection module has been removed from the Y circuit.

The green and red indicator flags show the availability of every protective circuit. Apart from this visual indication, DEHNguard (Y)PV SCI ... (FM) arresters also feature a three-pole remote signalling terminal. As the remote signalling contact is designed as a floating changeover contact, the remote signal can, depending on the circuit concept, be used as a make or break contact. As with all surge arresters of the modular DEHNguard modular family, DEHNguard modular (Y)PV SCI ... (FM) arresters incorporate multifunctional terminals on a standardised spacing of 1 module for connecting conductors and busbars, allowing easy wiring with other DIN rail mounted devices.

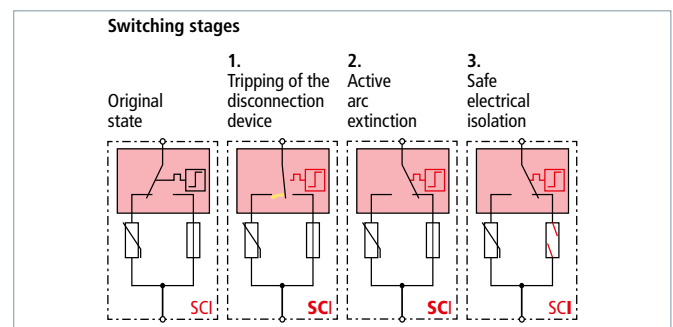

Three-step d.c. switching device (patented SCI principle)

DEHNgard M YPV SCI ...

Modular multipole surge arrester with three-step d.c. switching device for use in PV systems



Type DG ...	M YPV SCI 150	M YPV SCI 600	M YPV SCI 1000	M YPV SCI 1200
Part No.	952 513	952 511	952 510	952 512
SPD according to EN 50539-11	type 2	type 2	type 2	type 2
Max. PV voltage (U_{CPV})	150 V	600 V	1000 V	1200 V
Short-circuit current rating (I_{SCPV})	10 kA	10 kA	10 kA	10 kA
Nominal discharge current (8/20 μ s) [(DC+/DC-) --> PE] (I_n)	10 kA	12.5 kA	12.5 kA	12.5 kA
Max. discharge current (8/20 μ s) [(DC+/DC-) --> PE] (I_{max})	20 kA	25 kA	25 kA	25 kA
Voltage protection level (U_p)	≤ 0.8 kV	≤ 2.5 kV	≤ 4 kV	≤ 4.5 kV
Approvals	KEMA, UL, CSA	KEMA, UL, CSA	KEMA, UL, CSA	KEMA, CSA

DEHNgard M YPV SCI ... FM

Modular multipole surge arrester with three-step d.c. switching device for use in PV systems; with remote signalling contact for monitoring device (floating changeover contact).



Type DG ...	M YPV SCI 150 FM	M YPV SCI 600 FM	M YPV SCI 1000 FM	M YPV SCI 1200 FM
Part No.	952 518	952 516	952 515	952 517
SPD according to EN 50539-11	type 2	type 2	type 2	type 2
Max. PV voltage (U_{CPV})	150 V	600 V	1000 V	1200 V
Short-circuit current rating (I_{SCPV})	10 kA	10 kA	10 kA	10 kA
Nominal discharge current (8/20 μ s) [(DC+/DC-) --> PE] (I_n)	10 kA	12.5 kA	12.5 kA	12.5 kA
Max. discharge current (8/20 μ s) [(DC+/DC-) --> PE] (I_{max})	20 kA	25 kA	25 kA	25 kA
Voltage protection level (U_p)	≤ 0.8 kV	≤ 2.5 kV	≤ 4 kV	≤ 4.5 kV
Approvals	KEMA, UL, CSA	KEMA, UL, CSA	KEMA, UL, CSA	KEMA, CSA
Type of remote signalling contact	changeover contact	changeover contact	changeover contact	changeover contact

DEHNgard S PV SCI ...

Modular single-pole surge arrester with three-step d.c. switching device for PV systems earthed on the d.c. side.



Type DG ...	S PV SCI 150	S PV SCI 600
Part No.	952 551	952 550
SPD according to EN 50539-11	type 2	type 2
Max. PV voltage (U_{CPV})	150 V	600 V
Short-circuit current rating (I_{SCPV})	10 kA	10 kA
Nominal discharge current (8/20 μ s) [(DC+/DC-) --> PE] (I_n)	10 kA	12.5 kA
Max. discharge current (8/20 μ s) [(DC+/DC-) --> PE] (I_{max})	20 kA	25 kA
Voltage protection level (U_p)	≤ 0.8 kV	≤ 2.5 kV
Approvals	KEMA, UL, CSA	KEMA, UL, CSA

DEHNgard S PV SCI ... FM

Modular single-pole surge arrester with three-step d.c. switching device for PV systems earthed on the d.c. side; with remote signalling contact for monitoring device (floating changeover contact).



Type DG ...	S PV SCI 150 FM	S PV SCI 600 FM
Part No.	952 556	952 555
SPD according to EN 50539-11	type 2	type 2
Max. PV voltage (U_{CPV})	150 V	600 V
Short-circuit current rating (I_{SCPV})	10 kA	10 kA
Nominal discharge current (8/20 μ s) [(DC+/DC-) --> PE] (I_n)	10 kA	12.5 kA
Max. discharge current (8/20 μ s) [(DC+/DC-) --> PE] (I_{max})	20 kA	25 kA
Voltage protection level (U_p)	≤ 0.8 kV	≤ 2.5 kV
Approvals	KEMA, UL, CSA	KEMA, UL, CSA
Type of remote signalling contact	changeover contact	changeover contact

Surge Arresters – Type 2 for PV Systems

DEHNgard M PV2 SCI ... (FM)

Modular multipole surge arrester with three-step d.c. switching device for protecting two MPP inputs; for use in PV systems up to 1000 V; FM version with floating remote signalling contact.

Type DG ...	M PV2 SCI 1000	M PV2 SCI 1000 FM
Part No.	952 514	952 519
SPD according to EN 50539-11	type 2	type 2
Max. PV voltage (U_{CPV})	1000 V	1000 V
Short-circuit current rating (I_{SCPV})	10 kA	10 kA
Nominal discharge current (8/20 μ s) [(DC+/DC-) --> PE] (I_n)	12.5 kA	12.5 kA
Max. discharge current (8/20 μ s) [(DC+/DC-) --> PE] (I_{max})	25 kA	25 kA
Voltage protection level (U_p)	≤ 4 kV	≤ 4 kV
Approvals	UL, KEMA	UL, KEMA
Type of remote signalling contact	—	changeover contact



DEHNgard M SN1868

Modular multipole surge arrester with three-step d.c. switching device for protecting 3 MPP inputs; for PV systems with remote signalling contact for monitoring device (floating changeover contact).

Type DG ...	M PV2 SCI SN1868 FM
Part No.	999 799
SPD according to EN 50539-11	type 2
Max. PV voltage (U_{CPV})	1000 V
Short-circuit current rating (I_{SCPV})	10 kA
Nominal discharge current (8/20 μ s) [(DC+/DC-) --> PE] (I_n)	12.5 kA
Max. discharge current (8/20 μ s) [(DC+/DC-) --> PE] (I_{max})	25 kA
Voltage protection level (U_p)	≤ 4 kV
Approvals	UL, KEMA
Type of remote signalling contact	changeover contact



Accessories for DEHNgard modular (Y)PV SCI ...

Varistor-Based Protection Module for DEHNgard M (S) (Y)PV SCI

Protection module with integrated back-up fuse for DEHNgard M (Y)PV SCI ... arresters comprising a varistor connected in parallel with a short-circuiting device.

Type DG MOD ...	PV SCI 75	PV SCI 300	PV SCI 500	PV SCI 600
Part No.	952 055	952 053	952 051	952 054
Max. continuous operating voltage (d.c.) (U_c)	75 V	300 V	500 V	600 V



Varistor-Based Protection Module for DEHNgard M (S) (Y)PV SCI

Varistor-based protection module for DEHNgard M YPV SCI ... and DEHNgard S PV SCI ... arresters.

Type DG MOD ...	PV 75	PV 300	PV 500	PV 600
Part No.	952 045	952 043	952 041	952 044
Max. continuous operating voltage (d.c.) (U_c)	75 V	300 V	500 V	600 V



DEHNgard modular E (Y)PV SCI 1500



For protecting low-voltage consumer installations against surges. For use in accordance with IEC 60364-7-712 (photovoltaic (PV) power systems).

Multipole/single-pole PV arresters with three-step d.c. switching device

- Prewired modular complete unit for use in photovoltaic systems up to 1500 V consisting of a base part and plug-in protection modules
- Combined disconnection and short-circuiting device with safe electrical isolation in the protection module (patented SCI principle)
- New design for safe use in PV systems up to 1500 V
- Tested to EN 50539-11
- Suitable for use in all PV systems in accordance with IEC 60364-7-712

DEHNgard ME YPV SCI 1500:

Modular multipole surge arrester with three-step d.c. switching device for PV systems up to 1500 V

DEHNgard SE PV SCI 1500:

For PV systems up to 1500 V solidly earthed on the d.c. side

DEHNgard ME/SE (Y)PV SCI 1500 FM: With remote signalling contact for monitoring device (floating changeover contact)

The modular DEHNgard ME YPV SCI 1500 (FM) and DEHNgard SE PV SCI 1500 (FM) surge arresters are specifically designed for protecting equipment in photovoltaic systems up to 1500 V. The new design of these arresters of the DEHNgard ... SCI family meets the increased requirements regarding such a high voltage range; this is reflected in the increased width (1.5 modules), additional terminal covers and a special terminal slot. The patented three-step d.c. switching device (SCI principle) makes these arresters particularly safe so that they fulfil all requirements in modern photovoltaic systems. The devices are specifically designed for PV systems with high system voltages (up to 1500 V). As with DEHNgard modular (Y)PV SCI ... (FM) arresters, which are available as 150 V, 600 V, 1000 V and 1200 V versions, they cover the most common voltage levels.

The application features of the modular Red/Line family design are as unique as the three-step d.c. switching device. The module locking system firmly fixes the protection modules to the base part. Neither shock nor vibration nor the enormous forces of discharge affect the safe connection to the protection module. Nevertheless, the protection modules can be easily replaced without tools by simply pressing the easy-to-use module release button of the protection modules. Every protective path of DEHNgard modular E (Y)PV SCI 1500 (FM) and every protection module is mechanically coded to guard against installing the incorrect module.

To fulfil the special requirements in photovoltaic systems, a fault-resistant Y circuit consisting of three protective paths of the varistor and a combined disconnection and short-circuiting device are integrated in a single device.

This synergy further reduces the probability of an arrester failure in case of the operating and fault states which have to be considered in photovoltaic systems. This ensures that the arrester is protected in case of overload. Even in case of operating voltages up to 1500 V d.c., a switching arc, which is likely to occur when a conventional disconnector (for a.c. applications) of a surge protective device is triggered, is extinguished immediately without risk.

DEHNgard SE PV SCI 1500 (FM) arresters are specifically designed for PV systems solidly earthed on the d.c. side; this type of earthing is meanwhile required, e.g. by manufacturers of special thin-film modules or for legal or normative reasons in some regions.

Since either the positive or the negative pole of the PV generator is solidly earthed, the optimised DEHNgard SE PV SCI 1500 (FM) arresters (one protection module is removed from the Y circuit) may be used if the distance from the earthing point does not exceed 5 m.

The green and red indicator flags show the availability of every protective circuit. Apart from this visual indication, DEHNgard ME YPV SCI 1500 FM und DEHNgard SE PV SCI 1500 FM arresters also feature a three-pole remote signalling terminal. As the remote signalling contact is designed as a floating changeover contact, the remote signal can, depending on the circuit concept, be used as a make or break contact.

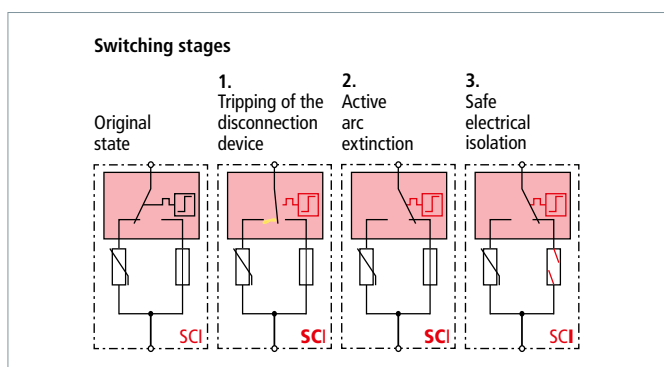

Three-step d.c. switching device (patented SCI principle)

Surge Arresters – Type 2 for PV Systems

DEHNgard ME YPV SCI 1500 (FM)

Modular multipole surge arrester with three-step d.c. switching device for PV systems.

Type DG ...	ME YPV SCI 1500	ME YPV SCI1500 FM
Part No.	952 520	952 525
SPD according to EN 50539-11	type 2	type 2
Max. PV voltage (U_{CPV})	1500 V	1500 V
Short-circuit current rating (I_{SCPV})	10 kA	10 kA
Total discharge current (8/20 μ s) (I_{total})	25 kA	25 kA
Nominal discharge current (8/20 μ s) [(DC+/DC-) --> PE] (I_n)	12.5 kA	12.5 kA
Voltage protection level (U_P)	≤ 6 kV	≤ 6 kV
Approvals	KEMA, UL	KEMA, UL
Type of remote signalling contact	—	changeover contact



DEHNgard SE PV SCI 1500 (FM)

Modular single-pole surge arrester with three-step d.c. switching device for PV systems earthed on the d.c. side; FM version with floating remote signalling contact.

Type DG ...	SE PV SCI 1500	SE PV SCI 1500 FM
Part No.	952 561	952 566
SPD according to EN 50539-11	type 2	type 2
Max. PV voltage (U_{CPV})	1500 V	1500 V
Short-circuit current rating (I_{SCPV})	10 kA	10 kA
Nominal discharge current (8/20 μ s) [(DC+/DC-) --> PE] (I_n)	12.5 kA	12.5 kA
Voltage protection level (U_P)	≤ 6 kV	≤ 6 kV
Approvals	KEMA, UL	KEMA, UL
Type of remote signalling contact	—	changeover contact



Accessories for DEHNgard modular E (Y)PV SCI 1500

Varistor-Based Protection Module for DEHNgard ME YPV SCI and DEHNgard SE PV SCI

Varistor-based protection module for DEHNgard ME YPV SCI 1500 (FM) and DEHNgard SE PV SCI 1500 (FM)

Type	DG MOD E PV SCI 750
Part No.	952 056
Max. continuous operating voltage (d.c.) (U_C)	750 V



DEHNguard YPV SCI ... – compact



For protecting low-voltage consumer installations against surges. For use in accordance with IEC 60364-7-712 (photovoltaic (PV) power systems).

Compact PV arrester with three-step d.c. switching device

- Prewired complete unit for use in photovoltaic systems
- Combined disconnection and short-circuiting device with safe electrical isolation (patented SCI principle)
- Tried and tested fault-resistant Y circuit of DEHNguard YPV SCI ... prevents damage to the surge protective device in case of insulation faults in the generator circuit
- Tested to EN 50539-11
- Suitable for use in all PV systems according to IEC 60364-7-712

DEHNguard YPV SCI 600/1000: Multipole surge arrester with three-step d.c. switching device; for photovoltaic systems up to 600/1000 V

DEHNguard YPV SCI ... FM: With remote signalling contact for monitoring device (floating changeover contact)

The DEHNguard YPV SCI ... surge arresters are specifically designed for protecting equipment in photovoltaic systems. The patented three-step d.c. switching device (SCI principle) makes these arresters particularly safe so that they fulfil all requirements in modern photovoltaic systems. The devices are available as 600 V and 1000 V versions and cover the most common voltage levels for string inverter systems.

To fulfil the special requirements in photovoltaic systems, a fault-resistant Y circuit consisting of three protective paths of the varistor and a combined disconnection and short-circuiting device are integrated in a single device.

This synergy further reduces the probability of an arrester failure in case of the operating and fault states which have to be considered in photovoltaic systems. This ensures that the arrester is protected in case of overload. Even in case of voltages up to 1000 V d.c., a switching arc, which is likely to occur when a conventional disconnector (for a.c. applications) of a surge protective device is triggered, is extinguished immediately without risk.

DEHNguard YPV SCI ... is a special cost-effective and application-optimised device which is particularly designed for string inverter systems with a limited system current up to 1000 A. The design includes the main device features without compromising safety.

The green and red indicator flags show the availability of every protective circuit. Apart from this visual indication, DEHNguard YPV SCI ... (FM) arresters also feature a three-pole remote signalling terminal. As the remote signalling contact is designed as a floating changeover contact, the remote signal can, depending on the circuit concept, be used as a make or break contact.

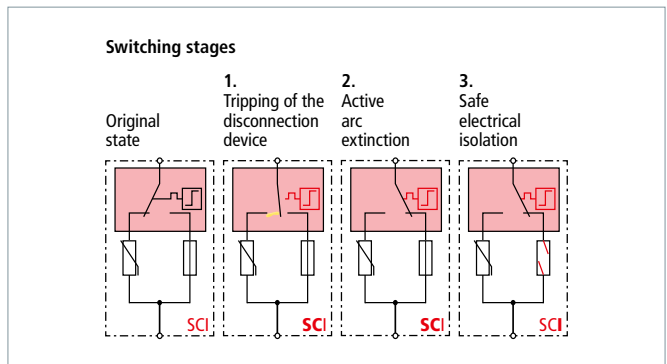

Three-step d.c. switching device (patented SCI principle)

DEHNguard compact YPV SCI ... FM

Multipole surge arrester with three-step d.c. switching device for use in PV systems, with remote signalling contact for monitoring device (floating changeover contact).



Type DG YPV SCI ...	600	600 FM	1000	1000 FM
Part No.	950 531	950 536	950 530	950 535
SPD according to EN 50539-11	type 2	type 2	type 2	type 2
Max. PV voltage (U _{CPV})	600 V	600 V	1000 V	1000 V
Short-circuit current rating (I _{SCPV})	1000 A	1000 A	1000 A	1000 A
Nominal discharge current (8/20 μs) [(DC+/DC-) --> PE] (I _n)	12.5 kA	12.5 kA	12.5 kA	12.5 kA
Max. discharge current (8/20 μs) [(DC+/DC-) --> PE] (I _{max})	25 kA	25 kA	25 kA	25 kA
Voltage protection level (U _p)	≤ 2.5 kV	≤ 2.5 kV	≤ 4 kV	≤ 4 kV
Approvals	KEMA, UL	KEMA, UL	KEMA, UL	KEMA, UL
Type of remote signalling contact	—	changeover contact	—	changeover contact

DEHNcube

- Prewired multipole surge arrester with IP 65 degree of protection for use in photovoltaic systems
- No space required in a distribution board enclosure
- Pre-assembled connecting cable available for simple connection of the surge arrester directly upstream of the inverter to be protected
- Combined disconnection and short-circuiting device with safe electrical isolation in every protective path (patented SCI principle)
- Spring-loaded terminals for easy and quick connection without tools
- Tested to EN 50539-11
- For use in all PV systems according to IEC 60364-7-712



For protecting low-voltage consumer installations against surges. For use in accordance with IEC 60364-7-712 (photovoltaic (PV) power systems).

DEHNcube YPV SCI 1000 1M: Two-pole surge arrester with IP 65 degree of protection and three-step d.c. switching device for protecting one MPP input; for PV systems up to 1000 V

DEHNcube YPV SCI 1000 2M: Four-pole surge arrester with IP 65 degree of protection and three-step d.c. switching device for protecting two MPP inputs; for PV systems up to 1000 V

The robust and flexible surge arresters of the DEHNcube YPV SCI 1000 ... family are specifically developed for protecting equipment in photovoltaic systems. The patented three-step d.c. switching device (SCI principle) makes these devices particularly safe so that they fulfil all requirements in modern photovoltaic systems.

DEHNcube YPV SCI 1000 ... is the first surge arrester with IP 65 degree of protection from DEHN that is tested to EN 50539-11. Thus, no space is required in a distribution board enclosure or a distribution board enclosure does not have to be installed just for the surge protective device as is the case with standard DIN rail mounted arresters. DEHNcube YPV SCI 1000 ... may be installed right next to the inverter to be protected, i.e. it is ideally suited for quickly and easily retrofitting a surge protective device in an existing PV system.

The optional pre-assembled Y connecting cable ensures easy connection of DEHNcube YPV SCI 1000 ... The connecting cable is designed in such a way that the cable length can be individually shortened to the optimal length, thus ensuring maximum protection due to lower transmission loss. To fulfil the special requirements in PV systems, the approved fault-resistant Y circuit consisting of three protective paths of the varistor and a combined disconnection and short-circuiting device are integrated in a single device.

This synergy further reduces the probability of an arrester failure in case of the operating and fault states which have to be considered in PV systems.

This ensures that the arrester is protected in case of overload. Even in case of voltages up to 1000 V d.c., a switching arc, which is likely to occur when a conventional disconnecter of a surge protective device is triggered, is extinguished immediately without risk. This is ensured by its approved fault-resistant Y circuit which prevents damage to the surge protection in case of insulation faults in the generator circuit.

To ensure safe electrical isolation in case of a faulty surge protective device, a fuse which was particularly developed for PV systems was integrated into the short-circuit path. This unique design combines surge and personal protection and allows DEHNcube YPV SCI 1000 ... to be used in all low, medium and high-performance photovoltaic systems without additional backup fuse.

DEHNcube YPV SCI 1000 ... is a special type 2 surge protective device, which may be quickly installed directly next to the equipment of the PV generator circuit it is supposed to protect without requiring an additional insulating enclosure. The IP 65 degree of protection ensures that it is dust-proof and jet-water-tight. A pressure compensating element with an air-permeable and water-tight special grommet which avoids condensation in the enclosure is imperative for safe outdoor use and is therefore already integrated as a standard.

The Y connecting cable, which is available as accessory, allows easy wiring of DEHNcube YPV SCI 1000 ... The next pages show sample applications of the connecting cable.

DEHNcube YPV SCI 1000 1M / 2M

Two-pole / four pole surge arrester with IP 65 degree of protection and three-step d.c. switching device for PV inverters for protecting one / two MPP inputs.

Type DCU YPV SCI 1000 ...	1M	2M
Part No.	900 910	900 920
SPD according to EN 50539-11	type 2	type 2
Max. PV voltage (U_{CPV})	1000 V	1000 V
Short-circuit current rating (I_{SCPV})	1000 A	1000 A
Nominal discharge current (8/20 μ s) [(DC+/DC-) --> PE] (I_n)	12.5 kA	12.5 kA
Max. discharge current (8/20 μ s) [(DC+/DC-) --> PE] (I_{max})	25 kA	25 kA
Voltage protection level (U_p)	≤ 4 kV	≤ 4 kV
Degree of protection	IP 65	IP 65



Connecting Cable for DEHNcube



Prewired connecting cables for easily connecting the incoming string lines to DEHNcube and the inverter.

NEW

- PV connecting cables for easily connecting DEHNcube YPV SCI 1000 ... to the inverter
- Suitable for outdoor use
- 6 mm² for minimum voltage drop
- Cable can be shortened individually to the optimum length
- Unnecessary cable lengths are avoided, thus better protective effect due to lower transmission loss

AL DCU Y PV L3X1000: For connecting strings to DEHNcube and the inverter

To ensure easy and quick connection of the DEHNcube YPV SCI 1000 1M and DEHNcube YPV SCI 1000 2M surge arresters, DEHN offers the pre-assembled connecting cables AL DCU Y PV L3X1000 which can be used to conveniently connect the string lines to DEHNcube and the inverter.

The AL DCU Y PV connecting cable allows you to connect a string to the input of an inverter to protect it from surges. This cable features three ends for connection to the inverter, DEHNcube and the string line. The designation Y symbolises the three cable ends.

The cables can be individually shortened to the required length. This ensures optimum cable routing, avoiding unnecessary cable lengths to achieve a better protective effect and keep transmission losses as low as possible. The connecting cables have a cross-section of 6 mm² which means that transmission loss is reduced to a minimum. Due to their design, they are suitable for outdoor use in PV systems.

The figure shows an example of how to connect an inverter with DEHNcube and two string lines (DC+/DC-). In this case, two AL DCU Y PV L3X1000 connecting cables are required.

The applications shown here can also be used for inverters with two MPP inputs which are protected by DCU YPV SCI 1000 2M.

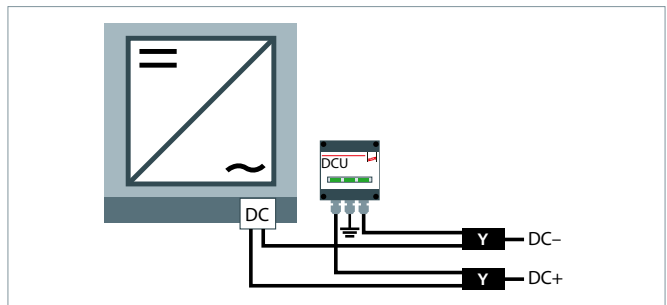

Application: One string per d.c. input (MPP tracker) of the inverter.

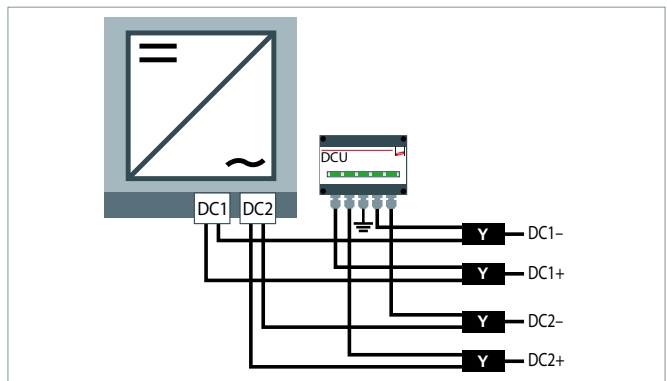

Example: DCU YPV SCI 1000 2M.

Surge Arresters – Type 2

Y Connecting Cable for DEHNcube

Allows to collect one PV string and connect it to DEHNcube and the inverter.

Type	AL DCU Y PV L3X1000
Part No.	900 945 <small>NEW</small>
For connecting	1 string
Cable cross-section	6 mm ²
Cable material	Cu
Degree of protection	IP 65
Length	3x 1000 mm



NEW



DEHNguard PCB

- Base for DEHNguard protection modules to be mounted on and integrated in PCBs
- Optimal integration of a type 2 arrester in devices
- Easy and flexible use for all circuit configurations
- Proven DEHNguard modules ensure high performance
- Coded base and protection module guard against installing an incorrect module
- Version with and without remote signalling contact for the monitoring device
- Versions for maximum requirements on clearances and creepage distances
- Versions for other DEHNguard protection modules available on request



For integrating a type 2 arrester on the printed circuit board of a device to provide surge protection. For installation in conformity with the lightning protection zone concept at the boundaries from 0_B-1 and higher.

DEHNguard PCB ...: Base for mounting arresters on printed circuit boards

DEHNguard PCB ... FM: With remote signalling contact for monitoring device (floating changeover contact)

DEHNguard PCB ... I ... FM: With increased clearances and creepage distances between the power and remote signalling contact

The single-pole DEHNguard PCB ... (FM) base is specially designed for use on printed circuit boards (PCBs). Thus, surge protection can be taken into account at an early stage of development of the PCB and can be optimally integrated in the overall product. This single-pole version can be used for all system configurations. Fault-resistant Y circuits for PV systems or 3+1 configurations for a.c. systems can be easily implemented.

Thanks to the ideal positioning of the SPD on the device, an optimal voltage protection level is achieved for the electronics of the PCB since there is no cable length between the SPD and the device to be protected through which additional surges may be injected (in typical applications). The design of the PCB also allows series connection according to IEC 60364-5-53.

Various device features show that reliable surge protection and equipment reliability are a top priority of the modular DEHNguard. The application-oriented product designation, which makes it considerably easier to assign the protection modules to the relevant DG PCB base part, and the unique module locking system reflect the high safety requirements. The module locking system firmly fixes the protection modules to DEHNguard

PCB (FM). Neither vibration in the application environment nor the dynamic forces of discharge can loosen the protection modules. Nevertheless, they can be easily replaced without tools by simply pressing the easy-to-use module release button of the protection modules.

Each DEHNguard PCB (FM) base and each protection module is mechanically coded to guard against installing an incorrect module.

The DG PCB ... I ... FM versions ensure increased distances between the power and remote signalling contact since special applications place increased requirements on clearances and creepage distances between these circuits. Details can be found in the drilling scheme of the installation instructions which can be downloaded free of charge at www.dehn-international.com.

The ...FM version of DG PCB... features a three-pole remote signalling contact. As the remote signalling contact is designed as a floating changeover contact, the remote signal can, depending on the circuit concept, be used as a make or break contact.

DEHNguard PCB PV SCI ...

Single-pole base for DEHNguard modules to be mounted on the PCBs of devices.

Type DG PCB ...	PV SCI 300	PV SCI 500	PV SCI 600
Part No.	952 653	952 651	952 654
Associated protection module	DG MOD PV SCI 300 (Part No. 952 053)	DG MOD PV SCI 500 (Part No. 952 051)	DG MOD PV SCI 600 (Part No. 952 054)
Max. continuous operating voltage (d.c.) (module)	300 V	500 V	600 V
For mounting on	directly soldered into PCB	directly soldered into PCB	directly soldered into PCB
Degree of protection	IP 20 (protection module plugged in)	IP 20 (protection module plugged in)	IP 20 (protection module plugged in)



DEHNGuard PCB PV SCI ... FM

Single-pole base for DEHNGuard modules to be mounted on the PCBs of devices, with remote signalling contact for the monitoring system (floating changeover contact).



Type DG PCB ...	PV SCI 300 FM	PV SCI 500 FM	PV SCI 600 FM
Part No.	952 753	952 751	952 754
Associated protection module	DG MOD PV SCI 300 (Part No. 952 053)	DG MOD PV SCI 500 (Part No. 952 051)	DG MOD PV SCI 600 (Part No. 952 054)
Max. continuous operating voltage (d.c.) (module)	300 V	500 V	600 V
For mounting on	directly soldered into PCB	directly soldered into PCB	directly soldered into PCB
Degree of protection	IP 20 (protection module plugged in)	IP 20 (protection module plugged in)	IP 20 (protection module plugged in)
Type of remote signalling contact	changeover contact	changeover contact	changeover contact

DEHNGuard PCB PV ...

Single-pole base for DEHNGuard modules to be mounted on the PCBs of devices.



Type DG PCB ...	PV 300	PV 500	PV 600
Part No.	952 643	952 641	952 644
Associated protection module	DG MOD PV 300 (Part No. 952 043)	DG MOD PV 500 (Part No. 952 041)	DG MOD PV 600 (Part No. 952 044)
Max. continuous operating voltage (d.c.) (module)	300 V	500 V	600 V
For mounting on	directly soldered into PCB	directly soldered into PCB	directly soldered into PCB
Degree of protection	IP 20 (protection module plugged in)	IP 20 (protection module plugged in)	IP 20 (protection module plugged in)

DEHNGuard PCB PV ... FM

Single-pole base for DEHNGuard modules to be mounted on the PCBs of devices, with remote signalling contact for the monitoring system (floating changeover contact).



Type DG PCB ...	PV 300 FM	PV 500 FM	PV 600 FM
Part No.	952 743	952 741	952 744
Associated protection module	DG MOD PV 300 (Part No. 952 043)	DG MOD PV 500 (Part No. 952 041)	DG MOD PV 600 (Part No. 952 044)
Max. continuous operating voltage (d.c.) (module)	300 V	500 V	600 V
For mounting on	directly soldered into PCB	directly soldered into PCB	directly soldered into PCB
Degree of protection	IP 20 (protection module plugged in)	IP 20 (protection module plugged in)	IP 20 (protection module plugged in)
Type of remote signalling contact	changeover contact	changeover contact	changeover contact

DEHNGuard PCB ...

Single-pole base for DEHNGuard modules to be mounted on the PCBs of devices.



Type DG PCB ...	275	385
Part No.	952 610	952 614
Associated protection module	DG MOD 275 (Part No. 952 010)	DG MOD 385 (Part No. 952 014)
Max. continuous operating voltage (a.c.) (module)	275 V	385 V
For mounting on	directly soldered into PCB	directly soldered into PCB
Degree of protection	IP 20 (protection module plugged in)	IP 20 (protection module plugged in)

DEHNGuard PCB ... FM

Single-pole base for DEHNGuard modules to be mounted on the PCBs of devices, with remote signalling contact for the monitoring system (floating changeover contact).



Type DG PCB ...	275 FM	385 FM
Part No.	952 710	952 714
Associated protection module	DG MOD 275 (Part No. 952 010)	DG MOD 385 (Part No. 952 014)
Max. continuous operating voltage (a.c.) (module)	275 V	385 V
For mounting on	directly soldered into PCB	directly soldered into PCB
Degree of protection	IP 20 (protection module plugged in)	IP 20 (protection module plugged in)
Type of remote signalling contact	changeover contact	changeover contact

DEHNgard PCB NPE (FM)

Single-pole base for DEHNgard modules to be mounted on the PCBs of devices, with remote signalling contact for the monitoring system (floating changeover contact).

Type DG PCB ...	NPE	NPE FM
Part No.	952 650	952 750
Associated protection module	DG MOD NPE (Part No. 952 050)	DG MOD NPE (Part No. 952 050)
Max. continuous operating voltage (a.c.) (module)	255 V	255 V
For mounting on	directly soldered into PCB	directly soldered into PCB
Degree of protection	IP 20 (protection module plugged in)	IP 20 (protection module plugged in)
Type of remote signalling contact	—	changeover contact



DEHNgard PCB PV I ... FM

Single-pole base with increased clearance and creepage distance between the power contacts and the remote signalling contact. For installation on the PCBs of devices to accommodate DEHNgard modules, with remote signalling contact for the monitoring system (floating changeover contact).

Type DG PCB ...	PV I 500 FM	PV I 600 FM	PV I 750 FM
Part No.	952 941	952 948	952 949
Associated protection module	DG MOD PV 500 (Part No. 952 041)	DG MOD H PV 600 (Part No. 952 048)	DG MOD H PV 750 (Part No. 952 049)
Max. continuous operating voltage (d.c.) (module)	500 V	600 V	750 V
For mounting on	directly soldered into PCB	directly soldered into PCB	directly soldered into PCB
Degree of protection	IP 20 (protection module plugged in)	IP 20 (protection module plugged in)	IP 20 (protection module plugged in)
Type of remote signalling contact	changeover contact	changeover contact	changeover contact



DEHNgard PCB PVSCI I ...FM

Single-pole base with increased clearance and creepage distance between the power contacts and the remote signalling contact. For installation on the PCBs of devices to accommodate DEHNgard modules, with remote signalling contact for the monitoring system (floating changeover contact).

Type DG PCB ...	PVSCI I 500FM
Part No.	952 951
Associated protection module	DG MOD PV SCI 500 (Part No. 952 051)
Max. continuous operating voltage (d.c.) (module)	500 V
For mounting on	directly soldered into PCB
Degree of protection	IP 20 (protection module plugged in)
Type of remote signalling contact	changeover contact



DEHNgard PCB I ... FM

Single-pole base with increased clearance and creepage distance between the power contacts and the remote signalling contact. For installation on the PCB's of devices to accommodate DEHNgard modules, with remote signalling contact for the monitoring system (floating changeover contact).

Type DG PCB ...	I 275 FM
Part No.	952 910
Associated protection module	DG MOD 275 (Part No. 952 010)
Max. continuous operating voltage (a.c.) (module)	275 V
For mounting on	directly soldered into PCB
Degree of protection	IP 20 (protection module plugged in)
Type of remote signalling contact	changeover contact





Protection Module for DEHNguard M, ... S and DEHNgap C S

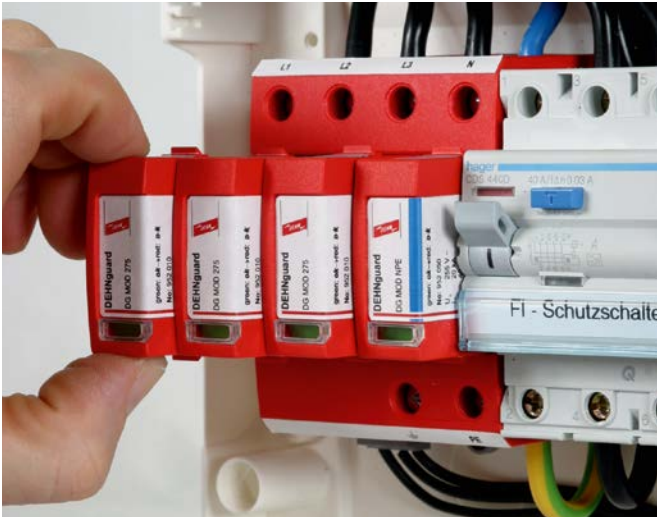

For protecting low-voltage consumer installations against surges. For installation in conformity with the lightning protection zone concept at the boundaries from $O_B - 1$ and higher.

- High discharge capacity due to heavy-duty zinc oxide varistors / spark gaps
- High reliability due to "Thermo Dynamic Control" SPD monitoring device
- Energy coordination with other arresters of the Red/Line product family
- Operating state / fault indication by green / red indicator flag in the inspection window
- Easy replacement of protection modules without tools due to module locking system with module release button
- The plug-in protection module can be replaced without disconnecting the supply voltage and without removing the distribution board cover
- Vibration and shock-tested according to EN 60068-2

DEHNguard MOD ACI ...:	Switch / spark gap protection module for DEHNguard M ACI and DEHNguard S ACI
DEHNguard MOD A 275:	Varistor-based protection module for DEHNguard M ACI
DEHNguard MOD CI 275:	Varistor-based protection module for DEHNguard M CI ...
DEHNguard MOD E CI...:	Varistor-based protection module for DEHNguard M ... and DEHNguard SE CI ...
DEHNguard MOD ...:	Varistor-based protection module for DEHNguard M ... and DEHNguard S ...
DEHNguard MOD 750:	Varistor-based protection module for DEHNguard M WE 600 and DEHNguard S WE 600
DEHNguard MOD A H NPE:	N-PE spark-gap-based protection module for DEHNguard M ACI
DEHNguard MOD H NPE:	N-PE spark-gap-based protection module for two-pole and four-pole DEHNguard M H TT ...
DEHNguard MOD NPE:	N-PE spark-gap-based protection module for two-pole and four-pole DEHNguard M TT ...
DEHNgap C MOD:	N-PE spark-gap-based protection module for single-pole N-PE surge arresters of type DEHNgap C S ...
DEHNguard MOD ... VA:	Varistor-based and spark-gap-based protection module for DEHNguard S ... VA
DEHNguard MOD H PV ...:	Varistor-based protection module for DEHNguard M YPV ...
DEHNguard MOD PV SCI ...:	Varistor-based protection module for DEHNguard M YPV SCI and DEHNguard S PV SCI ...
DEHNguard MOD PV ...:	Varistor-based protection module for DEHNguard M YPV SCI and DEHNguard S PV SCI ...
DEHNguard MOD E PV SCI 750:	Varistor-based protection module for DEHNguard ME YPV SCI and DEHNguard SE PV SCI ...
DEHNguard MOD E H 1000:	Varistor-based protection module for DEHNguard SE H 1000 FM
DEHNguard MOD E H 1000 VA:	Varistor-based protection module for DEHNguard SE H 1000 VA FM
DEHNguard MOD E DC ...:	Varistor-based protection module for DEHNguard SE DC ...

The varistor and spark-gap-based protection modules of the DEHNguard M, DEHNguard S, DEHNguard ME, DEHNguard SE and DEHNgap C S devices distinguish themselves through their outstanding performance and appearance.

The compact protection modules incorporate the complete protective circuit as well as the monitoring and disconnection device.

The green indicator flag in the inspection window shows the operating state of the protection modules.

All protection modules are mechanically coded to guard against installing an incorrect module.

The protection modules can be easily replaced without tools by simply pressing the easy-to-use module release button.

Avoid additional, short-notice and unplanned maintenance jobs.
In multipole protective circuits, we recommend replacing the complete set of protection modules when one module fails.

NEW



Switch-Spark Gap Protection Module for DEHNguard M ACI

Type	DG MOD ACI 275	DG MOD ACI 385
Part No.	952 024 ^{NEW}	952 028 ^{NEW}
Nominal discharge current (8/20 μ s) (I_n)	20 kA	20 kA
Max. continuous operating voltage (a.c.) (U_C)	275 V	385 V

NEW



Spark-Gap-Based Protection Module for DEHNguard M ACI

Type	DG MOD A NPE
Part No.	952 022 ^{NEW}
Nominal discharge current (8/20 μ s) (I_n)	20 kA
Max. continuous operating voltage (a.c.) (U_C)	255 V

Varistor-Based Protection Module for DEHNgard M CI

Type	DG MOD CI 275
Part No.	952 020 
Nominal discharge current (8/20 μs) (I _n)	12.5 kA
Max. discharge current (8/20 μs) (I _{max})	25 kA
Max. continuous operating voltage (a.c.) (U _c)	275 V



Varistor-based Protection Module for DEHNgard SE CI ...

Type	DG MOD E CI 440	DG MOD E CI WE 440
Part No.	952 926	952 927
Nominal discharge current (8/20 μs) (I _n)	12.5 kA	12.5 kA
Max. continuous operating voltage (a.c.) (U _c)	440 V	440 V
Rated varistor voltage (U _{mov})	440 V	750 V



Varistor-based Protection Module for DEHNgard M and DEHNgard S

Type	DG MOD 48	DG MOD 75	DG MOD 150	DG MOD 275
Part No.	952 018	952 011	952 012	952 010
Nominal discharge current (8/20 μs) (I _n)	7.5 kA	10 kA	15 kA	20 kA
Max. discharge current (8/20 μs) (I _{max})	25 kA	40 kA	40 kA	40 kA
Max. continuous operating voltage (a.c.) (U _c)	48 V	75 V	150 V	275 V

Type	DG MOD 320	DG MOD 385	DG MOD 440	DG MOD 600
Part No.	952 013	952 014	952 015	952 016
Nominal discharge current (8/20 μs) (I _n)	20 kA	20 kA	20 kA	15 kA
Max. discharge current (8/20 μs) (I _{max})	40 kA	40 kA	40 kA	30 kA
Max. continuous operating voltage (a.c.) (U _c)	320 V	385 V	440 V	600 V



Varistor-Based Protection Module for DEHNgard M (S) WE

Type	DG MOD 750
Part No.	952 017
Nominal discharge current (8/20 μs) (I _n)	15 kA
Max. discharge current (8/20 μs) (I _{max})	25 kA
Max. continuous operating voltage (a.c.) (U _c)	600 V
Rated varistor voltage (U _{mov})	750 V



N-PE Spark-Gap-Based Protection Module for DEHNgard M ACI

N-PE spark-gap-based protection module for two-pole and four-pole DEHNgard DG M TT (2P) ACI ...

Type	DG MOD H A NPE
Part No.	952 083 
Nominal discharge current (8/20 μs) (I _n)	80 kA
Max. continuous operating voltage (a.c.) (U _c)	275 V

NEW



N-PE Spark-Gap-Based Protection Module for DEHNgard M H TT ...

Type	DG MOD H NPE
Part No.	952 081
Nominal discharge current (8/20 μs) (I _n)	80 kA
Max. discharge current (8/20 μs) (I _{max})	120 kA
Max. continuous operating voltage (a.c.) (U _c)	255 V



N-PE Spark-Gap-Based Protection Module for DEHNgard M TT ...

Type	DG MOD NPE
Part No.	952 050
Nominal discharge current (8/20 μs) (I _n)	20 kA
Max. discharge current (8/20 μs) (I _{max})	40 kA
Max. continuous operating voltage (a.c.) (U _c)	255 V



N-PE Spark-Gap-Based Protection Module for DEHNgap C S

Type	DGP C MOD
Part No.	952 060
Nominal discharge current (8/20 μs) (I _n)	20 kA
Max. discharge current (8/20 μs) (I _{max})	40 kA
Max. continuous operating voltage (a.c.) (U _c)	255 V



Varistor and Spark-Gap-Based Protection Module for DEHNgard S ... VA



Type	DG MOD 75 VA	DG MOD 275 VA	DG MOD 385 VA
Part No.	952 025	952 027	952 029
Nominal discharge current (8/20 μs) (I _n)	10 kA	10 kA	10 kA
Max. discharge current (8/20 μs) (I _{max})	20 kA	20 kA	20 kA
Max. continuous operating voltage (a.c.) (U _c)	75 V	275 V	385 V
Max. continuous operating voltage (d.c.) (U _c)	100 V	350 V	500 V

Varistor-based Protection Module for DEHNgard M YPV



Type	DG MOD H PV 600	DG MOD H PV 750
Part No.	952 048	952 049
Nominal discharge current (8/20 μs) (I _n)	20 kA	15 kA
Max. discharge current (8/20 μs) (I _{max})	40 kA	40 kA
Max. continuous operating voltage (d.c.) (U _c)	600 V	750 V

Varistor-Based Protection Module for DEHNgard M YPV SCI and DEHNgard S PV SCI



Type DG MOD ...	PV SCI 75	PV SCI 300	PV SCI 500	PV SCI 600
Part No.	952 055	952 053	952 051	952 054
Nominal discharge current (8/20 μs) (I _n)	10 kA	12.5 kA	12.5 kA	12.5 kA
Max. discharge current (8/20 μs) (I _{max})	20 kA	25 kA	25 kA	25 kA
Max. continuous operating voltage (d.c.) (U _c)	75 V	300 V	500 V	600 V

Varistor-Based Protection Module for DEHNgard M YPV SCI and DEHNgard S PV SCI



Type	DG MOD PV 75	DG MOD PV 300	DG MOD PV 500	DG MOD PV 600
Part No.	952 045	952 043	952 041	952 044
Nominal discharge current (8/20 μs) (I _n)	10 kA	20 kA	20 kA	15 kA
Max. discharge current (8/20 μs) (I _{max})	40 kA	40 kA	40 kA	30 kA
Max. continuous operating voltage (d.c.) (U _c)	75 V	300 V	500 V	600 V

Varistor-Based Protection Module for DEHNgard ME YPV SCI and DEHNgard SE PV SCI



Type	DG MOD E PV SCI 750
Part No.	952 056
Nominal discharge current (8/20 μs) (I _n)	12.5 kA
Max. discharge current (8/20 μs) (I _{max})	25 kA
Max. continuous operating voltage (d.c.) (U _c)	750 V

Varistor-Based Protection Module for DEHNgard SE H ...



Type	DG MOD E H 1000	DG MOD E H 1000 VA
Part No.	952 908	952 918
Nominal discharge current (8/20 μs) (I _n)	20 kA	15 kA
Max. discharge current (8/20 μs) (I _{max})	40 kA	40 kA
Max. continuous operating voltage (a.c.) (U _c)	1000 V	1000 V

Varistor-based Protection Module for DEHNgard SE DC



Type DG MOD ...	E DC 60	E DC 242	E DC 550	E DC 900
Part No.	972 010	972 020	972 030	972 040
Nominal discharge current (8/20 μs) (I _n)	12.5 kA	12.5 kA	12.5 kA	12.5 kA
Max. continuous operating voltage (d.c.) (U _c)	60 V	242 V	550 V	900 V



DEHNguard 1000

- High discharge capacity due to heavy-duty zinc oxide varistor
- Quick response
- High reliability due to "Thermo Dynamic Control" disconnecter
- Fault indication by green / red indicator flag in the inspection window
- Specifically designed for high system voltages



For protecting low voltage consumer installations against surges. For installation in conformity with the lightning protection zone concept at the boundaries from $O_B - 1$ and higher.

DEHNguard 1000: Compact single-pole surge arrester with a rated voltage $U_c = 1000$ V a.c. or 1000 V d.c.

DEHNguard 1000 FM: With remote signalling contact for monitoring device (floating changeover contact)

With a rated voltage of 1000 V, the compact and powerful single-pole DEHNguard 1000 (FM) surge arresters can be used for a wide range of applications.

The DEHNguard family is not only characterised by its high degree of flexibility, but also by its distinctive performance parameters which set standards worldwide: The high discharge capacity, low voltage protection level and dual "Thermo Dynamic Control" monitoring and disconnection device ensure maximum reliability.

The DEHN-specific "Thermo Dynamic Control" disconnecter ensures that the arresters change into a safe, isolated state even in case of extreme overload. For this purpose, the surface temperature of the heavy-duty varistor and the intensity of the discharge current are used for evaluation.

The external design of the device reflects its field of application. DEHNguard 1000 (FM), with a width of two modules, entirely fulfils all mechanical requirements resulting from the high system voltages.

Apart from the standard visual indication with green and red indicator flags, DEHNguard ... FM arresters feature a three-pole remote signalling terminal. As the remote signalling contact is designed as a floating changeover contact, the remote signal can, depending on the circuit concept, be used as a make or break contact.



DEHNguard 1000 (FM)

Compact single-pole surge arrester; FM version with floating remote signalling contact.

Type DG ...	1000	1000 FM
Part No.	950 102	950 112
SPD according to EN 61643-11 / IEC 61643-11	type 2 / class II	type 2 / class II
Max. continuous operating voltage (a.c.) (U_c)	1000 V (50 / 60 Hz)	1000 V (50 / 60 Hz)
Max. discharge current (8/20 μ s) (I_{max})	30 kA	30 kA
Voltage protection level (U_p)	≤ 4.2 kV	≤ 4.2 kV
Max. overcurrent protection	100 A aM	100 A aM
Max. overcurrent protection at $U \leq 690$ V a.c.	125 A gG	125 A gG
Approvals	UL	UL
Type of remote signalling contact	—	changeover contact



Accessories for DEHNguard 1000

Earthing Clip for two-module Enclosures, single-phase, two-pole / three-pole / four-pole

Earthing clip for connecting the earth terminal of e.g. two / three / four SPDs with two-module enclosure to earth, with terminal.

Type	EB 1 2 5	EB DG 1000 1 3	EB 1 4 9
Part No.	900 419	900 411	900 417
Dimensions	34 x 77 x 28 mm	34 x 112 x 28 mm	34 x 148 x 28 mm
Terminal	up to 25 mm ²	up to 25 mm ²	up to 25 mm ²



V NH / VA NH

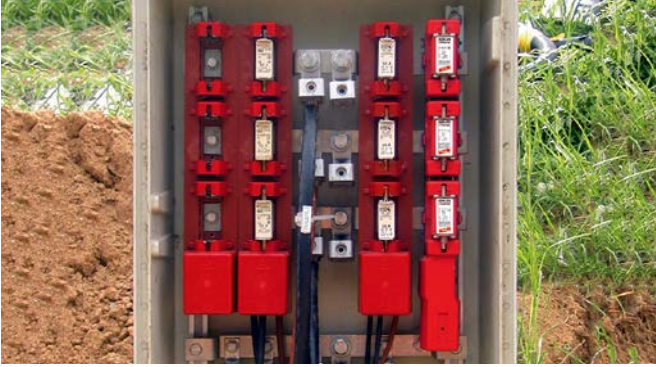

For protecting low voltage consumer installations against surges. For installation in conformity with the lightning protection zone concept at the boundaries from $O_B - 1$ and higher. German patented design.

V(A) NH00 2a80: Surge arrester for use in NH00 fuse holders

V(A) NH1 280: Surge arrester for use in NH1 fuse holders

V(A) NH00 280 FM: With fault indicator for remote signalling; allows for use of NH fuse holders with microswitch (max. tripping distance of indicator of 7 mm)

The single-pole V NH and VA NH surge arresters show that surge protective devices do not necessarily have to be designed for DIN rails or socket outlets. Adapted to the requirements in industrial sub-circuit distribution boards, V NH and VA NH surge arresters are designed in the form of an NH fuse holder. This makes integration into busbar systems, as they are frequently used in the environment of utility and in industrial plants, easy. Thus, these surge protective devices offer all the advantages of busbar systems such as easy installation, low installation time and reduced wiring. The idea of such a busbar system is consistently followed up with arresters in NH design. V NH and VA NH surge arresters can be installed and removed by means of a fuse switch-disconnector and a fuse handle. This considerably facilitates insulation measurements in the installation as the arrester does not have to be disconnected any more.

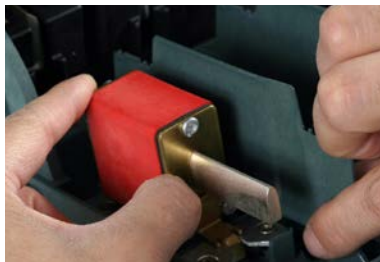

Another considerable advantage of the V NH / VA NH family is that a backup fuse is already integrated in the arrester. In case of earth-fault and short-circuit-proof wiring, this saves significant costs and reduces space requirements in distribution boards. In case of the VA NH

version, a spark gap is connected in series with the heavy-duty zinc oxide varistor with thermal monitoring and disconnection device of the V NH surge arresters. VA NH devices are used to reliably protect large-scale systems with permanent insulation monitoring. Apart from the standard visual indication by a tripping indicator, V(A) NH ... FM surge arresters feature a microswitch integrated in the NH fuse holder for remote signalling.

- Surge arrester for use in NH 00 and 1 fuse holders
- Zinc oxide varistor with monitoring device, disconnecter and integrated backup fuse (VA NH... with additional spark gap connected in series)
- Energy coordination with other arresters of the Red/Line product family
- Fault indication by tripping indicator

V NH00 (FM)

Varistor-based surge arrester with integrated backup fuse for use in NH00 fuse holders, optionally available with special indicator for remote signalling.

Type	V NH00 280	V NH00 280 FM
Part No.	900 261	900 263
SPD according to EN 61643-11 / IEC 61643-11	type 2 / class II	type 2 / class II
Max. continuous operating voltage (a.c.) (U_c)	280 V (50 / 60 Hz)	280 V (50 / 60 Hz)
Max. discharge current (8/20 μ s) (I_{max})	30 kA	30 kA
Voltage protection level (U_p)	≤ 1.5 kV	≤ 1.5 kV
Max. mains-side overcurrent protection	not required	not required
Indicator for remote signalling	—	tripping distance of 7 mm



V NH1

Varistor-based surge arrester with integrated backup fuse for use in NH1 fuse holders.

Type	V NH1 280
Part No.	900 270
SPD according to EN 61643-11 / IEC 61643-11	type 2 / class II
Max. continuous operating voltage (a.c.) (U_c)	280 V (50 / 60 Hz)
Max. discharge current (8/20 μ s) (I_{max})	30 kA
Voltage protection level (U_p)	≤ 1.5 kV
Max. mains-side overcurrent protection	not required



VA NH00 (FM)

Surge arrester based on a series-connected varistor and spark gap with integrated backup fuse; for use in NH00 fuse holders, optionally available with special indicator for remote signalling.

Type	VA NH00 280	VA NH00 280 FM
Part No.	900 262	900 264
SPD according to EN 61643-11 / IEC 61643-11	type 2 / class II	Type 2 / Class II
Max. continuous operating voltage (a.c.) (U_c)	280 V (50 / 60 Hz)	280 V (50 / 60 Hz)
Max. discharge current (8/20 μ s) (I_{max})	20 kA	20 kA
Voltage protection level (U_p)	≤ 1.5 kV	≤ 1.5 kV
Max. mains-side overcurrent protection	not required	not required
Indicator for remote signalling	—	tripping distance of 7 mm



VA NH1

Surge arrester based on a series-connected varistor and spark gap with integrated backup fuse; for use in NH1 fuse holders.

Type	VA NH1 280
Part No.	900 271
SPD according to EN 61643-11 / IEC 61643-11	type 2 / class II
Max. continuous operating voltage (a.c.) (U_c)	280 V (50 / 60 Hz)
Max. discharge current (8/20 μ s) (I_{max})	20 kA
Voltage protection level (U_p)	≤ 1.5 kV
Max. mains-side overcurrent protection	not required



DEHN protects.



DEHNrall

DR MOD 255

green: ok → red: ✘

No. 953 010

U_c 255 V (50/60 Hz)

I_n 3 kA

U_{oc} 6 kV

U_p 1,25 kV (L-N)

U_p 1,5 kV (L/N-PE)

I_{total} 5 kA

T3

Selection Chart

DIN rail	Cable duct / flush-mounted system	Socket outlets (modules)	Socket outlets (adapters)	Acoustic fault indication	Visual fault indication	Remote signalling contact	Series connection	Type	Part No.	Page
•					•		•	DR M 2P 255	953 200	104
•					•	•	•	DR M 2P 255 FM	953 205	105
•					•		•	DR M 4P 255	953 400	106
•					•	•	•	DR M 4P 255 FM	953 405	106
•					•			DR M 2P 255 SN1802	953 228	105
•					•	•		DR M 2P 255 SN1803FM	953 229	105
•					•	•		DR M 4P 255 SN1872 FM	953 406	106
•					•		•	SPS PRO	912 253	109
	•	•			•		•	DSA 230 LA	924 370	110
	•	•			•			NSM PRO TW	924 335	111
	•	•		•				STC 230	924 350	112
	•	•		•				DFL M 255	924 396	113
	•	•		•				DFL A 255	924 389	113
	•	•		•			•	DFL D 255	924 395	113
			•		•			DPRO 230	909 230	115
			•		•			DPRO 230 F	909 240	115
			•		•			SFL PRO 6X	909 250	116
			•		•			SFL PRO 6X 19"	909 251	116



DEHNrail modular



For protecting the power supply circuits of industrial electronics equipment against transients in switchgear cabinets. For installation in conformity with the lightning protection zone concept at the boundaries from 1 – 2 and higher.

The modular devices of the DEHNrail M product family stand out due to their high-performance parameters and straightforward Red/Line design. The devices combine safety and ease of use in a single module. The low voltage protection level and the comprehensive common and differential mode protection make them ideal for protecting terminal equipment in industrial electronics environments. The input and output terminals for series connection and the protective circuit designed for high load currents underline this concept.

The very compact design of the DEHNrail M surge arresters includes the fault-proof Y protective circuit and a combined SPD monitoring and disconnection device.

The base part and protection module are coded to guard against installing an incorrect module.

The unique module locking system of the DEHNrail M product family fixes the protection module to the base part. Neither vibration during transport nor the electrodynamic forces of discharge can loosen the connection.

- Two-pole surge arrester consisting of a base part and a plug-in protection module
- High discharge capacity due to heavy-duty zinc oxide varistor / spark gap combination
- Energy coordination with other arresters of the Red/Line product family
- Operating state / fault indication by green / red indicator flag in the inspection window
- Narrow (modular) design according to DIN 43880
- Easy replacement of protection modules due to module locking system with module release button
- Vibration and shock-tested according to EN 60068-2

DEHNrail M 2P ...: Two-pole surge arrester consisting of a base part and a plug-in protection module

DEHNrail M 2P ... FM: With remote signalling contact for monitoring device (floating changeover contact)

In the event of the protective circuit being overloaded, the protection modules can be easily replaced without tools by simply pressing the module release button.

In addition to the standard visual indication with green and red indicator flags, DEHNrail M ... FM devices feature a three-pole remote signalling terminal. As the remote signalling contact is designed as a floating changeover contact, the remote signal can, depending on the circuit concept, be used as a make or break contact.



DEHNrail M 2P ...

Two-pole surge arrester consisting of a base part and a plug-in protection module.

General Information:	
SPD according to EN 61643-11 / IEC 61643-11	type 3 / class III
Max. mains-side overcurrent protection	25 A gG or B 25 A
Approvals	KEMA, VDE, UL, CSA

Type DR M 2P ...	30	60	75
Part No.	953 201	953 202	953 203
Max. continuous operating voltage (a.c.) (U _c)	30 V (50 / 60 Hz)	60 V (50 / 60 Hz)	75 V (50 / 60 Hz)
Max. continuous operating voltage (d.c.) (U _c)	30 V	60 V	75 V
Nominal discharge current (8/20 μs) (I _n)	1 kA	1 kA	2 kA
Total discharge current (8/20 μs) [L+N-PE] (I _{total})	2 kA	2 kA	4 kA
Voltage protection level [L-N] / [L/N-PE] (U _p)	≤ 180 / ≤ 630 V	≤ 350 / ≤ 730 V	≤ 400 / ≤ 730 V

Type DR M 2P ...	150	255
Part No.	953 204	953 200
Max. continuous operating voltage (a.c.) (U _c)	150 V (50 / 60 Hz)	255 V (50 / 60 Hz)
Max. continuous operating voltage (d.c.) (U _c)	150 V	255 V
Nominal discharge current (8/20 μs) (I _n)	2 kA	3 kA
Total discharge current (8/20 μs) [L+N-PE] (I _{total})	4 kA	5 kA
Voltage protection level [L-N] / [L/N-PE] (U _p)	≤ 640 / ≤ 800 V	≤ 1250 / ≤ 1500 V



DEHnrail M 2P ... FM

Two-pole surge arrester consisting of a base part and a plug-in protection module; with floating remote signalling contact.

General Information:			
SPD according to EN 61643-11 / IEC 61643-11	type 3 / class III		
Max. mains-side overcurrent protection	25 A gG or B 25 A		
Approvals	KEMA, VDE, UL, CSA		
Type of remote signalling contact	changeover contact		
Type DR M 2P ...	30 FM	60 FM	75 FM
Part No.	953 206	953 207	953 208
Max. continuous operating voltage (a.c.) (U_c)	30 V (50 / 60 Hz)	60 V (50 / 60 Hz)	75 V (50 / 60 Hz)
Max. continuous operating voltage (d.c.) (U_c)	30 V	60 V	75 V
Nominal discharge current (8/20 μ s) (I_n)	1 kA	1 kA	2 kA
Total discharge current (8/20 μ s) [L+N-PE] (I_{total})	2 kA	2 kA	4 kA
Voltage protection level [L-N] / [L/N-PE] (U_p)	$\leq 180 / \leq 630$ V	$\leq 350 / \leq 730$ V	$\leq 400 / \leq 730$ V
Type DR M 2P ...	150 FM	255 FM	
Part No.	953 209	953 205	
Max. continuous operating voltage (a.c.) (U_c)	150 V (50 / 60 Hz)	255 V (50 / 60 Hz)	
Max. continuous operating voltage (d.c.) (U_c)	150 V	255 V	
Nominal discharge current (8/20 μ s) (I_n)	2 kA	3 kA	
Total discharge current (8/20 μ s) [L+N-PE] (I_{total})	4 kA	5 kA	
Voltage protection level [L-N] / [L/N-PE] (U_p)	$\leq 640 / \leq 800$ V	$\leq 1250 / \leq 1500$ V	



DEHnrail M 2P SN1802

Two-pole surge arrester consisting of a base part and a plug-in protection module. Can be used in systems with a load current up to 32 A.

Type DR M 2P ...	255 SN1802
Part No.	953 228
SPD according to EN 61643-11 / IEC 61643-11	type 3 / class III
Max. continuous operating voltage (a.c.) (U_c)	255 V (50 / 60 Hz)
Max. continuous operating voltage (d.c.) (U_c)	255 V
Nominal discharge current (8/20 μ s) (I_n)	3 kA
Total discharge current (8/20 μ s) [L+N-PE] (I_{total})	5 kA
Voltage protection level [L-N] / [L/N-PE] (U_p)	$\leq 1250 / \leq 1500$ V
Max. mains-side overcurrent protection	32 A gG or B 32 A

Protection module upon request



DEHnrail M 2P SN1803FM

Two-pole surge arrester consisting of a base part and a plug-in protection module; with floating remote signalling contact. Can be used in systems with a load current up to 32 A.

Type DR M 2P ...	255 SN1803FM
Part No.	953 229
SPD according to EN 61643-11 / IEC 61643-11	type 3 / class III
Max. continuous operating voltage (a.c.) (U_c)	255 V (50 / 60 Hz)
Max. continuous operating voltage (d.c.) (U_c)	255 V
Nominal discharge current (8/20 μ s) (I_n)	3 kA
Total discharge current (8/20 μ s) [L+N-PE] (I_{total})	5 kA
Voltage protection level [L-N] / [L/N-PE] (U_p)	$\leq 1250 / \leq 1500$ V
Max. mains-side overcurrent protection	32 A gG or B 32 A
Type of remote signalling contact	changeover contact

Protection module upon request





DEHNrail modular, multipole



For protecting the power supply circuits of industrial electronics equipment against transients in switchgear cabinets. For installation in conformity with the lightning protection zone concept at the boundaries from 1 – 2 and higher.

The modular four-pole DEHNrail M 4P ... (FM) surge arresters are specifically developed for protecting three-phase industrial electronics terminal equipment. Adapted to this kind of environment, the arresters with the Red/Line design are suitable for 35 mm DIN rails. The low voltage protection level and the comprehensive common and differential mode protection are characteristic of DEHNrail M 4P ... (FM). To provide optimal low voltage protection levels for the terminal equipment to be protected, the device features input and output terminals for series connection. DEHNrail M 4P ... (FM) devices ideally adapt to the cable run upstream of the terminal equipment. Therefore, no additional terminal blocks for outgoing cables are required. The compact design incorporates the tried and tested disconnecter. It disconnects an overloaded arrester circuit without interrupting the supply circuit.

The base part and protection module are coded to guard against installing the incorrect module.

The unique module locking system of the DEHNrail M family fixes the protection modules to the base part. Neither vibrations during transport nor the electrodynamic forces of discharge can loosen the connection.

- Four-pole surge arrester consisting of a base part and a plug-in protection module
- High discharge capacity due to heavy-duty zinc oxide varistor / spark gap combination
- Energy coordination with other arresters of the Red/Line product family
- Operating state / fault indication by green / red indicator flag in the inspection window
- Easy replacement of protection modules without tools due to module locking system with module release button
- Nominal load currents up to 25 A
- Vibration and shock-tested in accordance with EN 60068-2

DEHNrail M 4P ...: Four-pole surge arrester consisting of a base part and a plug-in protection module

DEHNrail M 4P ... FM: With remote signalling contact for monitoring device (floating changeover contact)

In the event of the protective circuit, which is rated for high load currents up to 25 A, being overloaded, the protection modules can be easily replaced without tools by simply pressing the module release button.

Apart from the standard visual indication with green and red indicator flags, DEHNrail M 4P ... FM devices feature a three-pole remote signalling terminal. As the remote signalling contact is designed as a floating changeover contact, the remote signal can, depending on the circuit concept, be used as a make or break contact.



DEHN rail M 4P ... (FM)

Four-pole surge arrester consisting of a base part and a plug-in protection module for 230/400 V systems; FM version with floating remote signalling contact.

Type DR M 4P ...	255	255 FM
Part No.	953 400	953 405
SPD according to EN 61643-11 / IEC 61643-11	type 3 / class III	type 3 / class III
Max. continuous operating voltage (a.c.) (U_C)	255 / 440 V (50 / 60 Hz)	255 / 440 V (50 / 60 Hz)
Nominal discharge current (8/20 μ s) (I_n)	3 kA	3 kA
Total discharge current (8/20 μ s) [L1+L2+L3+N-PE] (I_{total})	8 kA	8 kA
Voltage protection level [L-N] / [L/N-PE] (U_P)	$\leq 1000 / \leq 1500$ V	$\leq 1000 / \leq 1500$ V
Max. mains-side overcurrent protection	25 A gG or B 25 A	25 A gG or B 25 A
Approvals	KEMA, VDE	KEMA, VDE
Type of remote signalling contact	—	changeover contact

DEHNrail M 4P SN1872 FM

Four-pole surge arrester consisting of a base part and a plug-in protection module; with floating remote signalling contact. Can be used in systems with a fusing up to 32 A.

Type DR M 4P ...	255 SN1872 FM
Part No.	953 406
SPD according to EN 61643-11 / IEC 61643-11	type 3 / class III
Max. continuous operating voltage (a.c.) (U_C)	255 / 440 V (50 / 60 Hz)
Nominal discharge current (8/20 μ s) (I_n)	3 kA
Total discharge current (8/20 μ s) [L1+L2+L3+N-PE] (I_{total})	8 kA
Voltage protection level [L-N] / [L/N-PE] (U_P)	$\leq 1000 / \leq 1500$ V
Max. mains-side overcurrent protection	32 A gG oder B 32 A
Type of remote signalling contact	changeover contact





Protection Module for DEHnrail modular

- High discharge capacity due to heavy-duty zinc oxide varistor / spark gap combination
- High reliability due to "Thermo Dynamic Control" disconnecter with dual monitoring
- Energy coordination with other arresters of the Red/Line product family
- Easy replacement of protection modules without tools due to module locking system with module release button
- Operating state / fault indication by green / red indicator flag in the inspection window
- The plug-in protection module can be replaced without the need to de-energise and without removing the distribution board cover
- Vibration and shock-tested in accordance with EN 60068-2



For protecting the power supply circuits of industrial electronics equipment against surges in switchgear cabinets. For installation in conformity with the lightning protection zone concept at the boundaries from 1 – 2 and higher.

DEHnrail MOD ...: For all types of two-pole DEHnrail M 2P ... surge arresters

DEHnrail MOD 4P...: For all types of four-pole DEHnrail M 4P ... surge arresters

Protection Module for DEHnrail M 2P

Protection module with integrated Y protection circuit.

Type DR MOD ...	30	60	75
Part No.	953 011	953 012	953 013
Nominal discharge current (8/20 μ s) (I_n)	1 kA	1 kA	2 kA
Total discharge current (8/20 μ s) [L+N-PE] (I_{total})	2 kA	2 kA	4 kA
Max. continuous operating voltage (a.c.) (U_c)	30 V	60 V	75 V

Type DR MOD ...	150	255
Part No.	953 014	953 010
Nominal discharge current (8/20 μ s) (I_n)	2 kA	3 kA
Total discharge current (8/20 μ s) [L+N-PE] (I_{total})	4 kA	5 kA
Max. continuous operating voltage (a.c.) (U_c)	150 V	255 V



Protection Module for DEHnrail M 4P

Four-pole protection module with integrated protective circuit.

Type DR MOD ...	4P 255	4P 255 SN1871
Part No.	953 020	953 021
Nominal discharge current (8/20 μ s) (I_n)	3 kA	3 kA
Total discharge current (8/20 μ s) [L+N-PE] (I_{total})	8 kA	8 kA
Max. continuous operating voltage (a.c.) (U_c)	255 V	255 V





Mains Filter

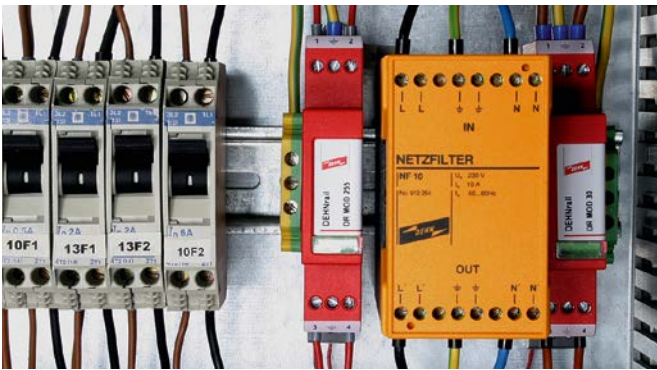

- Protection of sensitive industrial electronics equipment against balanced and unbalanced high-frequency interference
- For use in combination with surge protective devices, e.g. DEHNrail M 2P 255
- Easy installation on DIN rails in switchgear cabinets

The NF 10 mains filter ideally complements surge protective devices for industrial terminal equipment. This DIN rail mounted device is perfectly suited for installation downstream of surge protective devices (e.g. DEHNrail M 2P 255). In addition to surge protection, protection against balanced and unbalanced high-frequency interference is provided. The

separate input and output terminals of the mains filter ensure optimal protection of the equipment to be protected. Apart from surge protection, the mains filter also fulfils electromagnetic compatibility requirements in control and plant construction.

NF 10

Mains filter for protection against balanced and unbalanced interferences.



Type	NF 10
Part No.	912 254
Nominal voltage (a.c.) (U_N)	230 V
Nominal load current (a.c.) (I_N)	10 A
Attenuation for $f = 1$ MHz, balanced	> 64 dB
Attenuation for $f = 1$ MHz, unbalanced	> 69 dB



SPS Protector

- Combination of surge protection and filter
- Surge protection with monitoring device and disconnector
- Interference suppressor filter for protecting sensitive industrial electronics equipment against balanced and unbalanced high-frequency interference
- Integrated in a shielded enclosure
- Visual operating state indication (green) and floating remote signalling contact (break contact) for fault indication



For protecting the power supply circuits of industrial electronics equipment (e.g. programmable logic controls (PLCs)) against transients and high-frequency interference voltages. For installation in conformity with the lightning protection zone concept at the boundaries from 1 – 2 and higher.

SPS Protector: Two-pole surge arrester with interference suppressor filter



The SPS Protector combines surge protection and interference suppressor filter in a compact device. This makes it ideal for protecting sensitive terminal equipment of industrial automation systems (e.g. programmable logic controls (PLCs)). The coordinated surge protection and filter functions complement one another and prevent core saturation of the filter in the event of high-level transients. The separate input and output terminals provide optimal protection for the device to be protected. The metal enclosure of the SPS Protector ensures that high-frequency interferences are discharged without interfering with other devices in the immediate vicinity. The compact design of the SPS Protector already houses the proven disconnector. In case of overload, it disconnects the arrester without interrupting the power supply circuit. Apart from the green indicator light, SPS Protectors also feature a remote signalling contact.

SPS Protector

Surge arrester with interference suppressor filter for single-phase 230 V TT and TN systems; with floating remote signalling contact.

Type	SPS PRO
Part No.	912 253
SPD according to EN 61643-11 / IEC 61643-11	type 3 / class III
Max. continuous operating voltage (a.c.) (U_c)	255 V (50 / 60 Hz)
Nominal load current (a.c.) (I_L)	3 A
Nominal discharge current (8/20 μ s) (I_n)	3 kA
Total discharge current (8/20 μ s) [L+N-PE] (I_{total})	5 kA
Voltage protection level [L-N] / [L/N-PE] (U_P)	≤ 800 / ≤ 1000 V
Type of remote signalling contact	break contact





DEHNsafe



For protecting electronic devices against surges. For installation in electrical installation systems, e.g. cable ducts or flush-type boxes. For installation in conformity with the lightning protection zone concept at the boundaries from 1 – 2 and higher.

- Two-pole surge protective device for 230 V terminal equipment
- For use in flush-type boxes and cable ducts
- Enhanced safety due to fault-proof Y protective circuit
- Multiple visual indicator
- Programmable acoustic function
- Terminals for series connection
- Independent of the socket outlet design

DEHNsafe 230 LA: Surge protective device for use in cable ducts

DEHNsafe surge arresters particularly stand out due to their flexible application options. Thanks to their small mounting depth of only 31 mm, the two-pole surge protective devices for 230 V terminal equipment can be installed both in cable ducts and in flat flush-type boxes. DEHNsafe incorporates a monitoring device and a thermal disconnecter. In addition to a visual operating state indicator, the device features a programmable acoustic fault indicator which can be programmed for three different operating states:

- Acoustic fault indication,
- Test function,
- Muting of the acoustic signal.

DEHNsafe surge arresters use a triple TAE cover from any switch range manufacturer as a cover, thus adapting perfectly to any socket outlet design.

The double terminals for L, N and PE allow series connection so that the surge protection is parallel to the circuit to be protected. For this reason, DEHNsafe does not necessarily interrupt the circuit to be protected in case of overload. A green and a red LED allows the user to visually inspect the DEHNsafe.



DEHNsafe

Surge protective device for use in cable ducts and flush-type boxes. For single-phase 230 V TT and TN systems.

Type	DSA 230 LA
Part No.	924 370
SPD according to EN 61643-11 / IEC 61643-11	type 3 / class III
Max. continuous operating voltage (a.c.) (U_c)	255 V (50 / 60 Hz)
Nominal discharge current (8/20 μ s) (I_n)	3 kA
Total discharge current (8/20 μ s) [L+N-PE] (I_{total})	5 kA
Voltage protection level [L-N] / [L/N-PE] (U_p)	≤ 1250 / ≤ 1500 V
Max. mains-side overcurrent protection	B 16 A
Fault indication	red light + acoustic signal
Operating state indication	green light



Accessories for DEHNsafe



Central Covering Plate

Single unit, alpha exclusive.

Type	ZAP STW
Part No.	924 329
Colour	studio white



Cover Frame

Single unit, alpha exclusive.

Type	AR1 STW
Part No.	924 328
Colour	studio white



NSM Protector

- Surge protection with monitoring device and disconnector
- Enhanced safety due to fault-proof Y protective circuit
- Visual operating state (green) and fault indication (red)
- With retaining ring (diameter of 60 mm) for installation in switch boxes with a diameter of 60 mm and a depth of 40 mm



For protecting electronic equipment against surges. Earthed socket outlet with surge protective circuit for installation in electrical installation systems. For installation in conformity with the lightning protection zone concept at the boundaries from 1 – 2 and higher. German utility patent.

NSM Protector: Earthed socket outlet with integrated surge protection

The devices of the NSM Protector family combine surge protection and earthed socket outlet in a single device. The two-pole surge arresters are specifically designed for protecting electronic consumers in final circuits. Their very compact design incorporates the approved disconnector which disconnects overloaded surge arresters without interrupting the supply circuit. The low voltage protection level as well as the comprehensive

common and differential mode protection are typical of the devices of the NSM Protector family. The fault-proof Y protective circuit ensures safety even if the phase and neutral conductor in final circuits cannot be identified. The integrated disconnector ensures reliability of devices and installations. The standard green and red LEDs indicate the operating state of the surge protective devices.

NSM PRO

Socket outlet with integrated surge protection for single-phase 230 V TT and TN systems.

Type	NSM PRO TW
Part No.	924 335
SPD according to EN 61643-11 / IEC 61643-11	type 3 / class III
Max. continuous operating voltage (a.c.) (U_c)	255 V (50 / 60 Hz)
Nominal discharge current (8/20 μ s) (I_n)	3 kA
Total discharge current (8/20 μ s) [L+N-PE] (I_{total})	5 kA
Voltage protection level [L-N] / [L/N-PE] (U_p)	≤ 1250 / ≤ 1500 V
Max. mains-side overcurrent protection	B 16 A
Fault indication	red light
Operating state indication	green light
DELTA Profil line	titanium white



Accessories for NSM Protector

AR1 Cover Frame

Single unit, suitable for NSM Protector.

Type	AR1 TW
Part No.	924 336
Type	DELTA profil, titanium white





STC Module

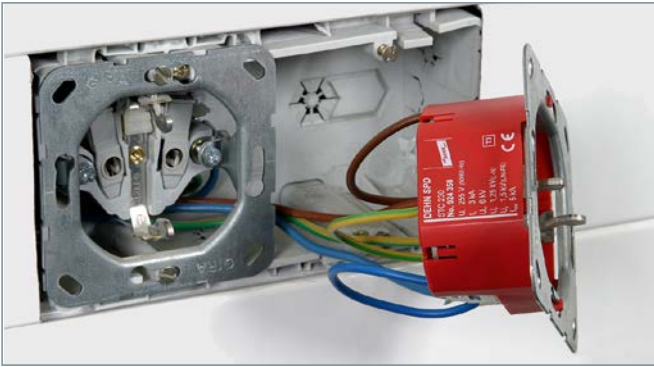

For protecting electronic devices against surges. For use with standard earthed socket outlets. For installation in conformity with the lightning protection zone concept at the boundaries from 1 – 2 and higher.

- Two-pole surge arrester with monitoring device and disconnecter
- Enhanced safety due to fault-proof Y protective circuit
- Acoustic fault indication
- For installation in standard earthed socket outlets
- Independent of the socket outlet design
- Plastic snap-on retaining ring for easy installation in already mounted socket outlets

STC 230: Snap-on module for standard earthed socket outlets

The popular two-pole STC surge arrester can be fitted inconspicuously on the rear side of many standard earthed socket outlets. The STC surge protection module thus adapts to every type of socket outlet. The plastic snap-on retaining ring allows easy installation even in already mounted earthed socket outlets. In addition to a thermal disconnecter, the protective device features an acoustic fault indication. As the surge protection module is installed in parallel to the socket outlet, the power supply of the connected consumers remains uninterrupted, even if the surge arrester is overloaded.

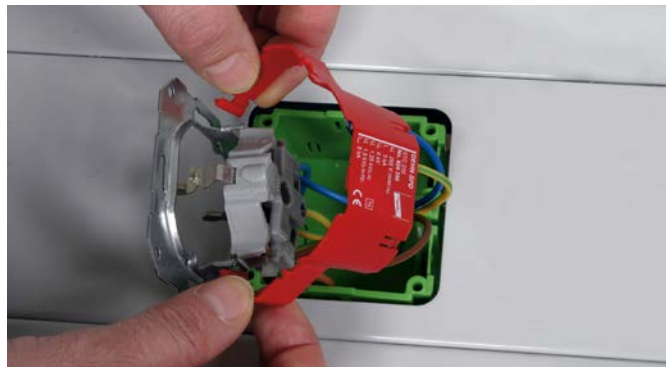

STC 230

Two-pole surge arrester for single-phase 230 V TT and TN systems is snapped on earthed socket outlets.

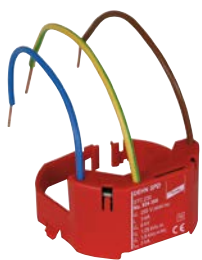

Type	STC 230
Part No.	924 350
SPD according to EN 61643-11 / IEC 61643-11	type 3 / class III
Max. continuous operating voltage (a.c.) (U_c)	255 V (50 / 60 Hz)
Nominal discharge current (8/20 μ s) (I_n)	3 kA
Total discharge current (8/20 μ s) [L+N-PE] (I_{total})	5 kA
Voltage protection level [L-N] / [L/N-PE] (U_p)	≤ 1250 / ≤ 1500 V
Max. mains-side overcurrent protection	B 16 A
Fault indication	acoustic signal on



DEHNflex

- Two-pole surge arrester with monitoring device and disconnecter
- Enhanced safety due to fault-proof Y protective circuit
- Acoustic fault indication
- Compact design
- For use in flush-mounted systems, cable ducts and flush-type boxes

DEHNflex M: Compact design; for use in cable duct systems and flush-type boxes

DEHNflex A: For use in any cable duct systems or flush-type boxes; with test function

DEHNflex D: Like DEHNflex A, but for series connection of several socket outlets



For protecting electronic equipment against surges. For installation in electrical installation systems, e.g. flush-mounted systems, cable ducts and flush-type boxes. German utility patent for DEHNflex A / ... D. For installation in conformity with the lightning protection zone concept at the boundaries from 1 – 2 and higher.

As the name suggests, the DEHNflex family offers almost unlimited application options. Being two-pole surge arresters, the compact modules are ideally suited for protecting electronic consumers in final circuits. The design was adapted to the most common places of installation, that is cable ducts and flush-type boxes. DEHNflex devices clearly prove that small and compact dimensions do not necessarily mean low performance.

The fault-proof Y protective circuit always ensures safety even if the phase and neutral conductor cannot be identified. Apart from the powerful Y circuit, the compact enclosure also houses a disconnecter and an acoustic fault indicator. Be it in cable ducts, flush-mounted systems, branching boxes or device casings – DEHNflex is always installed in the right place close to terminal equipment.

DEHNflex M

Surge arrester for single-phase 230 V TT and TN systems for use in all installation systems of terminal equipment; compact dimensions.

Type DFL ...	M 255
Part No.	924 396
SPD according to EN 61643-11 / IEC 61643-11	type 3 / class III
Max. continuous operating voltage (a.c.) (U_c)	255 V (50 / 60 Hz)
Nominal discharge current (8/20 μ s) (I_n)	1.5 kA
Total discharge current (8/20 μ s) [L+N-PE] (I_{total})	3 kA
Voltage protection level [L-N] / [L/N-PE] (U_p)	≤ 1250 / ≤ 1500 V
Max. mains-side overcurrent protection	B 16 A
Fault indication	acoustic signal on
Dimensions	30 x 50 x 11 mm

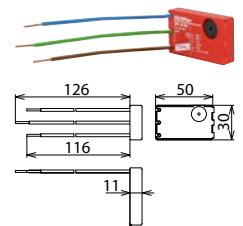

DEHNflex A

Surge arrester for single-phase 230 V TT and TN systems for use in all installation systems of terminal equipment; with test function; compact dimensions.

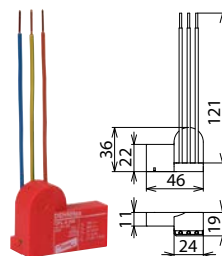

Type DFL ...	A 255
Part No.	924 389
SPD according to EN 61643-11 / IEC 61643-11	type 3 / class III
Max. continuous operating voltage (a.c.) (U_c)	255 V (50 / 60 Hz)
Nominal discharge current (8/20 μ s) (I_n)	3 kA
Total discharge current (8/20 μ s) [L+N-PE] (I_{total})	5 kA
Voltage protection level [L-N] / [L/N-PE] (U_p)	≤ 1250 / ≤ 1500 V
Max. mains-side overcurrent protection	B 16 A
Fault indication	acoustic signal on
Dimensions	36 x 46 x 19 mm

DEHNflex D

Surge arrester for single-phase 230 V TT and TN systems for use in all installation systems of terminal equipment; allows series connection; with test function; compact dimensions.

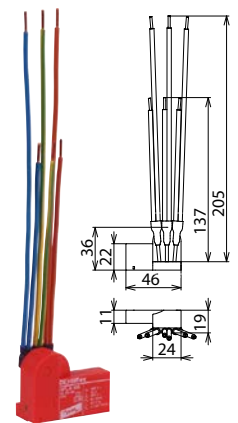

Type DFL ...	D 255
Part No.	924 395
SPD according to EN 61643-11 / IEC 61643-11	type 3 / class III
Max. continuous operating voltage (a.c.) (U_c)	255 V (50 / 60 Hz)
Nominal discharge current (8/20 μ s) (I_n)	3 kA
Total discharge current (8/20 μ s) [L+N-PE] (I_{total})	5 kA
Voltage protection level [L-N] / [L/N-PE] (U_p)	≤ 1250 / ≤ 1500 V
Max. mains-side overcurrent protection	B 16 A
Fault indication	acoustic signal on
Dimensions	36 x 46 x 19 mm



VC 280 2

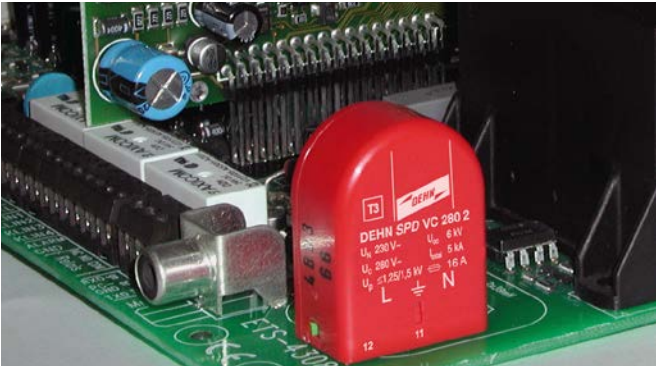

VC 280 2 protects electronic equipment against surges. It is installed in the enclosure or directly in the device to be protected in conformity with the lightning protection zone concept at the boundaries from 1 – 2 and higher. German utility patent.

- Two-pole surge arrester with monitoring device and disconnecter
- Complete surge protection for devices supplied by a.c. voltage
- Enhanced safety due to fault-proof Y protective circuit
- Floating remote signalling contact (break contact) with test option for the fault indicator
- For installation on printed circuit boards

VC 280 2: Mains module with integrated surge protection for installation in the terminal device to be protected

VC 280 2 surge arresters are small, but no less complex. The two-pole module incorporates a fault-proof Y protective circuit, a monitoring and disconnection device as well as a floating remote signalling contact, thus ensuring compact dimensions and maximum safety. The surge arresters

even feature an integrated test option for the fault indicator. VC 280 2 reliably protects electronic equipment against overvoltage. The solder pins of VC 280 2 surge arresters make it possible to install them directly on the PCBs of the device to be protected.

VC 280 2

Mains module with integrated surge protection and floating break contact for installation in the terminal equipment to be protected.



Type	VC 280 2
Part No.	900 471
SPD according to EN 61643-11 / IEC 61643-11	type 3 / class III
Max. continuous operating voltage (a.c.) (U_C)	280 V (50 / 60 Hz)
Nominal discharge current (8/20 μ s) (I_n)	3 kA
Total discharge current (8/20 μ s) [L+N-PE] (I_{total})	5 kA
Voltage protection level [L-N] / [L/N-PE] (U_P)	$\leq 1250 / \leq 1500$ V
Max. mains-side overcurrent protection	B 16 A
Fault indication	remote signalling contact (break contact)



DEHNprotector

- Surge protection with monitoring device and disconnector
- Visual operating state (green) and fault indication (red)
- Mains filter (DEHNpro 230 F Protector only)
- Enhanced safety due to fault-proof Y protective circuit



The adapter protects the power supply circuits of electronic equipment against transients and high-frequency interference voltages (DEHNpro 230 F Protector). For installation in conformity with the lightning protection zone concept at the boundaries from 1 – 2 and higher.

DEHNpro 230: Protection of terminal equipment

DEHNpro 230 F: Protection of terminal equipment with mains filter

The adapters with integrated surge protection of the DEHNpro family protect electronic consumers connected to final circuits from overvoltage. An interference suppressor filter with a balancing and unbalancing effect has been integrated in the powerful surge protective circuit of DEHNpro 230 F Protectors. This combination of surge protection and filter prevents a core saturation of the filter in case of high-level transients. The nominal current carrying capability of 16 A (DEHNpro 230 Protector) and 10 A (DEHNpro 230 F Protector) allows flexible use of these devices in final circuits. The fault-proof Y circuit ensures protection even if the phase and neutral conductor in standard earthed socket outlets cannot be identified.

The integrated disconnector makes a further contribution to device and system safety. The standard green and red LEDs indicate the operating state of the surge protective devices.

The modern design and use of high quality materials make the DEHNpro devices both safe and stylish. This means that the DEHNpro devices fit perfectly into their application environment. Starting at the power socket, they create the right ambience for connecting the latest communication and media technology. The curved enclosure surfaces and the smooth surface structure of the DEHNpro devices ensure that they lose none of their original aesthetic appeal even after years of use.

Further adapters with integrated surge protection for protecting the power supply circuit and the data interface of an electronic device can be found on page 216 – 217.

DPRO 230 Protector

Adapter with integrated surge protection and child lock.

Type DPRO ...	230
Part No.	909 230
SPD according to EN 61643-11 / IEC 61643-11	type 3 / class III
Max. continuous operating voltage (a.c.) (U_c)	255 V (50 / 60 Hz)
Nominal discharge current (8/20 μ s) (I_n)	3 kA
Total discharge current (8/20 μ s) [L+N-PE] (I_{total})	5 kA
Voltage protection level [L-N] / [L/N-PE] (U_p)	≤ 1250 / ≤ 1500 V
Max. mains-side overcurrent protection	B 16 A
Fault indication	red light
Operating state indication	green light



DPRO 230 F Protector

Surge protection for terminal devices with integrated mains filter.

Type DPRO ...	230 F
Part No.	909 240
SPD according to EN 61643-11 / IEC 61643-11	type 3 / class III
Max. continuous operating voltage (a.c.) (U_c)	255 V (50 / 60 Hz)
Nominal discharge current (8/20 μ s) (I_n)	3 kA
Total discharge current (8/20 μ s) [L+N-PE] (I_{total})	5 kA
Voltage protection level [L-N] / [L/N-PE] (U_p)	≤ 1250 / ≤ 1500 V
Max. mains-side overcurrent protection	B 16 A
Fault indication	red light
Operating state indication	green light





SFL Protector



- Surge protection with monitoring device and disconnecter
- Interference suppressor filter
- Enhanced safety due to fault-proof Y protective circuit
- Mains switch with operating state indication (SFL PRO 6X only)
- 2 m connection cable for flexible use in a wide range of applications
- Visual operating state (green) and fault indicator (red)

Multiple socket outlet for protecting the power supply circuits of electronic equipment against transients and high-frequency interference voltages. For installation in conformity with the lightning protection zone concept at the boundaries from 1 – 2 and higher.

SFL PRO 6X: Surge protective multiple socket outlet with interference suppressor filter

SFL PRO 6X 19": Surge protective multiple socket outlet with mains filter for 482.6 mm (19 inch) data cabinets

The SFL Protector surge arrester complements the wide range of Red/Line surge protective devices. The combination of surge protection and mains filter makes the six-way socket outlet a powerful device for protecting electronic consumers in final circuits. The harmonised surge protection and filter functions complement one another and prevent core saturation of the filter in case of high-level transients. The integrated mains filter is optimised for protection against balanced and unbalanced high-frequency interferences. The nominal current carrying capability of 16 A allows flexible use of these devices in final circuits.

The fault-proof Y protection circuit ensures protection even if the phase and neutral conductor in standard earthed socket outlets cannot be identified. The standard green and red LEDs indicate the operating state of the surge protective device.

The SFL PRO 6X 19" has been specifically developed for use in network cabinets and therefore provides optimal protection for terminal equipment in this critical field of application.



SFL PRO 6X

Surge protective multiple socket outlet with mains filter.



Type SFL PRO ...	6X
Part No.	909 250
SPD according to EN 61643-11 / IEC 61643-11	type 3 / class III
Max. continuous operating voltage (a.c.) (U_c)	255 V (50 / 60 Hz)
Nominal discharge current (8/20 μ s) (I_n)	3 kA
Total discharge current (8/20 μ s) [L+N-PE] (I_{total})	5 kA
Voltage protection level (U_p)	≤ 1.5 kV
Max. mains-side overcurrent protection	B 16 A
Number of socket outlets	6

SFL PRO 19"

Surge protective multiple socket outlet with mains filter for 482.6 mm (19 inches) data cabinets.



Type SFL PRO ...	6X 19"
Part No.	909 251
SPD according to EN 61643-11 / IEC 61643-11	type 3 / class III
Max. continuous operating voltage (a.c.) (U_c)	255 V (50 / 60 Hz)
Nominal discharge current (8/20 μ s) (I_n)	3 kA
Total discharge current (8/20 μ s) [L+N-PE] (I_{total})	5 kA
Voltage protection level (U_p)	≤ 1.5 kV
Max. mains-side overcurrent protection	B 16 A
Number of socket outlets	6



DEHNdetect

Lightning current measuring system

- Prevention of subsequent damage
- Reduction of maintenance / repair costs
- Reduction of downtime

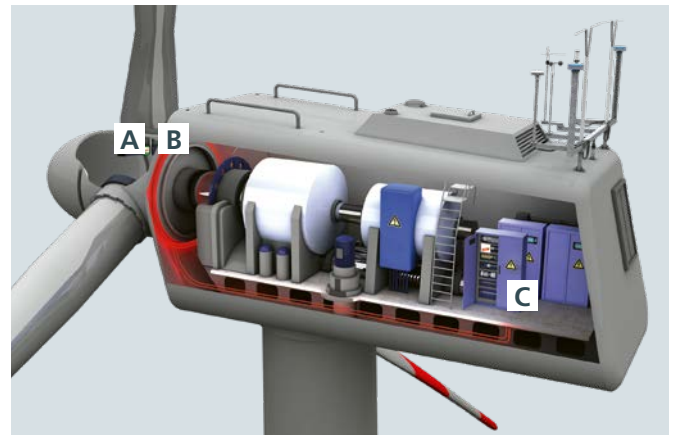

DEHNdetect consists of:

- A** Up to 3 blade detection units
- B** Measuring coil ICC IMP
- C** Data logger and integrator

NEW

Also suitable for retrofitting!

The lightning current measuring system DEHNdetect is a future-oriented system for measuring long stroke and impulse currents caused by lightning strikes to very high structures such as wind turbines. In particular, the impact of lightning-induced long stroke currents on the structure at the point of strike is often underestimated. During the discharge process which takes up to a second, an extremely high charge Q may occur, subjecting the mechanical parts of the wind turbine, e.g. the rotor blades, to heavy loads. The measuring coil DDT ICC IMP_xx precisely measures the long stroke and impulse currents. DEHN provides the measuring coil in different lengths to ensure flexible positioning in different types of wind turbines. To facilitate targeted maintenance in the affected rotor blade after a lightning strike, DEHN recommends using the blade detection unit DDT BDU which sends a signal to the DDT DL data logger via a radio link when the rotor blade is struck. There are two different lightning current detection thresholds, 100 A and 5 kA. The blade detection unit can be mounted in the rotor blade using the enclosed holder. The data logger DDT DL is the core of the system. It processes the measured and detected signals and makes them available via LTE, Ethernet or Modbus TCP. As an

alternative to integrating the data in an existing SCADA system via Modbus TCP, DEHN offers a user-friendly, cloud-based platform for clearly displaying the measurement results and managing all lightning current measurement systems. The measurement results such as impulse current, long stroke current, charge, specific energy, rise time and time stamp are displayed in this web-based application. In addition, the entire current curve of a lightning event can be displayed and evaluated or, e.g., the trigger threshold of the coils can be changed by way of remote parameterisation. Adding further users, e.g. service personnel, is quick and easy via the user administration. To ensure convenient monitoring of the devices, an e-mail can be automatically sent to an authorised group of people in case of a lightning event. Due to the modular design of DEHNdetect, the system can be configured to meet specific requirements and individually assembled. The various extension options can be put together quickly and smoothly via a WEB configurator. DEHNdetect makes lightning-fast response possible so that lengthy downtime and repair costs, as well as subsequent damage, can be avoided. This increases the economic efficiency of wind turbines allowing them to reliably generate power - today and tomorrow.

Data logger DDT DL

Type DDT ...	DL
Part No.	915 000 NEW
Voltage supply	24 V DC / ± 10 %
Measuring range (impulse current)	500 A - 250 kA
Measuring range (long stroke current)	60 A - 2.5 kA
Digital outputs	2 (24 V / 10 mA)
Communication	via LTE, Ethernet, Modbus TCP
Communication with blade detection unit	via ZigBee 2.4 GHz
For mounting on	35 mm DIN rail according to EN 60715



Data logger DDT DL TCP

Type DDT ...	DL TCP
Part No.	915 001 NEW
Voltage supply	24 V DC / ± 10 %
Measuring range (impulse current)	500 A - 250 kA
Measuring range (long stroke current)	60 A - 2.5 kA
Digital outputs	2 (24 V / 10 mA)
Communication	via Ethernet, Modbus TCP
Communication with blade detection unit	via ZigBee 2.4 GHz
For mounting on	35 mm DIN rail according to EN 60715



NEW



A Blade detection unit DDT BDU

Type DDT ...	BDU
Part No.	915 051 <small>NEW</small>
Voltage supply	battery (3.6 V AA), service life min. 5 years
Trigger level (I _{cc})	approx. 100 A
Trigger level (I _{imp})	approx. 5 kA (10/350 µs)
Installation	via glueing, clamping
Communication with data logger	via ZigBee

B Measuring coil DDT ICC

NEW



Type DDT ...	ICC IMP
Part No.	915 1xx <small>NEW</small>
Measuring coils	
Size	up to 20 m
Measuring range (impulse current)	500 A - 250 kA
Measuring range (long stroke current)	60 - 2.5 kA
Accuracy	5 %
For mounting on	the relevant wind turbine
Measuring integrator	
Connection to the measuring coils	via BNC cable ^{*)}
Connection to the data logger	via SUB-D cable ^{*)}
Accuracy (impulse current)	5 % (at 2.5 kA - 250 kA), 10 % (at 500 A - 2500 A)
Accuracy (long stroke current)	5 % (at 100 A - 2500 A), 10 % (at 25 A - 100 A)
For mounting on	35 mm DIN rails acc. to EN 60715

^{*)} accessory, must be ordered separately.



Impulse Counter



Registration of discharge processes

- Potential-free registration of discharge currents occurring in surge protective devices
- Easy installation by enclosing the earthing conductor of the arrester with a hinged toroidal core
- Counter in a DIN rail mounted enclosure (2 modules)
- Twisted sensor cable, 0.5 m

Counter with LCD display and integrated battery supply (3 V) and battery charge control. Indication of the battery status and the number of lightning events including date and time.

Impulse counter P3: Counter, sensor cable and toroidal core

P 3 Impulse Counter

NEW



Type	IPC P3
Part No.	910 512 <small>NEW</small>
Response threshold for impulse currents (rise time \geq 8 µs)	1 kA
LCD display	electronic counter 0-999
Power supply	3 V lithium battery (CR17335) included in delivery, replaceable, battery life of 3 years
Setting device	button on the device for setting the counter (e.g. after replacing a battery)
Resetting device	button on the device for resetting the counter to 0
Dimensions (sensor)	inner Ø: 14 mm
Accessories included in delivery	3 V lithium battery (CR17335); cable tie (for fixing the sensor)



SPD Test Device

- For routine tests of surge protective devices
- Compact dimensions
- Suitable for mains and battery operation
- Low battery indicator
- Test leads included in delivery



For testing the sparkover voltage of surge arresters. The specimen is connected via the test leads supplied or special test adapters.

The PM 20 SPD test device with integrated detection of the sparkover voltage is used to test Red/Line and Yellow/Line surge arresters with an integrated varistor, Zener diode or gas discharge tube. Both the sparkover performance between the connections of the arresters and the continuity

can be tested. The results can be compared to the limit values specified in the instructions for use. In case of deviations, the arrester or protection module must be replaced.



Indication of the measured sparkover voltage.



The sparkover performance of gas discharge tubes, varistors and Zener diodes can be tested.



Insulated test leads included in delivery.



Can be directly connected to a DEHN-guard protection module.

PM 20

Combined device for testing the sparkover voltage of surge arresters (with gas discharge tubes/varistors/Zener diodes). Storage bag and measuring accessories included.

Type	PM 20
Part No.	910 511
Nominal voltage (U _N)	8-12 V d.c.
Test parameter: Test voltage	max. 1250 V d.c.
Test parameter: Test current (reference voltage)	1 mA d.c., constant
Measured value indication	alphanumeric, eight-digit LCD
Accessories included in delivery	2 test leads (each 1 m long), 2 safety tapping test clips, 1 plug-in power supply unit (230 V a.c.), 1 storage bag





DEHNpanel



Visual indicator for surge protective devices installed in switchgear cabinets.

- Remote visual indicator for surge protective devices (SPDs)
- Easy installation
- For installation in switchgear doors
- Low energy consumption due to current-saving LEDs
- Supplied by two AA batteries
- Easy battery replacement without opening the switchgear door
- Wire breakage detection by connecting the break contact of the remote signalling contact

DEHNpanel remotely indicates the status of surge protective devices with remote signalling contact in a switchgear installation.

High-luminosity LEDs clearly indicate the status of the surge protective device even under difficult lighting conditions. Due to the simple integration, also in an existing switchgear, the operator of the plant has a con-

venient way of checking the installed protective devices without having to open the switchgear cabinet.

The current-saving LEDs ensure a long battery service life of several years. Since the batteries can be changed without opening the switchgear, this can also be done by people without electrical training.

DPAN L

Visual indicator for surge protective devices installed in switchgear cabinets.



Type	DPAN L
Part No.	910 200
Voltage supply	2x 1.5 V lithium batteries, size AA
Operating state / fault indication	green LED (flashing) / red LED (flashing)
Flashing frequency	0.1 s on / 1.3 s off
Degree of protection (front / rear side)	IP 40 / IP 20
Mounting dimensions	92 x 45 mm
Dimensions	96 x 48 x 75 mm



Wiring Accessories DK

- Allows changing of the wiring level
- For lightning current suitable installation of arrester combinations



Uniform wiring level from the top thanks to DK 25 feed-through terminal.

Feed-Through Terminal DK 25

Feed-through terminal for busbar wiring.

Type	DK 25
Part No.	952 699
Nominal voltage (a.c. / d.c.) (U _N)	500 V
Nominal load current (a.c.) (I _N)	100 A
Lightning impulse current (10/350 μs)	100 kA
Cross-sectional area (min.)	1.5 mm ² solid / flexible
Cross-sectional area (max.)	25 mm ² stranded / 16 mm ² flexible



Wiring Accessories STAK

- EMC-optimised series connection according to IEC 60364-5-53



STAK 2X16 for EMC-optimised series connection of lightning current and surge arresters according to IEC 60364-5-53.



STAK 3X16 for EMC-optimised series connection of string lines in a PV generator junction box.

STAK 25 Pin-shaped Terminal

Pin-shaped terminal for EMC-optimised series connection of lightning current and surge arresters according to IEC 60364-5-53.

Type STAK ...	25
Part No.	952 589
Nominal voltage (a.c. / d.c.) (U _N)	600 V
Max. PV voltage (U _{CPV}) when used in combination with DEHNguard M YPV ...	1200 V
Lightning impulse current (10/350 μs)	25 kA
Discharge current (8/20 μs)	50 kA
Cross-sectional area (min.)	1.5 mm ² solid / flexible
Cross-sectional area (max.)	25 mm ² stranded / 16 mm ² flexible
Type of connection	front



STAK 2X16 Pin-shaped Terminal

Pin-shaped terminal for EMC-optimised series connection of lightning current and surge arresters according to IEC 60364-5-53.

Type STAK ...	3X16	2X16
Part No.	900 588	900 589
Nominal voltage (a.c. / d.c.) (U _N)	690 V / 1000 V	—
Load current at V-wiring	80 A	—
Lightning impulse current (10/350 μs)	25 kA	25 kA
Cross-sectional area (min.)	1.5 mm ² solid / flexible	2x 1.5 mm ²
Cross-sectional area (max.)	16 mm ² stranded / 10 mm ² flexible	2x max. 16 mm ²
Type of connection	front	front (double terminal)



Insulating Enclosures

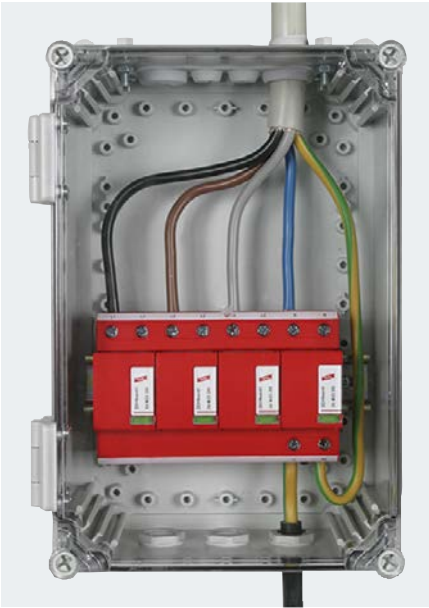

- Lightning-impulse-current-tested insulating enclosure for arresters

Application example: Modular DEHNventil M TNS installed in an IGA 10 V2 IP54 insulating enclosure.

IGA 10 V2 IP54

Lightning-current-tested insulating enclosure with a max. capacity of ten modules; with grommet flange for 11 EPDM cables (Ø5-30 mm) and three mounted M20 grommet openings with lock nut; ideally suited for series connection.



Type IGA ...	10 V2 IP54
Part No.	902 315
Degree of protection	IP 54
Type	lightning-current-tested
Number of cable entries	4x for cables Ø5-7mm; 3x for cables Ø7-10 mm; 2x for cables Ø10-14 mm or Ø15-30 mm each; 3x for cables Ø8-13 mm
Capacity	10 modules, DIN 43880
Dimensions (W x H x D)	200 x 300 x 132 mm
Cover	sealable

IGA 7 IP54

Lightning-current-tested insulating enclosure with a max. capacity of seven modules; with EPDM grommet flange for two cables (Ø1-25 mm) and three mounted M20 grommet openings with lock nut; ideally suited for series connection.



Type IGA ...	7 IP54
Part No.	902 314
Degree of protection	IP 54
Type	lightning-current-tested
Number of cable entries	2x for cables Ø1-25 mm; 3x for cables Ø8-13 mm
Capacity	7 modules, DIN 43880
Dimensions (W x H x D)	175 x 250 x 100 mm
Cover	sealable

IGA 6 IP54

Lightning-current-tested insulating enclosure with a max. capacity of six modules for non-exhausting arresters; with knockouts for entering the cables and plug-in glands; ideally suited for series connection.



Type IGA ...	6 IP54
Part No.	902 485
Degree of protection	IP 54
Type	lightning-current-tested
Number of cable entries	2 plug-in glands for cables Ø8-23 mm (M32 knockout)
Capacity	6 modules, DIN 43880
Dimensions (W x H x D)	165 x 255 x 115 mm
Cover	sealable

IGA 12 IP54

Insulating enclosure with a max. capacity of 12 modules for non-exhausting arresters; with integrated elastic sealing grommet for entering the cables; ideally suited for series connection.

Type IGA ...	12 IP54
Part No.	902 471
Degree of protection	IP 54
Number of cable entries	8x for cables Ø7-12 mm; 8x for cables Ø7-14 mm; 4x for cables Ø12-20 mm; 1x for cables Ø16.5-29 mm (top and bottom)
PE / N quantity x cross-section	3x 25 mm ² , 12x 4 mm ² , Cu
Capacity	12 modules, DIN 43880
Dimensions (W x H x D)	295 x 333 x 129 mm



IGA 12 IP65

Lightning-current-tested insulating enclosure with a max. capacity of 12 modules for non-exhausting arresters; with integrated elastic sealing grommet for entering the cables; ideally suited for series connection.

Type IGA ...	12 IP65
Part No.	902 316
Degree of protection	IP 65
Type	lightning-current-tested
Number of cable entries	8x for cables Ø7-12 mm; 8x for cables Ø7-14 mm; 4x for cables Ø12-20 mm; 1x for cables Ø16.5-29 mm (top and bottom)
PE / N quantity x cross-section	3x 25 mm ² , 12x 4 mm ² , Cu
Capacity	12 modules, DIN 43880
Dimensions (W x H x D)	295 x 333 x 129 mm



IGA 24 IP54

Insulating enclosure with a max. capacity of 2x 12 modules for non-exhausting arresters; with integrated elastic sealing grommet for entering the cables; ideally suited for series connection.

Type IGA ...	24 IP54
Part No.	902 472
Degree of protection	IP 54
Number of cable entries	8x for cables Ø7-12 mm; 8x for cables Ø7-14 mm; 4x for cables Ø12-20 mm; 1x for cables Ø16.5-29 mm (top and bottom)
PE / N quantity x cross-section	6x 25 mm ² , 24x 4 mm ² , Cu
Capacity	24 modules (2x 12 modules), DIN 43880
Dimensions (W x H x D)	295 x 458 x 129 mm



Accessories for Insulating Enclosures

Sealing Device

For sealing between the lower and upper part of IGA 12 and IGA 24 insulating enclosures (doors can be sealed without additional part).

Type	PLOV IGA 12 24
Part No.	902 317
Material	aluminium



Busbars / Modular Wiring System

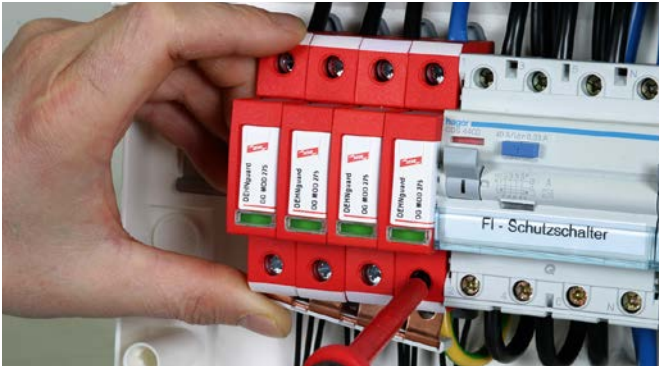

- Allows compact connection of arresters with each other and with other DIN rail mounted devices



MVS single-phase, two-pole

For connecting the earth terminal of e.g. 2 DEHNgard S surge arresters to earth.



Type	MVS 1 2
Part No.	900 617
Type	single-phase
Number of contact studs	2
Max. installation length	2 module(s)
Nominal cross-section	16 mm ²

MVS single-phase, three-pole

For connecting the earth terminal of e.g. 3 DEHNgard S surge arresters to earth.

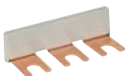

Type	MVS 1 3
Part No.	900 615
Type	single-phase
Number of contact studs	3
Max. installation length	3 module(s)
Nominal cross-section	16 mm ²

MVS single-phase, four-pole

For connecting the earth terminal of e.g. 4 DEHNgard S surge arresters to earth.

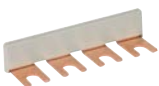

Type	MVS 1 4
Part No.	900 610
Type	single-phase
Number of contact studs	4
Max. installation length	4 module(s)
Nominal cross-section	16 mm ²

MVS single-phase, six-pole

For connecting the earth terminal of e.g. 3 type 1 SPDs with two-module enclosure to earth.



Type	MVS 1 6
Part No.	900 815
Type	single-phase
Number of contact studs	6
Max. installation length	6 module(s)
Nominal cross-section	16 mm ²

MVS single-phase, seven-pole

For connecting the earth terminal of e.g. 3 DEHnbloc Maxi and 1 DEHNgap Maxi in 3+1 configuration to earth.

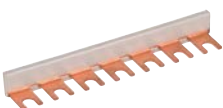

Type	MVS 1 7
Part No.	900 848
Type	single-phase
Number of contact studs	7
Max. installation length	7 module(s)
Nominal cross-section	16 mm ²

MVS single-phase, eight-pole

For connecting the earth terminal of e.g. 4 DEHNbloc Maxi lightning current arresters to earth.

Type	MVS 1 8
Part No.	900 611
Type	single-phase
Number of contact studs	8
Max. installation length	8 module(s)
Nominal cross-section	16 mm ²



MVS single-phase, 57-pole

For connecting the earth terminal of lightning current and surge arresters or combinations thereof to earth.

Type	MVS 1 57
Part No.	900 612
Type	single-phase
Number of contact studs	57
Max. installation length	57 module(s)
Nominal cross-section	16 mm ²

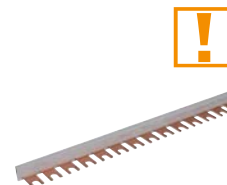

MVS three-phase, six-pole, 6 Modules

For phase-side connection of surge arresters.

Type	MVS 3 6 6
Part No.	900 595
Type	three-phase
Number of contact studs	6
Max. installation length	6 module(s)
Nominal cross-section	16 mm ²

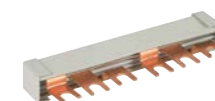

MVS three-phase, six-pole, 8 Modules

For phase-side connection of DIN rail mounted devices to DEHNventil M TNC.

Type	MVS 3 6 8
Part No.	900 813
Type	three-phase
Number of contact studs	6
Max. installation length	8 module(s)
Nominal cross-section	16 mm ²

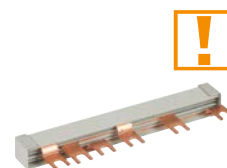

MVS three-phase, six-pole, 9 Modules

For phase-side connection of three-pole surge arresters to fuse holders (for 1.5-module enclosures).

Type	MVS 3 6 9
Part No.	900 839
Type	three-phase
Number of contact studs	6
Max. installation length	9 module(s)
Nominal cross-section	16 mm ²

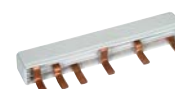

MVS four-phase, eight-pole

For phase-side connection of DIN rail mounted devices to DEHNventil M TNS and TT.

Type	MVS 4 8 11
Part No.	900 814
Type	four-phase
Number of contact studs	8
Max. installation length	11 module(s)
Nominal cross-section	16 mm ²

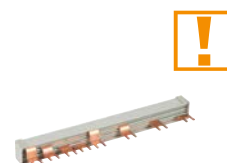

MVS four-phase, 56-pole

For phase-side connection of surge arresters.

Type	MVS 4 56
Part No.	900 614
Type	four-phase
Number of contact studs	56
Max. installation length	56 module(s)
Nominal cross-section	16 mm ²



Earthing Clip for 1.5-module Enclosures, single-phase, two-pole

Earthing clip for connecting e.g. two SPDs with 1.5-module enclosure, with terminal.



Type	EB 1 2 1.5
Part No.	900 460
Type	single-phase
Number of contact studs	2
Dimensions	34 x 60 x 28 mm
Material	copper and tin-plated brass
Terminal	up to 25 mm ²

Earthing Clip for 1.5-module Enclosures, single-phase, three-pole

Earthing clip for connecting e.g. three SPDs with 1.5-module enclosure, with terminal.



Type	EB 1 3 1.5
Part No.	900 418
Type	single-phase
Number of contact studs	3
Dimensions	34 x 85 x 28 mm
Material	copper and tin-plated brass
Terminal	up to 25 mm ²

Earthing Clip for 1.5-module Enclosures, single-phase, four-pole

Earthing clip for connecting e.g. four SPDs with 1.5-module enclosure, with terminal.



Type	EB 1 4 1.5
Part No.	900 429
Type	single-phase
Number of contact studs	4
Dimensions	34 x 112 x 28 mm
Material	copper and tin-plated brass
Terminal	up to 25 mm ²

Earthing Clip for two-module Enclosures, single-phase, two-pole

Earthing clip for connecting e.g. two SPDs with two-module enclosure, with terminal.



Type	EB 1 2 5
Part No.	900 419
Type	single-phase
Number of contact studs	2
Dimensions	34 x 77 x 28 mm
Material	copper and tin-plated brass
Terminal	up to 25 mm ²

Earthing Clip for two-module Enclosures, single-phase, three-pole

Earthing clip for connecting e.g. three SPDs with two-module enclosure, with terminal.



Type	EB DG 1000 1 3
Part No.	900 411
Type	single-phase
Number of contact studs	3
Dimensions	34 x 112 x 28 mm
Material	copper and tin-plated brass
Terminal	up to 25 mm ²

Earthing Clip for two-module Enclosures, single-phase, four-pole

Earthing clip for connecting e.g. four SPDs in a two-module enclosure, with terminal.



Type	EB 1 4 9
Part No.	900 417
Type	single-phase
Number of contact studs	4
Dimensions	34 x 148 x 28 mm
Material	copper and tin-plated brass
Terminal	up to 25 mm ²

Earthing Clip for three-module Enclosures, single-phase, three-pole

Earthing clip for connecting e.g. three SPDs with three-module enclosure, with terminal.

Type	EB 1 3 10
Part No.	900 461
Type	single-phase
Number of contact studs	3
Dimensions	34 x 158 x 28 mm
Material	copper and tin-plated brass
Terminal	up to 25 mm ²



Earthing Clip for three-module Enclosures, single-phase, four-pole

Earthing clip for connecting e.g. four SPDs with three-module enclosure, with terminal.

Type	EB 1 4 13
Part No.	900 462
Type	single-phase
Number of contact studs	4
Dimensions	34 x 212 x 28 mm
Material	copper and tin-plated brass
Terminal	up to 25 mm ²



Outdated Part No.	Type	Current Product Part No.	Type
Combined Arresters – Type 1 + Type 2			
900 342	DLM PV 1000 V2	900 070	DCB YPV 1200
900 345	DLM PV 1000 V2 FM	900 075	DCB YPV SCI 1000 FM
900 060	DCB YPV SCI 600	900 070	DCB YPV 1200
900 065	DCB YPV SCI 600 FM	900 075	DCB YPV SCI 1000 FM
900 061	DCB YPV SCI 1000	900 070	DCB YPV 1200
900 066	DCB YPV SCI 1000 FM	900 075	DCB YPV SCI 1000 FM
900 062	DCB YPV SCI 1500	900 071	DCB YPV 1500
900 067	DCB YPV SCI 1500 FM	900 076	DCB YPV SCI 1500 FM
900 370	DV 2P TT 255	951 110	DV M TT 2P 255
		951 115	DV M TT 2P 255 FM
900 371	DV 2P TN 255	951 200	DV M TN 255
		951 205	DV M TN 255 FM
900 373	DV TNC 255	951 300	DV M TNC 255
		951 305	DV M TNC 255 FM
900 374	DV TNS 255	951 400	DV M TNS 255
		951 405	DV M TNS 255 FM
900 375	DV TT 255	951 310	DV M TT 255
		951 315	DV M TT 255 FM

Outdated Part No.	Type	Current Product Part No.	Type
Coordinated Lightning Current Arresters – Type 1			
900 015	DBM 1 135	961 110	DB M 1 150
		961 115	DB M 1 150 FM
900 016	DBM 1 320	961 130	DB M 1 320
		961 135	DB M 1 320 FM
900 025	DBM 1 255	961 120	DB M 1 255
900 026	DBM 1 255 L	961 125	DB M 1 255 FM
900 044	DBM 440	961 140	DBM 1 440
		961 145	DBM 1 440 FM
900 055	DGPM 255	961 101	DGP M 255
		961 105	DGP M 255 FM

Outdated Part No.	Type	Current Product Part No.	Type
Lightning Current Arresters – Type 1			
900 110	DB 3 255	900 120	DB 3 255 H
900 111	DB 1 255	900 222	DB 1 255 H
900 132	DGP BN 255	961 102	DGPH M 255
900 159	DB 1 440	961 140	DBM 1 440
		961 145	DBM 1 440 FM
900 269	DGP B NH00 N 255	—	—
900 273	DB NH00 255 H	900 255	DBM NH00 255

Outdated Part No.	Type	Current Product Part No.	Type
Surge Arresters – Type 2			
900 133	DGP C T 255	952 030	DGP C S
		952 035	DGP C S FM
900 506	DG TN 230	952 200	DG M TN 275
900 507	DG TN 230 FM	952 205	DG M TN 275 FM
900 508	DG TT 230	952 110	DG M TT 2P 275
900 509	DG TT 230 FM	952 115	DG M TT 2P 275 FM
900 510	DG TNC 230 400	952 300	DG M TNC 275
900 516	DG IT 500	952 302	DG M WE 600
900 517	DG Y PV 1000	952 510	DG M YPV SCI 1000
		952 511	DG M YPV SCI 600
900 520	DG TT 230 400	952 310	DG M TT 275
900 530	DG TNS 230 400	952 400	DG M TNS 275
900 540	DG TNC 230 400 FM	952 305	DG M TNC 275 FM
900 546	DG IT 500 FM	952 307	DG M WE 600 FM
900 547	DG Y PV 1000 FM	952 515	DG M YPV SCI 1000 FM
		952 516	DG M YPV SCI 600 FM
900 550	DG TT 230 400 FM	952 315	DG M TT 275 FM
900 560	DG TNS 230 400 FM	952 405	DG M TNS 275 FM
900 600	DG 275	952 070	DG S 275
900 601	DG 600	952 076	DG S 600
900 602	DG 385	952 074	DG S 385
900 603	DG 150	952 072	DG S 150
900 604	DG 75	952 071	DG S 75
900 605	DG 320	952 073	DG S 320
900 607	DG 440	952 075	DG S 440

Outdated Part No.	Type	Current Product Part No.	Type
900 620	DG 275 FM	952 090	DG S 275 FM
900 621	DG 600 FM	952 096	DG S 600 FM
900 622	DG 385 FM	952 094	DG S 385 FM
900 623	DG 150 FM	952 092	DG S 150 FM
900 624	DG 75 FM	952 091	DG S 75 FM
900 625	DG 320 FM	952 093	DG S 320 FM
900 627	DG 440 FM	952 095	DG S 440 FM
900 641	DG T 385	952 074	DG S 385
900 650	DG T 275	952 070	DG S 275
900 651	DG T 600	952 076	DG S 600
900 652	DG T 320	952 073	DG S 320
900 653	DG T 150	952 072	DG S 150
900 654	DG T 75	952 071	DG S 75
900 655	DG T 440	952 075	DG S 440
900 659	DG T 275 VA	952 082	DG S 275 VA
900 667	DG T 75 VA	952 080	DG S 75 VA
900 680	DG T 275 FM	952 090	DG S 275 FM
900 681	DG T 600 FM	952 096	DG S 600 FM
900 682	DG T 320 FM	952 093	DG S 320 FM
900 683	DG T 150 FM	952 092	DG S 150 FM
900 684	DG T 75 FM	952 091	DG S 75 FM
900 685	DG T 440 FM	952 095	DG S 440 FM
900 689	DG T 275 VA FM	952 087	DG S 275 VA FM
900 691	DG T 385 FM	952 094	DG S 385 FM
900 692	DG T 75 VA FM	952 085	DG S 75 VA FM
950 120	DG T H 275 LI	952 930	DG SE H LI 275 FM
950 121	DG T H 385 LI	952 934	DG SE H LI 385 FM
950 150	DG TT H 230 400 LI	953 930 (3x)	DG SE H LI 275 FM
		952 035 (1x)	DGP C S FM
950 151	DG TT H230 400 LI385	—	—
950 160	DG TNC H230 400 LI	952 930 (3x)	DG SE H LI 275 FM
950 170	DG TNS H230 400 LI	952 930 (4x)	DG SE H LI 275 FM
950 220	DG T 48	952 078	DG S 48
950 225	DG T 48 FM	952 098	DG S 48 FM

Outdated Part No.	Type	Current Product Part No.	Type
Surge Arresters – Type 3			
901 100	DR 230 FML	953 205	DR M 2P 255 FM
		953 200	DR M 2P 255
901 101	DR 120 FML	953 209	DR M 2P 150 FM
		953 204	DR M 2P 150
901 102	DR 60 FML	953 208	DR M 2P 75 FM
		953 203	DR M 2P 75
901 103	DR 48 FML	953 207	DR M 2P 60 FM
		953 202	DR M 2P 60
901 104	DR 24 FML	953 206	DR M 2P 30 FM
		953 201	DR M 2P 30
901 130	DR 230 3N FML	953 405	DR M 4P 255 FM
		953 400	DR M 4P 255
909 820	SF PRO	909 240	DPRO 230 F
909 821	S PRO	909 230	DPRO 230
912 260	SFL PRO	909 250	SFL PRO 6X
924 339	NSM PRO AZ	—	—
924 340	AR1 AZ	—	—
924 342	NSM PRO EW	—	—
924 343	AR1 EW	—	—

Outdated Part No.	Type	Current Product Part No.	Type
General Accessories			
900 309	IGA 10 IP54	902 315	IGA 10 V2 IP54
902 480	IGA 10 IP55	902 315	IGA 10 V2 IP54
900 699	DK 35	952 699	DK 25
910 600	DISO 3	—	—

Outdated Part No.	Type	Current Product Part No.	Type
Isolating Spark Gaps			
923 070	EXFS C1	923 100	EXFS 100
923 071	EXFS C1 KU	923 101	EXFS 100 KU

Surge Protection for INFORMATION TECHNOLOGY SYSTEMS

SPDs for Installations and Devices



Yellow / Line



DEHN protects.



Selection Guide according to Interface / Signal

135



Pluggable SPDs – DIN Rail Mounted

BLITZDUCTORconnect – Modular, BLITZDUCTOR XT/XTU/SP

155



Compact SPDs – DIN Rail Mounted

BLITZDUCTORconnect – Compact, DEHNconnect, DEHNvario

181



SPDs for LSA Technology

DEHNrapid LSA

195



SPDs for Field Devices

DEHNpipe

205



SPDs for Telecommunication and Data Networks

DEHNpatch

211



SPDs for Building Systems

DEHNprotector, DEHNbox, BUStector

215



SPDs for Coaxial Connection

UGKF, DEHNgate

221



SPDs for SUB-D Connection

FS

227



Shield Connection Systems and Enclosures

229



Measuring and Test Devices

235

SPDs for Information Technology Systems



Selection of arresters for information technology systems

The following must be observed when selecting arresters:

- Protective effect
[Yellow/Line SPD class (discharge capacity and voltage protection level)]
- System parameters
(system voltage, nominal current and transmission parameters)
- Installation environment
(design, connection conditions and approvals)

The selection guide according to interface/signal on pages 135 – 154 facilitates the selection of the right arrester.

Relevant product standard for arresters:

IEC / DIN EN 61643-21

Low-voltage surge protective devices – Part 21: Surge protective devices connected to telecommunications and signalling networks – Performance requirements and testing methods.

Discharge capacity

According to IEC/EN 61643-21 arresters must be tested with at least one impulse voltage and impulse current from the table below with the specified quantity of impulses. Further tests may be performed – even with different impulse values or quantities. The max. voltage level measured during the test(s) at the output of the device is specified as voltage protection level U_p . Category C above all represents interference impulses with a steep rate of rise and low energy, while interference impulses of category D are supposed to simulate high energy loads caused by injected partial lightning currents. The relevant category is specified in the technical data of the arresters [see discharge capacity (I_n , I_{imp}) and voltage protection level (U_p)].

Category	Type of test	Impulse voltage	Impulse current	Minimum quantity of impulses	Test for
C1		0.5 kV to 2 kV, 1.2/50 μ s	0.25 kA to 1 kA, 8/20 μ s	300	Surge arrester
C2	fast rate of rise	2 kV to 10 kV, 1.2/50 μ s	1 kA to 5 kA, 8/20 μ s	10	
C3		\geq 1 kV, 1 kV/ μ s	10 A to 100 A, 10/1000 μ s	300	
D1	high energy	\geq 1 kV	0.5 kA to 2.5 kA, 10/350 μ s	2	

*) Lightning current arrester / Combined lightning current and surge arrester

Impulse voltages and currents (preferred values) for determining the voltage-limiting characteristics (excerpt from Table 3 of IEC/EN 61643-21)

Use of arresters

The application guide CLC TS 61643-22 / IEC 61643-22 describes principles for selecting and using arresters. It defines basic requirements on the loads with which arresters are tested for using arresters at the different zone transitions of the lightning protection zone concept according to IEC/EN 62305. The protection components at the different lightning protection zones must therefore cope with with defined pulse categories.

Lightning protection zone	LPZ 0/1	LPZ 1/2	LPZ 2/3
---------------------------	---------	---------	---------

Entrance point into the building	D1		
Sub-distribution board		C2	
Terminal device			C1

Impulse category requirements for SPDs for information technology applications according to the lightning protection zone concept

To make the selection of arresters easier for the user, the SPD class (TYPE classification) for Yellow/Line arresters is based on that of arresters (Red/Line) for power supply systems. However, so-called combined arresters can also be used universally at the different lightning protection zones. Consequently, the different impulse categories (D1, C2, C1) for the arresters are specified according to their possible point of use.

LPZ	EN/IEC 61643-21	EN/IEC 61643-11
0/1	D1 0.5 ... 2.5 kA (10/350 μ s)	Type 1 / I
1/2	C2 1 ... 5 kA (8/20 μ s)	Type 2 / II
2/3	C1 0.25 ... 1 kA (8/20 μ s)	Type 3 / III

Impulse categories and arrester classification for arresters in information technology and power supply systems

Immunity of terminal equipment to be protected

During electromagnetic compatibility (EMC) tests, electrical and electronic equipment (devices) must have a certain immunity to conducted interferences (surges). The requirements on the immunity and the test set-up are described in IEC/EN 61000-4-5.

Since the devices are used in different electromagnetic environments, they must have different immunities. The immunity of a device depends on the test level. To classify the different immunities of terminal equipment, test levels are subdivided into four different levels (1 to 4). Test level 1 places the lowest requirement on the immunity of terminal equipment. The test level is specified in the arrester documentation or can be requested from the manufacturer of the arrester.

Test levels 1 – 4 according to EN 61000-4-5	Corresponds to the charging voltage of the test generator
1	0.5 kV
2	1 kV
3	2 kV
4	4 kV

Protective effect of arresters

Yellow/Line arresters for use in information technology systems are capable of limiting conducted interference to a safe level so that the immunity of the terminal equipment is not exceeded. For example, an arrester with a let-through value below the EMC test values of the terminal device must be selected for a terminal device tested with test level 2: Impulse voltage < 1 kV in combination with an impulse current of some amperes (depending on the coupling network).

Yellow/Line SPD Classes – Symbols

All SPDs of the Yellow/Line family for use in information technology systems are assigned to a Yellow/Line SPD class and marked with a symbol in the technical data sheet and on their rating plates. The symbol for the Yellow/Line SPD class graphically combines three important characteristics of the SPD and can be a single symbol or a combination of individual symbols:

Characteristics	Single symbol	Definition
Discharge capacity of an SPD (according to the categories from IEC/EN 61643-21)	TYPE 1	Impulse D1 (10/350), lightning impulse current 0.5 to 2.5 kA/line • exceeds the discharge capacity of TYPE 2 – TYPE 4
	TYPE 2	Impulse C2 (8/20), increased impulse load 1 to 5 kA/line • exceeds the discharge capacity of TYPE 3 – TYPE 4
	TYPE 3	Impulse C1 (8/20), impulse load 0.25 to 1 kA/line • exceeds the discharge capacity of TYPE 4
	TYPE 4	Load < TYPE 3
Protective effect of an SPD (limitation below the test levels according to EN 61000-4-5)	P1	Required test level of the terminal device: 1 or higher
	P2	Required test level of the terminal device: 2 or higher
	P3	Required test level of the terminal device: 3 or higher
	P4	Required test level of the terminal device: 4
Energy coordination (with another Yellow/Line SPD)	+	SPD with decoupling impedance, suitable for coordination with an SPD marked with ☐
	☐	SPD is suitable for coordination with an SPD with decoupling impedance +

Examples of energy-coordinated SPDs according to the Yellow/Line SPD class:

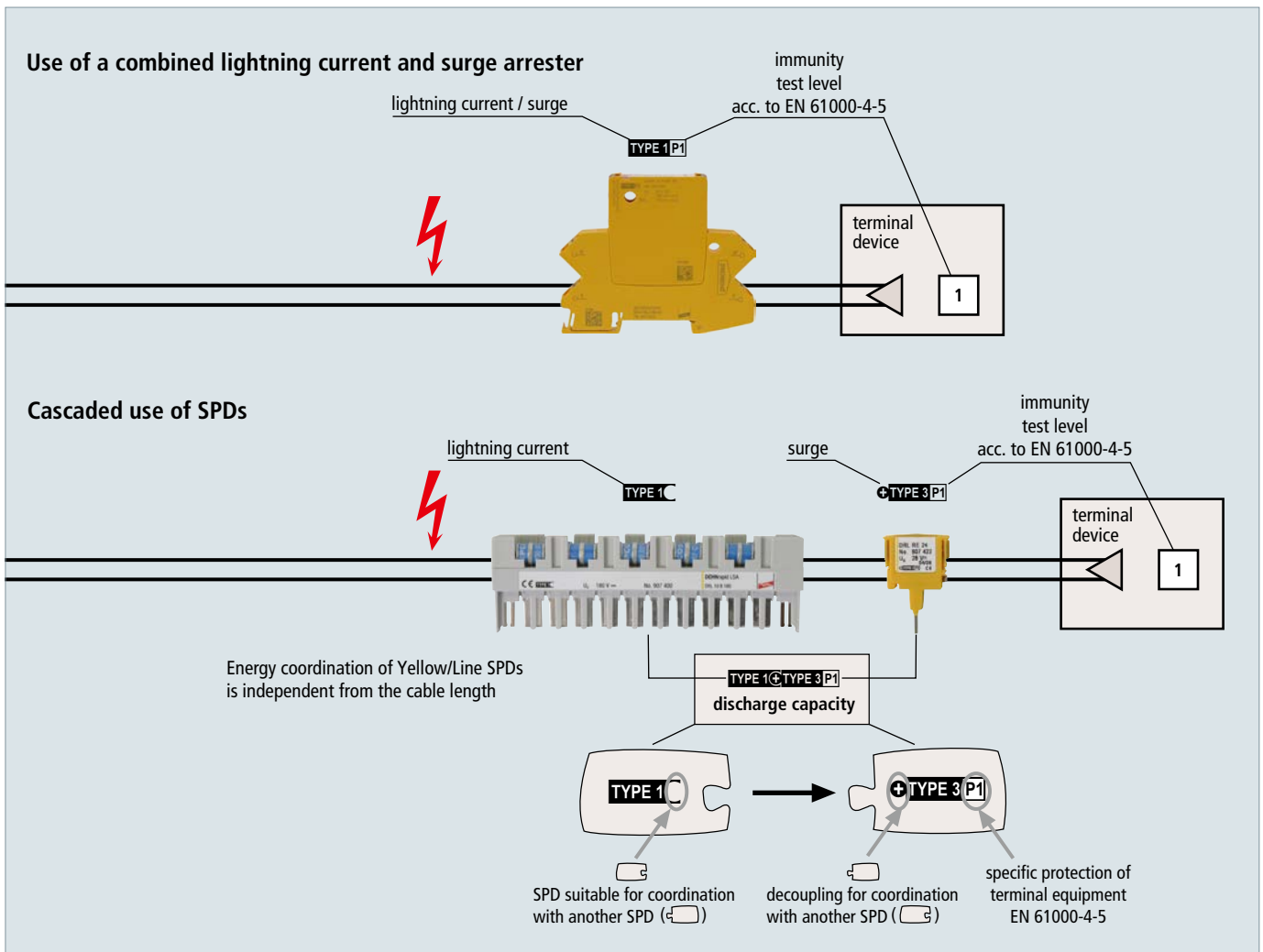

Yellow/Line Selection Guide



Bus systems and measuring and control equipment

Telecommunication systems, telephone systems

Data networks

Antenna systems, broadband systems, transmitting and receiving systems, video systems

Page 135 – 144

Page 145 – 148











































































Page 149 – 150

Page 151 – 153

This selection guide serves as a general source of orientation.

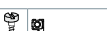
In practice, there may be other interface parameters. Therefore, we recommend to checking whether the electrical parameters are suited for the interface to be protected before using the arrester.

Bus systems and measuring and control equipment











































































































Interface / Signal	Mounting on	Connection system	Protected lines	Monitoring	SPD class Type	SPD	Part No.	Page
0-20 mA, 4-20 mA (also with HART)		Spring terminals	2		1		927 224	157
		Screw terminals	4		1		920 324 ¹⁾	163
		Screw terminals	2		1		920 224 ¹⁾	166
		Spring terminals	2		1		927 924	183
		Wires / Terminals	2		2		929 921	206
		LSA	20		1		907 401 + 907 422 + 907 498	197 199
4-20 mA (also with HART) acc. to NAMUR recommendation NE 21 or according to EN 61000-4-5, open-circuit voltage 1 kV line-PG		Spring terminals	2		1		927 244	157
		Screw terminals	4		1		920 344 ¹⁾	163
		Screw terminals	2		1		920 244 ¹⁾	166
		Spring terminals	2		1		927 944	183
		Wires / Terminals	2		2		929 941	206
		LSA	20		1		907 401 + 907 442 + 907 498	197 199
3/4 conductor measurement		Screw terminals	4		1		920 350 ¹⁾	164
		Screw terminals	4		1		920 354 ¹⁾	164
ADVANT		Spring terminals	2		1		927 271	157
		Screw terminals	4		1		920 370 ¹⁾	164
		Screw terminals	2		1		920 270 ¹⁾	166
		Spring terminals	2		1		927 971	183
		Screw terminals	5		2		918 401	192
AS interface		Spring terminals	2		1		927 245	157
		Screw terminals	4		1		920 345 ¹⁾	163
		Screw terminals	2		1		920 245 ¹⁾	165
		Spring terminals	2		1		927 945	183
BACnet/IP		RJ45	4 x 2		2		929 100	212
		RJ45	4 x 2		2		929 121	212
		RJ45	4 x 2		2		929 126	212
		RJ45	4 x 2		2		929 221	211
		RJ45	4		2		909 321	217

¹⁾ with universal base part BXT BAS (Part No. 920 300) or BSP BAS 4 (Part No. 926 304) please refer to page 161

²⁾ with universal base part BXT BAS EX (Part No. 920 301) please refer to page 173

Bus systems and measuring and control equipment









































































































Selection Guide

Interface / Signal	Mounting on	Connection system	Protected lines	Monitoring	SPD class Type	SPD	Part No.	Page
BACnet MS/TP		Spring terminals	2		1		927 271	157
		Screw terminals	4		1		920 371 ¹⁾	164
		Screw terminals	2		1		920 271 ¹⁾	166
		Spring terminals	2		1		927 971	183
		LSA	20		1		907 401 +907 470 +907 498	197 199
Binary signals		Spring terminals	2		1		927 222/224/225	157
		Screw terminals	4		1		920 320 – 327 ¹⁾	163
		Screw terminals	2		1		920 220 – 225 ¹⁾	166
		Spring terminals	2		1		927 922/924/925	183
		LSA	20		1		907 401 +907 422 +907 498	197 199
Bitbus		Spring terminals	2		1		927 270	157
		Screw terminals	4		1		920 370 ¹⁾	164
		Screw terminals	2		1		920 270 ¹⁾	166
		Spring terminals	2		1		927 970	183
BLN (Building Level Network)		Spring terminals	2		1		927 242	157
		Spring terminals	2		1		927 245	157
		Screw terminals	4		1		920 342 ¹⁾	163
		Screw terminals	2		1		920 242 ¹⁾	165
		Screw terminals	4		1		920 345 ¹⁾	163
		Screw terminals	2		1		920 245 ¹⁾	165
		Spring terminals	2		1		927 942	183
		Spring terminals	2		1		927 945	183
CAN bus (data line only)		Spring terminals	2		1		927 271	158
		Screw terminals	4		1		920 371 ¹⁾	164
		Screw terminals	2		1		920 271 ¹⁾	166
		Spring terminals	2		1		927 971	183
		LSA	20		1		907 401 +907 470 +907 498	197 199
C bus (Honeywell)		Spring terminals	2		1		927 271	158
		Screw terminals	4		1		920 371 ¹⁾	164
		Screw terminals	2		1		920 271 ¹⁾	166
		Spring terminals	2		1		927 971	183
Cathodic protection systems								
	Sensor circuit		Screw terminals	2		1		918 421
Anode circuit		Screw terminals	2		1		918 420	193
Control Net		BNC	1		2		929 010	222
		BNC	1		2		909 710 / 711	222
DALI bus		Spring terminals	2		1		927 244	157
		Screw terminals	2		1		920 244 ¹⁾	165
		Spring terminals	2		1		927 944	183

¹⁾ with universal base part BXT BAS (Part No. 920 300) or BSP BAS 4 (Part No. 926 304) please refer to page 161

²⁾ with universal base part BXT BAS EX (Part No. 920 301) please refer to page 173





































































































Bus systems and measuring and control equipment

Interface / Signal	Mounting on	Connection system	Protected lines	Monitoring	SPD class Type	SPD	Part No.	Page
Data Highway Plus		Spring terminals	2		1		927 242	157
		Screw terminals	4		1		920 342 ¹⁾	163
		Screw terminals	2		1		920 242 ¹⁾	165
		Spring terminals	2		1		927 942	183
d.c. power supply up to 60 V d.c.		Screw terminals	2		3		918 422	192
		Screw terminals	2		1		918 408	192
		Screw terminals	2		1		918 409	192
Delta Net Peer Bus		Spring terminals	2		1		927 270	157
		Screw terminals	4		1		920 370 ¹⁾	164
		Screw terminals	2		1		920 270 ¹⁾	166
		Spring terminals	2		1		927 970	183
Device Net (data line only)		Spring terminals	2		1		927 271	158
		Screw terminals	4		1		920 371 ¹⁾	164
		Screw terminals	2		1		920 271 ¹⁾	166
		Spring terminals	2		1		927 971	183
DMX bus (lighting technology)		Spring terminals	2		1		927 271	158
		Screw terminals	4		1		920 371 ¹⁾	164
		Screw terminals	2		1		920 271 ¹⁾	166
		Spring terminals	2		1		927 971	183
Dupline		Screw terminals	4		1		920 243 ¹⁾	167
E bus (Honeywell)		Spring terminals	4		1		927 245	157
		Screw terminals	4		1		920 345 ¹⁾	163
		Screw terminals	2		1		920 245 ¹⁾	165
		Spring terminals	2		1		927 945	183
EIB		Spring terminals	2		1		927 210	157
		Screw terminals	4		1		920 310 ¹⁾	162
		Screw terminals	2		1		920 211 ¹⁾	166
		Spring terminals	2		1		927 910	183
		Wires	2		2		925 001	218
		LSA	20		1		907 401	197
Electroacoustic system		Screw terminals	4		1		920 347 ¹⁾	163
		Spring terminals	2		1		928 430	190
		LSA	20		1		907 401 + 907 445 + 907 498	197 199
ET 200		Spring terminals	2		1		927 270	157
		Screw terminals	4		1		920 370 ¹⁾	164
		Screw terminals	2		1		920 270 ¹⁾	166
		Spring terminals	2		1		927 970	183

¹⁾ with universal base part BXT BAS (Part No. 920 300) or BSP BAS 4 (Part No. 926 304) please refer to page 161
²⁾ with universal base part BXT BAS EX (Part No. 920 301) please refer to page 173

Bus systems and measuring and control equipment

















































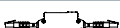

















































Selection Guide

Interface / Signal	Mounting on	Connection system	Protected lines	Monitoring	SPD class Type	SPD	Part No.	Page
Ex(d) circuits 4-20 mA, NAMUR, HART, PROFIBUS-PA, F 		Wires	2		2		929 962 / 964	207
		Wires	4		2		929 950 / 951	208
Ex (i) circuits 		Spring terminals	2		1		927 284	158
		Screw terminals	4		2		920 381 ²⁾	174
		Screw terminals	4		2		920 538 ²⁾	174
		Screw terminals	2		2		920 280 ²⁾	174
		Screw terminals	2		2		920 383 ²⁾	175
		Spring terminals	2		1		927 984	184
		Wires / Terminals	2		2		929 960 / 965	207
		Wires	2		2		929 961 / 963	207
		Wires	4		2		929 950 / 951	208
		Screw terminals	4		2		989 408	175
Fieldbus Foundation		Spring terminals	2		1		927 244	157
		Screw terminals	4		1		920 344 ¹⁾	163
		Screw terminals	2		1		920 244 ¹⁾	165
		Spring terminals	2		1		927 944	183
		Wires / Terminals	2		2		929 941	206
		LSA	20		1		907 401 + 907 442 + 907 498	197 199
Fieldbus Foundation Ex (i) 		Spring terminals	2		1		927 284	158
		Screw terminals	4		2		920 381 ²⁾	174
		Screw terminals	4		2		920 538 ²⁾	174
		Screw terminals	2		2		920 280 ²⁾	174
		Screw terminals	2		2		920 383 ²⁾	175
		Spring terminals	2		1		927 984	184
		Wires / Terminals	2		2		929 960 / 965	207
		Wires	2		2		929 961 / 963	207
		Wires	2		2		929 971	207
		Wires	4		2		929 950 / 951	208
	Screw terminals	4		2		989 408	175	
FIPIO/FIPWAY		Spring terminals	2		1		927 244	157
		Screw terminals	4		1		920 344 ¹⁾	163
		Screw terminals	2		1		920 244 ¹⁾	165
		Spring terminals	2		1		927 944	183
FIP I/O		Spring terminals	2		1		927 270	157
		Screw terminals	4		1		920 370 ¹⁾	164
		Screw terminals	2		1		920 270 ¹⁾	166
		Spring terminals	2		1		927 970	183

¹⁾ with universal base part BXT BAS (Part No. 920 300) or BSP BAS 4 (Part No. 926 304) please refer to page 161









































































































²⁾ with universal base part BXT BAS EX (Part No. 920 301) please refer to page 173

Bus systems and measuring and control equipment

Interface / Signal	Mounting on	Connection system	Protected lines	Monitoring	SPD class Type	SPD	Part No.	Page
FSK		Spring terminals	2		1		927 271	158
		Screw terminals	4		1		920 371 ¹⁾	164
		Screw terminals	2		1		920 271 ¹⁾	166
		Spring terminals	2		1		927 971	183
Genius I/O bus		Spring terminals	2		1		927 242	157
		Screw terminals	4		1		920 342 ¹⁾	163
		Screw terminals	2		1		920 242 ¹⁾	165
		Spring terminals	2		1		927 942	183
IEC bus (RS485)		Spring terminals	2		1		927 271	158
		Screw terminals	4		1		920 371 ¹⁾	164
		Screw terminals	2		1		920 271 ¹⁾	166
		Spring terminals	2		1		927 971	183
Industrial Ethernet		LSA	20		1		907 401 + 907 470 + 907 498	197 199
		RJ45	4 x 2		2		929 100	212
		RJ45	4 x 2		2		929 121	212
		RJ45	4 x 2		2		929 126	212
		RJ45	4 x 2		2		929 221	211
		RJ45	4		2		909 321	217
INTERBUS INLINE (I/O)		Spring terminals	2		1		927 225	157
		Spring terminals	2		1		927 245	157
		Screw terminals	4		1		920 345 ¹⁾	163
		Screw terminals	4		1		920 325 ¹⁾	163
		Spring terminals	2		1		927 925	183
		Spring terminals	2		1		927 945	183
Interbus INLINE remote bus		Spring terminals	2		1		927 225	157
		Spring terminals	2		1		927 245	157
		Screw terminals	4		1		920 371 ¹⁾	164
		Screw terminals	2		1		920 271 ¹⁾	166
		Spring terminals	2		1		927 925	183
		Spring terminals	2		1		927 945	183
		Screw terminals	5		2		918 401	192
INTERBUS loop		Spring terminals	2		3		917 988	186
K bus		Spring terminals	2		1		927 244	157
		Screw terminals	4		1		920 344 ¹⁾	163
		Screw terminals	2		1		920 244 ¹⁾	165
		Spring terminals	2		1		927 944	183

¹⁾ with universal base part BXT BAS (Part No. 920 300) or BSP BAS 4 (Part No. 926 304) please refer to page 161
²⁾ with universal base part BXT BAS EX (Part No. 920 301) please refer to page 173







































































































Bus systems and measuring and control equipment

Interface / Signal	Mounting on	Connection system	Protected lines	Monitoring	SPD class Type	SPD	Part No.	Page	
KBR energy bus		Spring terminals	2		1		927 270	157	
		Screw terminals	4		1		920 370 ¹⁾	164	
		Screw terminals	2		1		920 270 ¹⁾	166	
		Spring terminals	2		1		927 970	183	
KNX bus		Spring terminals	2		1		927 210	157	
		Screw terminals	4		1		920 310 ¹⁾	162	
		Screw terminals	2		1		920 211 ¹⁾	166	
		Spring terminals	2		1		927 910	183	
		Wires	2		2		925 001	218	
		LSA	20		1		907 401	197	
LON		Spring terminals	2		1		927 245	157	
		Screw terminals	4		1		920 340 ¹⁾	163	
		Screw terminals	2		1		920 240 ¹⁾	165	
		Spring terminals	2		1		927 945	183	
	– TP/FTT10 and TP/LPT10	(up to 1 A) 	Screw terminals	4		1		920 345 ¹⁾	163
		(up to 1 A) 	Screw terminals	2		1		920 245 ¹⁾	165
	– TP/FTT 10	(up to 0.4 A) 	LSA	20		1		907 401 +907 443 +907 498	197 199
			Spring terminals	2		1		927 271	158
			Screw terminals	4		1		920 371 ¹⁾	164
			Screw terminals	2		1		920 271 ¹⁾	166
		Spring terminals	2		1		927 971	183	
LUXMATE bus		Spring terminals	2		1		927 244	157	
		Screw terminals	4		1		920 344 ¹⁾	163	
		Screw terminals	2		1		920 244 ¹⁾	165	
		Spring terminals	2		1		927 944	183	
M bus		Spring terminals	2		1		927 245	157	
		Screw terminals	4		1		920 345 ¹⁾	163	
		Screw terminals	2		1		920 245 ¹⁾	165	
		Spring terminals	2		1		927 945	183	
		LSA	20		1		907 401 +907 443 +907 498	197 199	
Melsec Net 2		BNC	1		2		929 010	222	
		BNC	1		2		909 710 / 711	222	
MODBUS		Spring terminals	2		1		927 271	158	
		Screw terminals	4		1		920 371 ¹⁾	164	
		Screw terminals	2		1		920 271 ¹⁾	166	
		Spring terminals	2		1		927 971	183	
		LSA	20		1		907 401 +907 470 +907 498	197 199	

¹⁾ with universal base part BXT BAS (Part No. 920 300) or BSP BAS 4 (Part No. 926 304) please refer to page 161

²⁾ with universal base part BXT BAS EX (Part No. 920 301) please refer to page 173





































































































Bus systems and measuring and control equipment

Interface / Signal	Mounting on	Connection system	Protected lines	Monitoring	SPD class Type	SPD	Part No.	Page
MPI bus		Spring terminals	2		1		927 271	158
		Screw terminals	4		1		920 371 ¹⁾	164
		Screw terminals	2		1		920 271 ¹⁾	166
		Spring terminals	2		1		927 971	183
N1 LAN		Spring terminals	2		1		927 271	158
		Screw terminals	4		1		920 371 ¹⁾	164
		Screw terminals	2		1		920 271 ¹⁾	166
		Spring terminals	2		1		927 971	183
		Spring terminals	2		1		927 270	157
		Screw terminals	4		1		920 370 ¹⁾	164
		Spring terminals	2		1		927 970	183
		BNC	1		2		909 710 / 711	222
N2 bus (Johnson Controls, LON, FTT 10)		Spring terminals	2		1		927 271	158
		Screw terminals	4		1		920 371 ¹⁾	164
		Screw terminals	2		1		920 271 ¹⁾	166
		Spring terminals	2		1		927 971	183
Optocoupler interface		Screw terminals	4		1		920 364 ¹⁾	164
Procontic CS31 (RS232)		Spring terminals	2		1		927 242	157
		Screw terminals	4		1		920 322 ¹⁾	163
		Spring terminals	2		1		927 942	183
Procontic T200 (RS422)		Spring terminals	2		1		927 271	158
		Screw terminals	4		1		920 371 ¹⁾	164
		Spring terminals	2		1		927 971	183
		Screw terminals	5		2		918 401	192
PROFIBUS-DP/FMS		Spring terminals	2		1		927 271	158
		Screw terminals	4		1		920 371 ¹⁾	164
		Screw terminals	2		1		920 271 ¹⁾	166
		Spring terminals	2		1		927 971	183
		9-pin SUB-D	4		4		924 017	227
		LSA	20		1		907 401 + 907 470 + 907 498	197 199
PROFIBUS-PA		Spring terminals	2		1		927 244	157
		Screw terminals	4		1		920 344 ¹⁾	163
		Screw terminals	2		1		920 244 ¹⁾	165
		Spring terminals	2		1		927 944	183
		Wires / Terminals	2		2		929 941	206
		LSA	20		1		907 401 + 907 442 + 907 498	197 199

¹⁾ with universal base part BXT BAS (Part No. 920 300) or BSP BAS 4 (Part No. 926 304) please refer to page 161
²⁾ with universal base part BXT BAS EX (Part No. 920 301) please refer to page 173

Bus systems and measuring and control equipment









































































































Selection Guide

Interface / Signal	Mounting on	Connection system	Protected lines	Monitoring	SPD class Type	SPD	Part No.	Page
PROFIBUS-PA Ex (i) 		Screw terminals	4		2		920 381 ²⁾	174
		Screw terminals	2		2		920 538 ²⁾	174
		Screw terminals	2		2		920 280 ²⁾	174
		Screw terminals	2		2		920 383 ²⁾	175
		Wires / Terminals	2		2		929 960 / 965	207
		Wires	2		2		929 961 / 963	207
		Wires	4		2		929 950 / 951	208
		Screw terminals	4		2		989 408	175
PROFIBUS SIMATIC NET		Spring terminals	2		1		927 271	158
		Screw terminals	4		1		920 371 ¹⁾	164
		Screw terminals	2		1		920 271 ¹⁾	166
		Spring terminals	2		1		927 971	183
PSM-EG-RS422		Spring terminals	2		1		927 271	158
		Screw terminals	4		1		920 371 ¹⁾	164
		Screw terminals	5		2		918 401	192
		Spring terminals	2		1		927 971	183
PSM-EG-RS485		Spring terminals	2		1		927 271	158
		Screw terminals	4		1		920 371 ¹⁾	164
		Screw terminals	2		1		920 271 ¹⁾	166
		Spring terminals	2		1		927 971	183
		Screw terminals	5		2		918 401	192
Rackbus (RS485)		Spring terminals	2		1		927 271	158
		Screw terminals	4		1		920 371 ¹⁾	164
		Screw terminals	2		1		920 271 ¹⁾	166
		Spring terminals	2		1		927 971	183
		Screw terminals	5		2		918 401	192
R bus		Spring terminals	2		1		927 242	157
		Screw terminals	4		1		920 340 ¹⁾	163
		Screw terminals	2		1		920 240 ¹⁾	165
		Spring terminals	2		1		927 942	183
RS 485		Spring terminals	2		1		927 271	158
		Screw terminals	4		1		920 371 ¹⁾	164
		Screw terminals	2		1		920 271 ¹⁾	166
		Spring terminals	2		1		927 971	183
		Screw terminals	5		2		918 401	192
		LSA	20		1		907 401 +907 470 +907 498	197 199

¹⁾ with universal base part BXT BAS (Part No. 920 300) or BSP BAS 4 (Part No. 926 304) please refer to page 161

²⁾ with universal base part BXT BAS EX (Part No. 920 301) please refer to page 173















































































































Bus systems and measuring and control equipment

Interface / Signal	Mounting on	Connection system	Protected lines	Monitoring	SPD class Type	SPD	Part No.	Page
RS 485 Ex (i) 		Screw terminals	4		2		920 538 ²⁾	174
		Wires	2		2		929 971	207
RS422, V11		Spring terminals	2		1		927 271	158
		Screw terminals	4		1		920 371 ¹⁾	164
		Screw terminals	2		1		920 271 ¹⁾	166
		Spring terminals	2		1		927 971	183
		Screw terminals	5		2		918 401	192
		LSA	20		1		907 401 + 907 470 + 907 498	197 199
S bus		Spring terminals	2		1		927 270	157
		Screw terminals	4		1		920 370 ¹⁾	164
		Screw terminals	2		1		920 270 ¹⁾	166
		Spring terminals	2		1		927 970	183
SafetyBUS p		Spring terminals	2		1		927 271	158
		Screw terminals	4		1		920 371 ¹⁾	164
		Screw terminals	2		1		920 271 ¹⁾	166
		Spring terminals	2		1		927 971	183
SDLC		Spring terminals	2		1		927 271	158
		Screw terminals	4		1		920 370 ¹⁾	164
		Screw terminals	2		1		920 270 ¹⁾	166
		Spring terminals	2		1		927 971	183
SDLS		LSA	20		1		907 401 + 907 423 + 907 498	197 199
Securilan-LON-Bus (LONWORKS technology Standard Bus based on Echelon)		Spring terminals	2		1		927 242	157
		Screw terminals	4		1		920 340 ¹⁾	163
		Screw terminals	2		1		920 240 ¹⁾	165
		Spring terminals	2		1		927 942	183
SIGMASYS (Siemens fire alarm system)		Spring terminals	2		1		927 245	157
		Screw terminals	4		1		920 345 ¹⁾	163
		Screw terminals	2		1		920 245 ¹⁾	165
		Screw terminals	4		1		920 325 ¹⁾	163
		Screw terminals	2		1		920 225 ¹⁾	166
		Spring terminals	2		1		927 945	183
		LSA	20		1		907 401 + 907 423 + 907 498	197 199
SINEC L1		Spring terminals	2		1		927 270	157
		Screw terminals	4		1		920 370 ¹⁾	164
		Screw terminals	2		1		920 270 ¹⁾	166
		Spring terminals	2		1		927 970	183

¹⁾ with universal base part BXT BAS (Part No. 920 300) or BSP BAS 4 (Part No. 926 304) please refer to page 161
²⁾ with universal base part BXT BAS EX (Part No. 920 301) please refer to page 173

Bus systems and measuring and control equipment





























































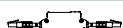



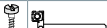























Selection Guide

Interface / Signal	Mounting on	Connection system	Protected lines	Monitoring	SPD class Type	SPD	Part No.	Page
SINEC L2		Spring terminals	2		1		927 270	157
		Screw terminals	4		1		920 370 ¹⁾	164
		Screw terminals	2		1		920 270 ¹⁾	166
		Spring terminals	2		1		927 970	183
		9-pin SUB-D	4		4		924 017	227
SS97 SIN/X (RS 232)		Spring terminals	2		1		927 242	157
		Screw terminals	4		1		920 322 ¹⁾	163
		Screw terminals	2		1		920 222 ¹⁾	166
		Spring terminals	2		1		927 942	183
SUCONET		Spring terminals	2		1		927 271	158
		Screw terminals	4		1		920 371 ¹⁾	164
		Screw terminals	2		1		920 271 ¹⁾	166
		Spring terminals	2		1		927 971	183
Temperature measurement PT 100, PT 1000, Ni 1000, NTC, PTC		Spring terminals	2		1		927 242	157
		Screw terminals	4		1		920 354 ¹⁾	164
		Screw terminals	2		1		920 222 ¹⁾	166
		Spring terminals	2		1		927 942	183
Temperature measurement Ex (i) PT 100, PT 1000 Ni 1000, NTC, PTC 		Spring terminals	2		1		927 284	158
		Screw terminals	4		2		920 384 ²⁾	174
		Spring terminals	2		1		927 984	184
TTL		Spring terminals	2		1		927 242	157
		Screw terminals	4		1		920 322 ¹⁾	163
		Screw terminals	2		1		920 222 ¹⁾	166
		Spring terminals	2		1		927 942	183
TTY		Screw terminals	4		1		920 364 ¹⁾	164
		Screw terminals	4		1		920 362 ¹⁾	164
TTY 4 – 20 mA		Spring terminals	2		1		927 224	157
		Screw terminals	4		1		920 324 ¹⁾	163
		Screw terminals	2		1		920 224 ¹⁾	166
		Spring terminals	2		1		927 924	183
		Wires / Terminals	2		2		929 921	206
a/b wires		Spring terminals	2		1		927 210	157
		Screw terminals	4		1		920 347 ¹⁾	163
		Spring terminals	2		1		927 910	183
		LSA	20		1		907 401 +907 430 +907 498	197 199
		RJ45, screw terminals	2		2		918 411	192
		TAE, RJ12	2		2		909 310	217
		Spring terminals	2		1		922 220	220

¹⁾ with universal base part BXT BAS (Part No. 920 300) or BSP BAS 4 (Part No. 926 304) please refer to page 161



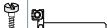













































































²⁾ with universal base part BXT BAS EX (Part No. 920 301) please refer to page 173

Telecommunication systems, telephone systems

Interface / Signal	Mounting on	Connection system	Protected lines	Monitoring	SPD class Type	SPD	Part No.	Page
ADSL		Spring terminals	2		1		927 210	157
		Screw terminals	4		1		920 347 ¹⁾	163
		Screw terminals	2		1		920 247 ¹⁾	165
		Spring terminals	2		1		927 910	183
		LSA	20		1		907 401 + 907 430 + 907 498	197 199
		TAE, RJ12	2		2		909 310	217
		RJ45, screw terminals	2		2		918 411	192
		Spring terminals	2		1		922 220	220
ADSL 2+		Spring terminals	2		1		927 210	157
		Screw terminals	4		1		920 347 ¹⁾	163
		Spring terminals	2		1		927 910	183
		LSA	20		1		907 401 + 907 430 + 907 498	197 199
		Spring terminals	2		1		922 220	220
Datex-P		Screw terminals	4		1		920 375 ¹⁾	164
E1		RJ45	4 x 2		2		929 100	212
		RJ45	4 x 2		2		929 121	212
		RJ45	4 x 2		2		929 126	212
		RJ45	4 x 2		2		929 221	211
		LSA	20		1		907 401 + 907 470 + 907 498	197 199
G.703 / G.704		Insulation displacement terminals	2		2		907 214	200
		RJ45	4 x 2		2		929 100	212
		RJ45	4 x 2		2		929 121	212
		RJ45	4 x 2		2		929 126	212
		RJ45	4 x 2		2		929 221	211
		LSA	20		1		907 401 + 907 470 + 907 498	197 199
		Screw terminals	4		1		920 375 ¹⁾	164
G.fast		LSA	20		1		907 401	197
		Spring terminals	2		1		927 210	157
		Screw terminals	4		1		920 310 ¹⁾	162
		Spring terminals	2		1		927 910	183
		Spring terminals	2		1		922 220	220
HDSL		Screw terminals	4		1		920 375 ¹⁾	164
		LSA	20		1		907 401 + 907 470 + 907 498	197 199
		RJ45	4 x 2		2		929 100	212
		RJ45	4 x 2		2		929 121	212
		RJ45	4 x 2		2		929 126	212
		RJ45	4 x 2		2		929 221	211

¹⁾ with universal base part BXT BAS (Part No. 920 300) or BSP BAS 4 (Part No. 926 304) please refer to page 161
²⁾ with universal base part BXT BAS EX (Part No. 920 301) please refer to page 173















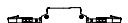



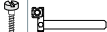

























































Telecommunication systems, telephone systems

Interface / Signal	Mounting on	Connection system	Protected lines	Monitoring	SPD class Type	SPD	Part No.	Page
IP telephone		RJ45	4 x 2		2		929 100	212
		RJ45	4 x 2		2		929 121	212
		RJ45	4 x 2		2		929 126	212
		RJ45	4 x 2		2		929 221	211
		RJ45	4		2		909 321	217
		Spring terminals	2		1		922 220	220
ISDN S ₀		Screw terminals	4		1		920 375 ¹⁾	164
		LSA	20		1		907 401 +907 470 +907 498	197 199
		RJ45	4		2		909 320	217
		RJ45	4 x 2		2		929 100	212
		RJ45	4 x 2		2		929 121	212
		RJ45	4 x 2		2		929 126	212
		RJ45	4 x 2		2		929 221	211
ISDN S _{2m} / U _{2m}		Screw terminals	4		1		920 375 ¹⁾	164
		LSA	20		1		907 401 +907 470 +907 498	197 199
		RJ45	4 x 2		2		929 100	212
		RJ45	4 x 2		2		929 121	212
		RJ45	4 x 2		2		929 126	212
		RJ45	4 x 2		2		929 221	211
ISDN U _{K0} / U _{P0}		Screw terminals	4		1		920 347 ¹⁾	163
		Screw terminals	2		1		920 247 ¹⁾	165
		LSA	20		1		907 401 +907 430 +907 498	197 199
		TAE, RJ12	2		2		909 310	217
		RJ45, screw terminals	2		2		918 411	192
		Spring terminals	2		1		922 220	220
Modem M1		Spring terminals	2		1		927 222	157
		Screw terminals	4		1		920 322 ¹⁾	163
		Screw terminals	2		1		920 222 ¹⁾	166
		Spring terminals	2		1		927 922	183
SDSL		RJ45	4 x 2		2		929 100	212
		RJ45	4 x 2		2		929 121	212
		RJ45	4 x 2		2		929 126	212
		RJ45	4 x 2		2		929 221	211
		LSA	20		1		907 401 +907 470 +907 498	197 199
		Screw terminals	4		1		920 375 ¹⁾	164

¹⁾ with universal base part BXT BAS (Part No. 920 300) or BSP BAS 4 (Part No. 926 304) please refer to page 161

²⁾ with universal base part BXT BAS EX (Part No. 920 301) please refer to page 173



















































Telecommunication systems, telephone systems

Interface / Signal	Mounting on	Connection system	Protected lines	Monitoring	SPD class Type	SPD	Part No.	Page
SHDSL		Screw terminals	4		1		920 375 ¹⁾	164
		RJ45	4 x 2		2		929 100	212
		RJ45	4 x 2		2		929 121	212
		RJ45	4 x 2		2		929 126	212
		RJ45	4 x 2		2		929 221	211
		LSA	20		1		907 401 + 907 470 + 907 498	197 199
		Spring terminals	2		1		927 210	157
		Screw terminals	4		1		920 310 ¹⁾	162
		Screw terminals	2		1		920 211 ¹⁾	166
		Spring terminals	2		1		927 910	183
SVVDSL		LSA	20		1		907 401	197
		Spring terminals	2		1		927 210	157
		Screw terminals	4		1		920 310 ¹⁾	162
		Spring terminals	2		1		927 910	183
		Spring terminals	2		1		922 220	220
Telephones System telephones e.g. Siemens, HICOM, Alcatel		Screw terminals	2		1		920 247 ¹⁾	165
		LSA	20		1		907 401 + 907 422 + 907 498	197 199
		LSA	20		1		907 401 + 907 445 + 907 498	197 199
		TAE, RJ12	2		2		909 310	217
		RJ45, screw terminals	2		2		918 411	192
		Spring terminals	2		1		922 220	220
T-DSL		Screw terminals	4		1		920 347 ¹⁾	163
		Screw terminals	2		1		920 247 ¹⁾	165
		LSA	20		1		907 401 + 907 430 + 907 498	197 199
		TAE, RJ12	2		2		909 310	217
		RJ45, screw terminals	2		2		918 411	192
		Spring terminals	2		1		922 220	220
Telecommunication systems		LSA	20		1		907 401 + 907 430 + 907 498	197 199
		Screw terminals	4		1		920 347 ¹⁾	163
		RJ45, screw terminals	2		2		918 411	192
		TAE, RJ12	2		2		909 310	217

¹⁾ with universal base part BXT BAS (Part No. 920 300) or BSP BAS 4 (Part No. 926 304) please refer to page 161

²⁾ with universal base part BXT BAS EX (Part No. 920 301) please refer to page 173

























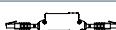













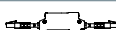











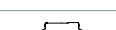









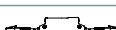





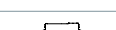

Telecommunication systems, telephone systems

Interface / Signal	Mounting on	Connection system	Protected lines	Monitoring	SPD class Type	SPD	Part No.	Page
Universal lightning equipotential bonding		Spring terminals	2		1		927 210	157
		Screw terminals	4		1		920 310 ¹⁾	162
		Screw terminals	2		1		920 211 ¹⁾	166
		Spring terminals	2		1		927 910	183
		LSA	20		1		907 400	197
		LSA	20		1		907 401	197
		Insulation displacement terminals	20		2		907 214	200
		Insulation displacement terminals	20		2		907 216	200
VDSL		LSA	20		1		907 401	197
		Spring terminals	2		1		927 210	157
		Screw terminals	4		1		920 310 ¹⁾	162
		Screw terminals	2		1		920 211 ¹⁾	166
		Spring terminals	2		1		927 910	183
		Spring terminals	2		1		922 220	220
VDSL2 VVDSL		LSA	20		1		907 401	197
		Spring terminals	2		1		927 210	157
		Screw terminals	4		1		920 310 ¹⁾	162
		Spring terminals	2		1		927 910	183
		Spring terminals	2		1		922 220	220

¹⁾ with universal base part BXT BAS (Part No. 920 300) or BSP BAS 4 (Part No. 926 304) please refer to page 161

²⁾ with universal base part BXT BAS EX (Part No. 920 301) please refer to page 173























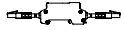















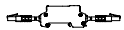

Data networks

Interface / Signal	Mounting on	Connection system	Protected lines	Monitoring	SPD class Type	SPD	Part No.	Page
Arcnet		BNC	1		2		929 010	222
		BNC	1		2		909 710 / 711	222
ATM		RJ45	4 x 2		2		929 100	212
		RJ45	4 x 2		2		929 121	212
		RJ45	4 x 2		2		929 126	212
		RJ45	4 x 2		2		929 221	211
		RJ45	4		2		909 321	217
Ethernet 10/100/1000 10 Base T		RJ45	4 x 2		2		929 100	212
		RJ45	4 x 2		2		929 121	212
		RJ45	4 x 2		2		929 126	212
		RJ45	4 x 2		2		929 221	211
		RJ45	4		2		909 321	217
		RJ45	4		2		909 320	217
		LSA	20		1		907 401 + 907 470 + 907 498	197 199
FDDI, CDDI		RJ45	4 x 2		2		929 100	212
		RJ45	4 x 2		2		929 121	212
		RJ45	4 x 2		2		929 126	210
		RJ45	4 x 2		2		929 221	211
		RJ45	4		2		909 321	217
Industrial Ethernet		LSA	20		1		907 401 + 907 470 + 907 498	197 199
		RJ45	4 x 2		2		929 100	212
		RJ45	4 x 2		2		929 121	212
		RJ45	4 x 2		2		929 126	212
		RJ45	4 x 2		2		929 221	211
		RJ45	4		2		909 321	217
Power over Ethernet PoE		RJ45	4 x 2		2		929 100	212
		RJ45	4 x 2		2		929 121	212
		RJ45	4 x 2		2		929 126	212
		RJ45	4 x 2		2		929 221	211
Token Ring		LSA	20		1		907 401 + 907 470 + 907 498	197 199
		RJ45	4 x 2		2		929 100	212
		RJ45	4 x 2		2		929 121	212
		RJ45	4 x 2		2		929 126	212
		RJ45	4 x 2		2		929 221	211
		RJ45	4		2		909 321	217

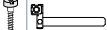
1) with universal base part BXT BAS (Part No. 920 300) or BSP BAS 4 (Part No. 926 304) please refer to page 161
 2) with universal base part BXT BAS EX (Part No. 920 301) please refer to page 173













































































Data networks

Selection Guide

Interface / Signal	Mounting on	Connection system	Protected lines	Monitoring	SPD class Type	SPD	Part No.	Page
V 24 (RS232 C)		Spring terminals	2		1		927 222	157
		Screw terminals	4		1		920 322 ¹⁾	163
		Spring terminals	2		1		927 922	183
		LSA	20		1		907 401 +907 421 +907 498	197 199
VG-AnyLAN		RJ45	4 x 2		2		929 100	212
		RJ45	4 x 2		2		929 121	212
		RJ45	4 x 2		2		929 126	212
		RJ45	4 x 2		2		929 221	211
		RJ45	4		2		909 321	217
Voice over IP		Spring terminals	2		1		927 210	157
		Screw terminals	4		1		920 310 ¹⁾	162
		Spring terminals	2		1		927 910	183
		RJ45	4 x 2		2		929 100	212
		RJ45	4 x 2		2		929 121	212
		RJ45	4 x 2		2		929 126	212
		RJ45	4 x 2		2		929 221	211
		RJ45	4		2		909 321	217
		Spring terminals	2		1		922 220	220

¹⁾ with universal base part BXT BAS (Part No. 920 300) or BSP BAS 4 (Part No. 926 304) please refer to page 161
²⁾ with universal base part BXT BAS EX (Part No. 920 301) please refer to page 173



































































Antenna systems, broadband systems, transmitting and receiving systems, video systems

Interface / Signal	Mounting on	Connection system	Protected lines	Monitoring	Frequency range	SPD class Type	SPD	Part No.	Page
AMPS, NADAC (824 – 894 MHz)		SMA	1		DC – 5.8 GHz	2		929 039	224
		BNC	1		DC – 4 GHz	2		929 042	224
		BNC	1		DC – 1 GHz	1		929 043	224
		N connector	1		DC – 5.8 GHz	2		929 044	224
		N connector	1		DC – 2.5 GHz	1		929 045	224
		7/16 connector	1		DC, 690 MHz – 2.7 GHz	1		929 146	224
		7/16 connector	1		690 MHz – 2.7 GHz	1		929 148	224
BWA (Broadband Wireless Access)		SMA	1		DC – 5.8 GHz	2		929 039	224
		BNC	1		DC – 4 GHz	2		929 042	224
		N connector	1		DC – 5.8 GHz	2		929 044	224
CATV (cable TV)		F connector	1		DC, 5 – 2400 MHz	1		909 705	223
		IEC/F connector	1		DC – 2400 MHz	2		909 300	216
DCF 77		SMA	1		DC – 5.8 GHz	2		929 039	224
		BNC	1		DC – 4 GHz	2		929 042	22
		BNC	1		DC – 1 GHz	1		929 043	224
		Spring terminals	2			1		927 242	157
		Screw terminals	2		DC – 2.8 MHz	1		920 242 ¹⁾	165
		Spring terminals	2			1		927 942	183
DCS 1800 B162 (1710 – 1880 MHz)		SMA	1		DC – 5.8 GHz	2		929 039	224
		BNC	1		DC – 4 GHz	2		929 042	224
		N connector	1		DC – 5.8 GHz	2		929 044	224
		N connector	1		DC – 2.5 GHz	1		929 045	224
		7/16 connector	1		DC, 690 MHz – 2.7 GHz	1		929 146	224
		7/16 connector	1		690 MHz – 2.7 GHz	1		929 148	224
GPS (1565 – 1585 MHz)		SMA	1		DC – 5.8 GHz	2		929 039	224
		BNC	1		DC – 4 GHz	2		929 042	224
		N connector	1		DC – 5.8 GHz	2		929 044	224
		N connector	1		DC – 2.5 GHz	1		929 045	224
		7/16 connector	1		DC, 690 MHz – 2.7 GHz	1		929 146	224
		7/16 connector	1		690 MHz – 2.7 GHz	1		929 148	224
GSM 900, GSMR (876 – 960 MHz)		SMA	1		DC – 5.8 GHz	2		929 039	224
		BNC	1		DC – 4 GHz	2		929 042	224
		BNC	1		DC – 1 GHz	1		929 043	224
		N connector	1		DC – 5.8 GHz	2		929 044	224
		N connector	1		DC – 2.5 GHz	1		929 045	224
		7/16 connector	1		DC, 690 MHz – 2.7 GHz	1		929 146	224
		7/16 connector	1		690 MHz – 2.7 GHz	1		929 148	224

¹⁾ with universal base part BXT BAS (Part No. 920 300) or BSP BAS 4 (Part No. 926 304) please refer to page 161

²⁾ with universal base part BXT BAS EX (Part No. 920 301) please refer to page 173



































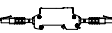









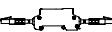



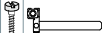







Antenna systems, broadband systems, transmitting and receiving systems, video systems

Interface / Signal	Mounting on	Connection system	Protected lines	Monitoring	Frequency range	SPD class Type	SPD	Part No.	Page
LTE (698 – 2690 MHz)		7/16 connector	1		DC, 690 MHz – 2.7 GHz	1		929 146	224
		7/16 connector	1		690 MHz – 2.7 GHz	1		929 148	224
PCS 1900 (1850 – 1990 MHz)		SMA	1		DC – 5.8 GHz	2		929 039	224
		BNC	1		DC – 4 GHz	2		929 042	224
		N connector	1		DC – 5.8 GHz	2		929 044	224
		N connector	1		DC – 2.5 GHz	1		929 045	224
		7/16 connector	1		DC, 690 MHz – 2.7 GHz	1		929 146	224
		7/16 connector	1		690 MHz – 2.7 GHz	1		929 148	224
Radio systems		SMA	1		DC – 5.8 GHz	2		929 039	224
		BNC	1		DC – 4 GHz	2		929 042	224
		BNC	1		DC – 1 GHz	1		929 043	224
		N connector	1		DC – 5.8 GHz	2		929 044	224
		N connector	1		DC – 2.5 GHz	1		929 045	224
		7/16 connector	1		DC, 690 MHz – 2.7 GHz	1		929 146	224
		7/16 connector	1		380 – 512 MHz	1		929 047	224
		7/16 connector	1		690 MHz – 2.7 GHz	1		929 148	224
SAT		F connector	1		DC, 5 – 2400 MHz	1		909 705	223
		F connector	1		DC, 5 – 3000 MHz	3		909 703	223
		F connector	1		DC – 2400 MHz	1		909 704	223
		F connector	1		47 – 2400 MHz	1		909 706	223
Sky DSL		F connector	1		DC, 5 – 2400 MHz	1		909 705	223
		F connector	1		47 – 2400 MHz	1		909 706	223
TETRA, NMT 450 (380 – 512 MHz)		SMA	1		DC – 5.8 GHz	2		929 039	224
		BNC	1		DC – 4 GHz	2		929 042	224
		BNC	1		DC – 1 GHz	1		929 043	224
		N connector	1		DC – 5.8 GHz	2		929 044	224
		N connector	1		DC – 2.5 GHz	1		929 045	224
		7/16 connector	1		380 – 512 MHz	1		929 047	224
TV		F connector	1		DC, 5 – 3000 MHz	3		909 703	223
		F connector	1		DC – 2400 MHz	1		909 704	223
		F connector	1		DC, 5 – 2400 MHz	1		909 705	223
		F connector	1		47 – 2400 MHz	1		909 706	223
		IEC / F connector	1		DC – 2400 MHz	2		909 300	216

¹⁾ with universal base part BXT BAS (Part No. 920 300) or BSP BAS 4 (Part No. 926 304) please refer to page 161

²⁾ with universal base part BXT BAS EX (Part No. 920 301) please refer to page 173

Antenna systems, broadband systems, transmitting and receiving systems, video systems

Interface / Signal	Mounting on	Connection system	Protected lines	Monitoring	Frequency range	SPD class Type	SPD	Part No.	Page
UMTS		SMA	1		DC – 5.8 GHz	2		929 039	222
		BNC	1		DC – 4 GHz	2		929 042	222
		N connector	1		DC – 5.8 GHz	2		929 044	222
		N connector	1		DC – 2.5 GHz	1		929 045	222
		7/16 connector	1		DC, 690 MHz – 2.7 GHz	1		929 146	222
		7/16 connector	1		690 MHz – 2.7 GHz	1		929 148	222
Video (two-wire)		Spring terminals	2		DC – 100 MHz	1		927 271	158
		Screw terminals	4		DC – 100 MHz	1		920 371 ¹⁾	164
		Screw terminals	2		DC – 100 MHz	1		920 271 ¹⁾	166
		Spring terminals	2		DC – 100 MHz	1		927 971	183
		RJ45	4 x 2		DC – 250 MHz	2		929 100	212
		RJ45	4 x 2		DC – 250 MHz	2		929 121	212
		RJ45	4 x 2		DC – 100 MHz	2		929 126	212
		Screw terminals	2		DC – 100 MHz	1		920 270 ¹⁾	166
		LSA	20		DC – 90 MHz	1		907 401 + 907 470 + 907 498	197 198 199
Video digital (IP camera)		RJ45	4 x 2		DC – 250 MHz	2		929 100	212
		RJ45	4 x 2		DC – 250 MHz	2		929 121	212
		RJ45	4 x 2		DC – 100 MHz	2		929 126	212
		RJ45	4 x 2		DC – 250 MHz	2		929 221	211
Video analogue (coax)		BNC	1		DC – 300 MHz	2		929 010	222
		BNC	1		0 – 300 MHz	2		909 710 / 711	222
		BNC / Spring terminal	3 / 2 / 1		50 Hz / DC-250 MHz / 300 MHz	2		 928 440	190
WLAN (2.4 GHz band)		SMA	1		DC – 5.8 GHz	2		929 039	224
		BNC	1		DC – 4 GHz	2		929 042	224
		N connector	1		DC – 5.8 GHz	2		929 044	224
WLAN (5 GHz band)		SMA	1		DC – 5.8 GHz	2		929 039	224
		N connector	1		DC – 5.8 GHz	2		929 044	224

¹⁾ with universal base part BXT BAS (Part No. 920 300) or BSP BAS 4 (Part No. 926 304) please refer to page 161
²⁾ with universal base part BXT BAS EX (Part No. 920 301) please refer to page 173



DEHN protects.



Pluggable SPDs – DIN Rail Mounted

Basic circuit diagram / Symbol	Type	Product	Part No.	Page
BLITZDUCTORconnect – Modular				
	BCO ML2 ... – Combined lightning current and surge arrester with a modular design – With push-in connection technology and signal disconnection – With vibration-proof secR module locking mechanism – Integrated LifeCheck and visual status indication		927 2XX	157
	BCO ML2 BD EX 24 – Surge arrester with a modular design for hazardous areas – With push-in connection technology and signal disconnection – With vibration-proof secR module locking mechanism – Integrated LifeCheck and visual status indication		927 284	158
Base Parts BXT BAS / BSP BAS 4				
	BXT BAS – Universal base part for protection modules of the BLITZDUCTOR XT/XTU and BLITZDUCTOR SP series – No signal disconnection if the protection module is removed – Connection of up to four lines		920 300	161
	BSP BAS 4 – Universal base part for protection modules of the BLITZDUCTOR XT/XTU and BLITZDUCTOR SP series – Signal disconnection if the protection module is removed – Connection of up to four lines		926 304	161
BLITZDUCTOR XT				
	BXT ML ... – Combined lightning current and surge arrester modules – With integrated LifeCheck – Two-pole and four-pole versions		920 XXX	162
	BXT M2 BD HC5A 24 – Combined lightning current and surge arrester module for protecting 1 pair of unearthed signal circuits – Optimal for protecting DC signal circuits up to a nominal current of 5 A – For controlling motor-driven actuators with high starting and operating currents		920 296	167
BLITZDUCTOR XTU				
	BXTU ML ... – Universal lightning current and surge arrester modules – With integrated LifeCheck – With integrated actiVsense technology – Two-pole and four-pole versions		920 349 920 249	169 169
BLITZDUCTOR XT Ex (i)				
	BXT BAS EX – Universal base part for protection modules of the BLITZDUCTOR XT Ex (i) series – No signal disconnection if the protection module is removed – Connection of up to four lines		920 301	173
	BXT ML ... – Surge arrester modules for hazardous areas – With integrated LifeCheck – Two-pole and four-pole versions		920 XXX	174



BLITZDUCTORconnect – Modular

Pluggable SPDs –
DIN Rail Mounted

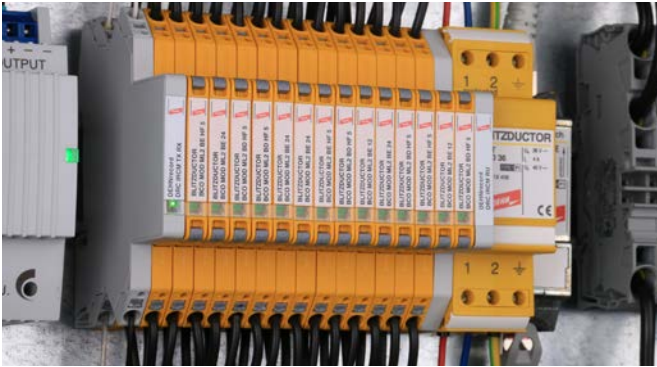

BLITZDUCTORconnect for protecting measuring and control systems

NEW

The combined lightning current and surge arresters of the BLITZDUCTORconnect series are designed for universal use and system protection in industrial environments, at information technology signal interfaces, and in the field of automation or measuring and control technology:

Thanks to their high lightning current discharge capacity and low voltage protection levels, they optimally meet the requirements for reliably protecting terminal equipment.

The arresters are available in different types and protect two single lines sharing a common reference potential (unbalanced interfaces) or one un-earthed pair (balanced interface). An arrester with a high cut-off frequency is available for balanced bus interfaces with high data rates (e.g.: Profibus, RS485), an Ex approved version (dust and gas) for intrinsically safe signal circuits.

The modular design consisting of a base part and protection module allows easy handling and maintenance of the arresters. All protective components are integrated in the module in a space-saving 6 mm wide housing. This facilitates simple and quick replacement in the event of maintenance, thus restoring the protective function of the system without the need for rewiring. The module locking mechanism is vibration and shock-tested and allows safe operation even in demanding environments.

The cables are connected using the vibration-proof push-in connection technology. For connection, stripped solid and flexible conductors with wire end ferrules can be clamped and contacted quickly, easily and without tools. When rewiring, the conductor is freed from the clamping point by pressing the release button and reclamped into the appropriate terminal. Holes in the housing at each conductor terminal allow measurements in the signal circuit using test probes.

- **Universal lightning current and surge arrester**
 - For protecting measuring and control circuits, bus and telecommunication systems
 - High total discharge capacity of 3 kA (10/350 μs), 10 kA (8/20 μs)
 - Max. impulse current carrying capability (8/20 μs) I_{max} up to 20 kA
 - Low voltage protection level, also capable of protecting terminal equipment
- **Arrester consisting of a module and base part**
 - Fast and simple cable connection thanks to push-in connection technology
 - All protection components integrated in the module
 - secR release buttons on both sides for safe module replacement
 - High system availability thanks to fail-safe performance
- **Function-optimised design with a width of 6 mm**
 - LifeCheck and visual status indication integrated in the module
 - Simple remote signalling of the status with the help of an optional remote signalling unit
 - Tool-free signal disconnection for maintenance purposes
 - Vibration and shock-tested for safe operation

The arresters of the BLITZDUCTORconnect series are equipped with a mechanical status indication which clearly shows the status of the arrester (green or red indicator flag). In the event of overload, the red flag indicates which arrester in the group needs replacing. System protection is quickly restored without the need for tools simply by replacing the module. It is no longer necessary to use additional test devices or to remove modules for testing purposes.

Optionally, arrester groups can be monitored using a built-in remote signalling unit. The status is reported to a higher-level control system via a floating break contact. The combination of transmitter and receiver unit in a single device minimises the wiring effort when installing the remote signalling unit. At the same time, there is no need for additional parameterisation of the modules.

A defined fail-safe function (fail-open) disconnects the overloaded components (decoupling impedance, fine protection) from the signal circuit. However, the signal circuit itself remains active and is not interrupted. The system circuit remains available and operation is maintained until the arrester is replaced. In this way, plants and systems can be operated safely and are highly available at all times.

The arresters also feature a disconnection function which makes it possible to interrupt the signal circuit during maintenance (e.g. for measurements). The signal circuit is interrupted by turning the protection module by 180° and inserting it into the base part. Consequently, measurements can be carried out quickly and easily – without the need to use tools or install disconnect terminals.

Arresters with approval for Ex applications and other accessories, e.g. PARTITION EX1 for disconnecting intrinsically safe and non-intrinsically safe signal circuits, round off the product portfolio.



Quickly tested – at a glance
Integrated indication for easy and fast maintenance



Securely locked – precisely removed
secR release buttons on both sides for safe handling



Connect = Protect
Simple status message with monitoring unit for arrester groups



Maximum system availability
Approvals for use in intrinsically safe measuring circuits

BCO ML2 B 180

Space-saving, modular lightning current arrester with a width of 6 mm and push-in connection technology with status indication for protecting two single lines for lightning equipotential bonding as well as indirect earthing of shielded cables. With signal disconnection for maintenance purposes.

Type BCO ...	ML2 B 180
Part No.	927 210 ^{NEW}
SPD class	TYPE 1
Nominal voltage (U _N)	180 V
Max. continuous operating voltage (d.c.) (U _C)	180 V
D1 Lightning impulse current (10/350 μs) per line (I _{imp})	1.5 kA
C2 Total nominal discharge current (8/20 μs) (I _n)	10 kA
Series resistance per line	0 ohm(s)
Approvals	UL, SIL

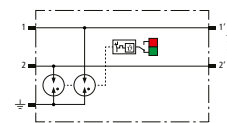

BCO ML2 BE

Space-saving, modular combined arrester with a width of 6 mm and push-in connection technology with status indication for protecting two single lines sharing a common reference potential as well as unbalanced interfaces. With signal disconnection for maintenance purposes.

Type BCO ...	ML2 BE 12	ML2 BE 24	ML2 BE 48
Part No.	927 222 ^{NEW}	927 224 ^{NEW}	927 225 ^{NEW}
SPD class	TYPE 1P1	TYPE 1P1	TYPE 1P1
Nominal voltage (U _N)	12 V	24 V	48 V
Max. continuous operating voltage (d.c.) (U _C)	15 V	33 V	54 V
Nominal current at 70 °C (I _t)	0.75 A	0.75 A	0.75 A
D1 Lightning impulse current (10/350 μs) per line (I _{imp})	1.5 kA	1.5 kA	1.5 kA
C2 Total nominal discharge current (8/20 μs) (I _n)	10 kA	10 kA	10 kA
Series resistance per line	1 ohm(s)	1 ohm(s)	1 ohm(s)
Cut-off frequency line-line (f _C)	1.4 MHz	3.4 MHz	5 MHz
Approvals	UL, SIL	UL, SIL	UL, SIL

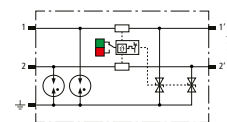

BCO ML2 BD

Space-saving, modular combined arrester with a width of 6 mm and push-in connection technology with status indication for protecting one pair of unearthed balanced interfaces. With signal disconnection for maintenance purposes.

Type BCO ...	ML2 BD 12	ML2 BD 24	ML2 BD 48
Part No.	927 242 ^{NEW}	927 244 ^{NEW}	927 245 ^{NEW}
SPD class	TYPE 1P2	TYPE 1P2	TYPE 1P2
Nominal voltage (U _N)	12 V	24 V	48 V
Max. continuous operating voltage (d.c.) (U _C)	15 V	36 V	56 V
Nominal current at 70 °C (I _t)	0.75 A	0.75 A	0.75 A
D1 Lightning impulse current (10/350 μs) per line (I _{imp})	1.5 kA	1.5 kA	1.5 kA
C2 Total nominal discharge current (8/20 μs) (I _n)	10 kA	10 kA	10 kA
Series resistance per line	1 ohm(s)	1 ohm(s)	1 ohm(s)
Cut-off frequency line-line (f _C)	2.6 MHz	5.8 MHz	3.6 MHz
Approvals	UL, SIL	UL, SIL	UL, SIL

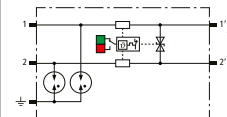

BCO ML2 BE HF

Space-saving, modular combined arrester with a width of 6 mm and push-in connection technology with status indication for protecting two single lines of high-frequency transmissions sharing a common reference potential as well as unbalanced interfaces. With signal disconnection for maintenance purposes.

Type BCO ...	ML2 BE HF 5
Part No.	927 270 ^{NEW}
SPD class	TYPE 1P1
Nominal voltage (U _N)	5 V
Max. continuous operating voltage (d.c.) (U _C)	8.5 V
Nominal current at 70 °C (I _t)	0.75 A
D1 Lightning impulse current (10/350 μs) per line (I _{imp})	1.5 kA
C2 Total nominal discharge current (8/20 μs) (I _n)	10 kA
Series resistance per line	1 ohm(s)
Approvals	UL, SIL

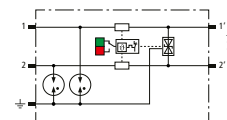

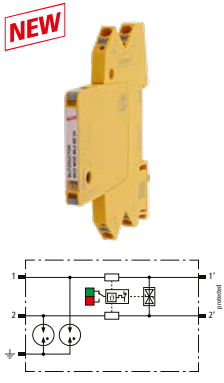

BCO ML2 BD HF

Space-saving, modular combined arrester with a width of 6 mm and push-in connection technology with status indication for protecting one pair of unearthed high-frequency bus systems as well as balanced interfaces. With signal disconnection for maintenance purposes.

Type BCO ...	ML2 BD HF 5
Part No.	927 271 <small>NEW</small>
SPD class	TYPE 1P2
Nominal voltage (U _N)	5 V
Max. continuous operating voltage (d.c.) (U _C)	8.5 V
Nominal current at 70 °C (I _N)	0.75 A
D1 Lightning impulse current (10/350 μs) per line (I _{imp})	1.5 kA
C2 Total nominal discharge current (8/20 μs) (I _n)	10 kA
Series resistance per line	1 ohm(s)
Cut-off frequency line-line (f _G)	100 MHz
Approvals	UL, SIL

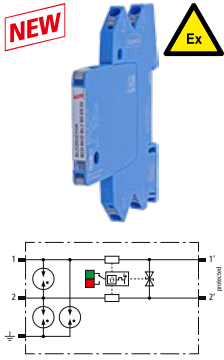

BCO ML2 BD EX 24

Space-saving, modular combined arrester with a width of 6 mm and push-in connection technology with status indication for protecting one pair of intrinsically safe measuring circuits and bus systems, meets FISCO requirements. Insulation strength > 500 V line-ground. With signal disconnection for maintenance purposes.

Type BCO ...	ML2 BD EX 24
Part No.	927 284 <small>NEW</small>
SPD class	TYPE 1P2
Nominal voltage (U _N)	24 V
Max. continuous operating voltage (d.c.) (U _C)	36 V
D1 Lightning impulse current (10/350 μs) per line (I _{imp})	1.5 kA
C2 Total nominal discharge current (8/20 μs) (I _n)	10 kA
Series resistance per line	1 ohm(s)
Cut-off frequency line-line (f _G)	3.5 MHz
Approvals	SIL, ATEX, IECEx

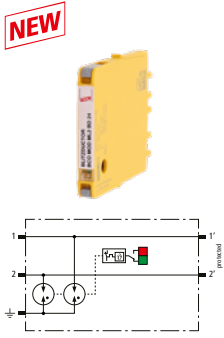

BCO MOD ML2 B

Protection module with a width of 6 mm for BLITZDUCTORconnect lightning current arrester with status indication for protecting two single lines for lightning equipotential bonding as well as indirect earthing of shielded cables.

Type BCO ...	MOD ML2 B 180
Part No.	927 010 <small>NEW</small>
SPD class	TYPE 1
Nominal voltage (U _N)	180 V
Max. continuous operating voltage (d.c.) (U _C)	180 V
D1 Lightning impulse current (10/350 μs) per line (I _{imp})	1.5 kA
C2 Total nominal discharge current (8/20 μs) (I _n)	10 kA
Series resistance per line	0 ohm(s)
Approvals	UL, SIL

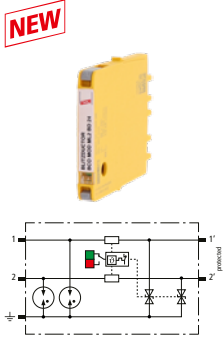

BCO MOD ML2 BE

Protection module with a width of 6 mm for BLITZDUCTORconnect combined arrester with status indication for protecting two single lines sharing a common reference potential as well as unbalanced interfaces.

Type BCO ...	MOD ML2 BE 12	MOD ML2 BE 24	MOD ML2 BE 48
Part No.	927 022 <small>NEW</small>	927 024 <small>NEW</small>	927 025 <small>NEW</small>
SPD class	TYPE 1P1	TYPE 1P1	TYPE 1P1
Nominal voltage (U _N)	12 V	24 V	48 V
Max. continuous operating voltage (d.c.) (U _C)	15 V	33 V	54 V
Nominal current at 70 °C (I _N)	0.75 A	0.75 A	0.75 A
D1 Lightning impulse current (10/350 μs) per line (I _{imp})	1.5 kA	1.5 kA	1.5 kA
C2 Total nominal discharge current (8/20 μs) (I _n)	10 kA	10 kA	10 kA
Series resistance per line	1 ohm(s)	1 ohm(s)	1 ohm(s)
Cut-off frequency line-line (f _G)	1.4 MHz	3.4 MHz	5 MHz
Approvals	UL, SIL	UL, SIL	UL, SIL

BCO MOD ML2 BD

Protection module with a width of 6 mm for BLITZDUCTORconnect combined arrester with status indication for protecting one pair of unearthened balanced interfaces.

Type BCO ...	MOD ML2 BD 12	MOD ML2 BD 24	MOD ML2 BD 48
Part No.	927 042 ^{NEW}	927 044 ^{NEW}	927 045 ^{NEW}
SPD class	TYPE 1P2	TYPE 1P2	TYPE 1P2
Nominal voltage (U _N)	12 V	24 V	48 V
Max. continuous operating voltage (d.c.) (U _C)	15 V	36 V	56 V
Nominal current at 70 °C (I _N)	0.75 A	0.75 A	0.75 A
D1 Lightning impulse current (10/350 µs) per line (I _{imp})	1.5 kA	1.5 kA	1.5 kA
C2 Total nominal discharge current (8/20 µs) (I _n)	10 kA	10 kA	10 kA
Series resistance per line	1 ohm(s)	1 ohm(s)	1 ohm(s)
Cut-off frequency line-line (f _C)	2.6 MHz	5.8 MHz	3.6 MHz
Approvals	UL, SIL	UL, SIL	UL, SIL

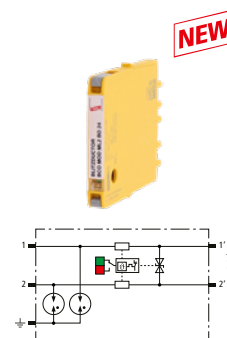

BCO MOD ML2 BE HF

Protection module with a width of 6 mm for BLITZDUCTORconnect combined arrester with status indication for protecting two single lines of high-frequency transmissions sharing a common reference potential as well as unbalanced interfaces.

Type BCO ...	MOD ML2 BE HF 5
Part No.	927 070 ^{NEW}
SPD class	TYPE 1P1
Nominal voltage (U _N)	5 V
Max. continuous operating voltage (d.c.) (U _C)	8.5 V
Nominal current at 70 °C (I _N)	0.75 A
D1 Lightning impulse current (10/350 µs) per line (I _{imp})	1.5 kA
C2 Total nominal discharge current (8/20 µs) (I _n)	10 kA
Series resistance per line	1 ohm(s)
Approvals	UL, SIL

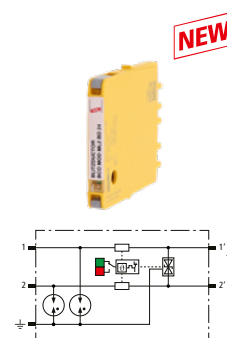

BCO MOD ML2 BD HF

Protection module with a width of 6 mm for BLITZDUCTORconnect combined arrester with status indication for protecting one pair of unearthened high-frequency bus systems as well as balanced interfaces.

Type BCO ...	MOD ML2 BD HF 5
Part No.	927 071 ^{NEW}
SPD class	TYPE 1P2
Nominal voltage (U _N)	5 V
Max. continuous operating voltage (d.c.) (U _C)	8.5 V
Nominal current at 70 °C (I _N)	0.75 A
D1 Lightning impulse current (10/350 µs) per line (I _{imp})	1.5 kA
C2 Total nominal discharge current (8/20 µs) (I _n)	10 kA
Series resistance per line	1 ohm(s)
Cut-off frequency line-line (f _C)	100 MHz
Approvals	UL, SIL

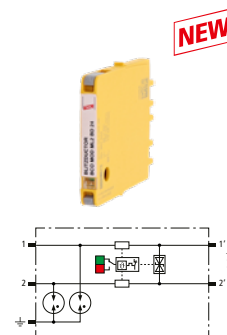

BCO MOD ML2 BD EX 24

Protection module with a width of 6 mm for BLITZDUCTORconnect combined arresters with status indication for protecting one pair of intrinsically safe measuring circuits and bus systems, meets FISCO requirements. Insulation strength > 500 V line-ground.

Type BCO ...	MOD ML2 BD EX 24
Part No.	927 084 ^{NEW}
SPD class	TYPE 1P2
Nominal voltage (U _N)	24 V
Max. continuous operating voltage (d.c.) (U _C)	36 V
D1 Lightning impulse current (10/350 µs) per line (I _{imp})	1.5 kA
C2 Total nominal discharge current (8/20 µs) (I _n)	10 kA
Series resistance per line	1 ohm(s)
Cut-off frequency line-line (f _C)	3.5 MHz
Approvals	SIL, ATEX, IECEx

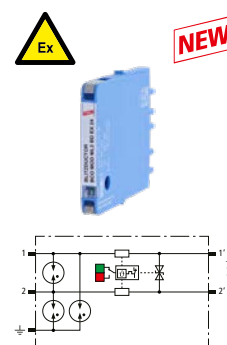

DIN Rail mounted Power Supply Unit

High-performance DIN rail mounted power supply unit with single-phase wide-range input can be connected to different supply systems. The operating state indicator on the front panel indicates whether the output voltage is present. Supplies of stationary condition monitoring devices from the DEHNrecord portfolio (DRC SCM XT / DRC MCM XT / DRC IRCM).



Type	PSU DC24 30W
Part No.	910 499
Input voltage range	AC 85-264 V; DC 120-373 V
Frequency	44-66 Hz; 0 Hz
Input current (I _e)	0.7 A at AC 110 V / 0.5 A at AC 230 V
Output nominal voltage (U _a)	DC 24 V (SELV)
Output current (I _a)	1.3 A at DC 24 V, max. 0.9 A at any installation position
Recommended backup fuse	circuit breaker 10 A, 16 A, characteristic B, C
Standards / regulations	EN 60950, EN 61204-3, UL 60950, UL 508, GL

Pluggable SPDs –
DIN Rail Mounted

NEW



PARTITION EXI

Special installation conditions must be considered when installing BLITZDUCTORconnect surge protective devices in intrinsically safe circuits. In accordance with EN 60079-11;2007 a minimum distance (thread measure) of ≥ 50 mm must be maintained between intrinsically and non-intrinsically safe circuits (connecting parts, e.g. terminals)! When using the Ex i partition of type PARTITION EXI, this distance is also maintained if the surge protective devices are arranged directly next to one other. Ideally suited for use in conjunction with DRC IRCM for condition monitoring of BCO modules (1 set = 2 pieces).

Type	PARTITION EXI
Part No.	910 797 ^{NEW}
Colour	blue
For mounting on	35 mm DIN rails acc. to EN 60715

NEW



DRC IRCM

DEHNrecord condition monitoring unit, DIN rail mounted set with integrated visual transmitter/receiver as well as visual reverse unit for monitoring the condition of BLITZDUCTORconnect arresters with LifeCheck. Visual status indication via LED group display combined with remote signalling (break contact).

Type	DRC IRCM
Part No.	910 710 ^{NEW}
Voltage (U _{IN})	6-35 V DC
Operating current (I _{IN})	≤ 10 mA
Operating temperature range (T _U)	-30 °C ... +70 °C
Approvals	UL, ATEX, IECEx



BLITZDUCTOR – Base Parts

- **BXT BAS – Without signal disconnection / BSP BAS 4 – With signal disconnection**
 - Universal base parts for protection modules of the BLITZDUCTOR XT/XTU/SP series
 - Two base parts with or without signal disconnection if the protection module is removed
 - Connection of up to four lines

BXT BAS

The BLITZDUCTOR XT base part is an extremely space-saving and universal four-pole **feed-through terminal** for the insertion of a protection module **without** signal disconnection if the protection module is removed. The snap-in mechanism at the supporting foot of the base part allows the protection module to be safely earthed via the DIN rail. Since no components of the protective circuit are situated in the base part, maintenance is only required for the protection modules.

Type	BXT BAS
Part No.	920 300
For mounting on	35 mm DIN rails acc. to EN 60715
Cross-sectional area, solid	0.08-4 mm ²
Cross-sectional area, flexible	0.08-2.5 mm ²
Tightening torque (terminals)	0.4 Nm
Earthing via	35 mm DIN rails acc. to EN 60715
Approvals	CSA, UL, EAC, ATEX, IECEx *)

*) only in connection with an approved protection module



BSP BAS 4

The BLITZDUCTOR SP base part is an extremely space-saving and universal four-pole **terminal** for the insertion of a protection module **with** signal disconnection if the protection module is removed. The snap-in mechanism at the supporting foot of the base part allows the protection module to be safely earthed via the DIN rail. Since no components of the protective circuit are situated in the base part, maintenance operation is only required for the protection modules.

Type	BSP BAS 4
Part No.	926 304
For mounting on	35 mm DIN rails acc. to EN 60715
Cross-sectional area, solid	0.08-4 mm ²
Cross-sectional area, flexible	0.08-2.5 mm ²
Tightening torque (terminals)	0.4 Nm
Earthing via	35 mm DIN rails acc. to EN 60715
Approvals	UL, CSA, EAC *)

*) only in connection with an approved protection module





BLITZDUCTOR XT

Pluggable SPDs –
DIN Rail Mounted



BLITZDUCTOR XT with an earthing module (grey). The lines can be tested by means of the measuring module (grey with lines) without disconnecting the terminals.

BLITZDUCTOR XT combined arresters are pluggable and universal multi-pole DIN rail mounted lightning current and surge arresters for protecting measuring and control circuits, bus systems and telecommunication systems. They are particularly useful in installations and systems with high requirements on availability. To ensure effective protection of terminal equipment under lightning and overvoltage conditions, BLITZDUCTOR XT arresters combine the permanently high impulse current discharge capacity of a lightning current arrester with the low voltage protection level of a surge arrester.

RFID LifeCheck technology allows quick and easy testing of arresters without removing the module from the system. Integrated in the protection modules, RFID LifeCheck permanently monitors the operating state of the arrester and acts like an early warning system, detecting imminent electrical or thermal overload of the protection components. The status of the arrester can be read in a second by the portable DEHNrecord LC reader

- **Combined lightning current and surge arrester**
 - Maximum discharge capacity for two-pole, three-pole or four-pole interfaces
 - Capable of carrying lightning currents up to 10 kA (10/350 μ s)
 - Low voltage protection level, capable of protecting terminal equipment
- **With integrated LifeCheck monitoring**
 - Arrester testing during operation
 - Detection of pre-damaged arresters
 - High signal availability thanks to preventive replacement of arresters
- **SPD consists of a protection module and a base part**
 - Vibration and shock-tested for safe operation
 - All protection components integrated in the protection module
 - Two universal base parts with / without signal disconnection
 - Minimum space requirements, 4 single lines or 2 pairs over a width of 12 mm

with non-contact RFID technology. RFID LifeCheck also saves and indicates the date of the last test of the protection module. A stationary condition monitoring system permanently monitors the condition of up to 10 BXT arresters.

The module locking system ensures safe operation. Thus, the arrester provides protection against vibration and shock up to a 30-fold acceleration of gravity. The function-optimised design of the arrester ensures both fast and easy replacement of the protection modules which house all relevant protection elements.

A wide range of accessories makes BLITZDUCTOR XT arresters particularly easy to use. Elements for earthing unused lines or easily testing signal circuits round off the product range.

The **protection module** and **base part** must be ordered separately!



Two-part design with universal base part and application-specific protection module.



The module locking mechanism ensures that the module is vibration-proof and protected against polarity reversal.



All protection elements are integrated in the plug-in module and are monitored by means of LifeCheck.



EMC spring terminal (accessory) for permanent low-impedance shield contact.

BLITZDUCTOR XT – Protection Modules with LifeCheck



BXT ML4 B 180

Space-saving four-pole lightning current arrester module with RFID LifeCheck feature for almost all applications. For use in connection with downstream **TYPE 2 P1** surge arresters or combined lightning current and surge arresters with a lower or equal voltage level.

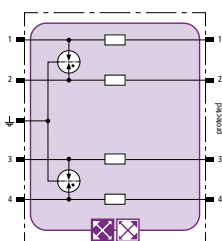

Type BXT ...	ML4 B 180
Part No.	920 310
SPD class	TYPE 1
Max. continuous operating voltage (d.c.) (U _c)	180 V
Nominal current at 45 °C (I _n)	1.2 A
D1 Total lightning impulse current (10/350 μ s) (I _{imp})	10 kA
C2 Total nominal discharge current (8/20 μ s) (I _n)	20 kA
Series resistance per line	0.4 ohm(s)
Approvals	CSA, EAC, ATEX, IECEx, CSA & USA Hazloc, SIL

BXT ML4 BE 5 – BE 180

Space-saving combined lightning current and surge arrester module with RFID LifeCheck for protecting four single lines sharing a common reference potential as well as unbalanced interfaces.

General technical data:				
D1 Total lightning impulse current (10/350 μ s) (I_{imp})	10 kA			
C2 Total nominal discharge current (8/20 μ s) (I_n)	20 kA			
Type BXT ...	ML4 BE 5	ML4 BE 12	ML4 BE 24	ML4 BE 36
Part No.	920 320	920 322	920 324	920 336
SPD class	TYPE 1 P1			
Max. continuous operating voltage (d.c.) (U_c)	6 V	15 V	33 V	45 V
Nominal current at 45 °C (I_l)	1.0 A	0.75 A	0.75 A	1.8 A
Series resistance per line	1.0 ohm(s)	1.8 ohm(s)	1.8 ohm(s)	0.43 ohm(s)
Cut-off frequency line-PG (f_c)	1.0 MHz	2.7 MHz	6.8 MHz	3.8 MHz
Approvals	CSA, UL, EAC, ATEX, IECEx, CSA & USA Hazloc, SIL	CSA, UL, EAC, ATEX, IECEx, CSA & USA Hazloc, SIL	CSA, UL, EAC, ATEX, IECEx, CSA & USA Hazloc, SIL	UL, EAC, ATEX, IECEx, CSA & USA Hazloc, SIL
Type BXT ...	ML4 BE 48	ML4 BE 60	ML4 BE 180	
Part No.	920 325	920 326	920 327	
SPD class	TYPE 1 P1		TYPE 1 P2	
Max. continuous operating voltage (d.c.) (U_c)	54 V	70 V	180 V	
Nominal current at 45 °C (I_l)	0.75 A	1.0 A	1.0 A	
Series resistance per line	1.8 ohm(s)	1.0 ohm(s)	1.0 ohm(s)	
Cut-off frequency line-PG (f_c)	8.7 MHz	9.0 MHz	25.0 MHz	
Approvals	CSA, UL, EAC, ATEX, IECEx, CSA & USA Hazloc, SIL	CSA, UL, EAC, ATEX, IECEx, CSA & USA Hazloc, SIL	CSA, UL, EAC, ATEX, IECEx, CSA & USA Hazloc, SIL	

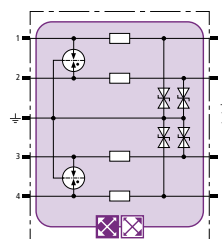

Pluggable SPDs –
DIN Rail Mounted

BXT ML4 BD 5 – BD 180

Space-saving combined lightning current and surge arrester module with RFID LifeCheck for protecting two pairs of unearthed balanced interfaces.

General technical data:			
D1 Total lightning impulse current (10/350 μ s) (I_{imp})	10 kA		
C2 Total nominal discharge current (8/20 μ s) (I_n)	20 kA		
Approvals	CSA, UL, EAC, ATEX, IECEx, CSA & USA Hazloc, SIL		
Type BXT ...	ML4 BD 5	ML4 BD 12	ML4 BD 24
Part No.	920 340	920 342	920 344
SPD class	TYPE 1 P1		
Max. continuous operating voltage (d.c.) (U_c)	6.0 V	15 V	33 V
Nominal current at 45 °C (I_l)	1.0 A	1.0 A	1.0 A
Series resistance per line	1.0 ohm(s)	1.0 ohm(s)	1.0 ohm(s)
Cut-off frequency line-line (f_c)	1.0 MHz	2.8 MHz	7.8 MHz
Type BXT ...	ML4 BD 48	ML4 BD 60	ML4 BD 180
Part No.	920 345	920 346	920 347
SPD class	TYPE 1 P1		TYPE 1 P2
Max. continuous operating voltage (d.c.) (U_c)	54 V	70 V	180 V
Nominal current at 45 °C (I_l)	1.0 A	1.0 A	0.75 A
Series resistance per line	1.0 ohm(s)	1.0 ohm(s)	1.8 ohm(s)
Cut-off frequency line-line (f_c)	8.7 MHz	11.0 MHz	25.0 MHz

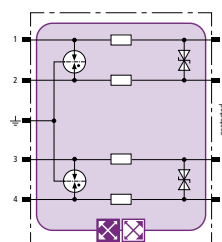

BXT ML4 BPD 24

Space-saving combined arrester module with RFID LifeCheck for protecting two pairs in 24 V d.c. systems. Can also be used for systems with earthed negative poles. Integrated PTC resistors allow the arrester to be safely reset after the system circuit has been affected by short-circuit currents up to 40 A.

Type BXT ...	ML4 BPD 24
Part No.	920 314
SPD class	TYPE 1 P1
Max. continuous operating voltage (d.c.) (U_c)	33 V
Nominal current at 70 °C (I_l)	0.1 A
D1 Total lightning impulse current (10/350 μ s) (I_{imp})	10 kA
C2 Total nominal discharge current (8/20 μ s) (I_n)	20 kA
Series resistance per line	typ. 10 ohm(s)
Cut-off frequency line-line (f_c)	4 MHz
Approvals	EAC, SIL

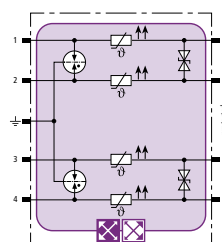



BXT ML4 BC 5 / 24

Space-saving combined lightning current and surge arrester module with RFID LifeCheck for protecting up to four unearthed single lines sharing a common reference potential.

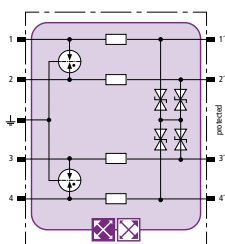

Type BXT ...	ML4 BC 5	ML4 BC 24
Part No.	920 350	920 354
SPD class	TYPE 1 P1	TYPE 1 P1
Max. continuous operating voltage (d.c.) (U _c)	6.0 V	33 V
Nominal current at 45 °C (I _n)	1.0 A	0.75 A
D1 Total lightning impulse current (10/350 μs) (I _{imp})	10 kA	10 kA
C2 Total nominal discharge current (8/20 μs) (I _n)	20 kA	20 kA
Series resistance per line	1.0 ohm(s)	1.8 ohm(s)
Cut-off frequency line-line (f _c)	1.0 MHz	5.7 MHz
Approvals	CSA, EAC, ATEX, IECEx, CSA & USA Hazloc, SIL	CSA, EAC, ATEX, IECEx, CSA & USA Hazloc, SIL



BXT ML4 BE C 12 / 24

Space-saving combined lightning current and surge arrester module with RFID LifeCheck for protecting two pairs of balanced interfaces with diode protective circuit at the input, current loops (TTY) and optocoupler inputs.

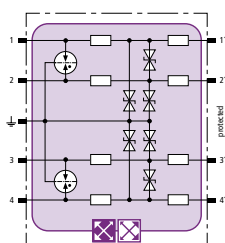

Type BXT ...	ML4 BE C 12	ML4 BE C 24
Part No.	920 362	920 364
SPD class	TYPE 1 P1	TYPE 1 P1
Max. continuous operating voltage (d.c.) (U _c)	15 V	33 V
Nominal current at 80 °C (I _n)	0.1 A	0.1 A
D1 Total lightning impulse current (10/350 μs) (I _{imp})	10 kA	10 kA
C2 Total nominal discharge current (8/20 μs) (I _n)	20 kA	20 kA
Series resistance per line	13.8 ohm(s)	28.8 ohm(s)
Cut-off frequency line-PG (f _c)	0.85 MHz	1.7 MHz
Approvals	EAC, ATEX, IECEx, CSA & USA Hazloc, SIL	CSA, EAC, ATEX, IECEx, CSA & USA Hazloc, SIL



BXT ML4 BE HF 5

Space-saving combined lightning current and surge arrester module with RFID LifeCheck for protecting four single lines sharing a common reference potential as well as high-frequency transmissions without galvanic isolation.

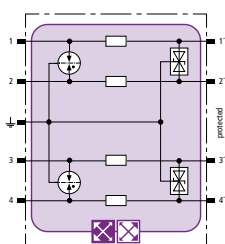

Type BXT ...	ML4 BE HF 5
Part No.	920 370
SPD class	TYPE 1 P1
Max. continuous operating voltage (d.c.) (U _c)	6.0 V
Nominal current at 45 °C (I _n)	1.0 A
D1 Total lightning impulse current (10/350 μs) (I _{imp})	10 kA
C2 Total nominal discharge current (8/20 μs) (I _n)	20 kA
Series resistance per line	1.0 ohm(s)
Cut-off frequency line-PG (f _c)	100.0 MHz
Approvals	CSA, UL, EAC, ATEX, IECEx, CSA & USA Hazloc, SIL



BXT ML4 BD HF 5 / 24

Space-saving combined lightning current and surge arrester module with RFID LifeCheck for protecting two pairs in unearthed high-frequency bus systems or two-wire video transmission systems.

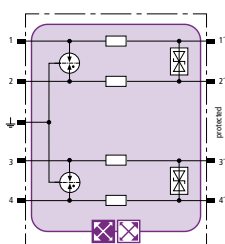

Type BXT ...	ML4 BD HF 5	ML4 BD HF 24
Part No.	920 371	920 375
SPD class	TYPE 1 P1	TYPE 1 P1
Max. continuous operating voltage (d.c.) (U _c)	6.0 V	33 V
Nominal current at 45 °C (I _n)	1.0 A	1.0 A
D1 Total lightning impulse current (10/350 μs) (I _{imp})	10 kA	10 kA
C2 Total nominal discharge current (8/20 μs) (I _n)	20 kA	20 kA
Series resistance per line	1.0 ohm(s)	1.0 ohm(s)
Cut-off frequency line-line (f _c)	100.0 MHz	100.0 MHz
Approvals	CSA, UL, EAC, ATEX, IECEx, CSA & USA Hazloc, SIL	CSA, UL, EAC, ATEX, IECEx, CSA & USA Hazloc, SIL

BXT ML4 MY 110 / 250

Space-saving surge arrester module with RFID LifeCheck for protecting four lines of stranded signal interfaces.

Type BXT ...	ML4 MY 110	ML4 MY 250
Part No.	920 388	920 389
SPD class	TYPE 2P2	TYPE 2P3
Max. continuous operating voltage (d.c.) line-line (U_C)	170 V	620 V
Max. continuous operating voltage (d.c.) line-PG (U_C)	85 V	320 V
Nominal current at 80 °C (I_N)	3.0 A	3.0 A
C2 Total nominal discharge current (8/20 μ s) (I_n)	10 kA	10 kA
Cut-off frequency line-line (f_C)	4.5 MHz	20.0 MHz
Approvals	EAC, SIL	EAC, SIL

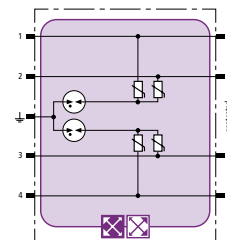

Pluggable SPDs –
DIN Rail Mounted

BXT ML4 BE BD 24

Space-saving surge arrester module with RFID LifeCheck for protecting two single lines with common reference potential as well as unbalanced interfaces and one pair of unearthed balanced interfaces.

Type BXT ...	ML4 BE BD 24
Part No.	920 334
SPD class	TYPE 1P1
Max. continuous operating voltage (d.c.) (U_C)	33 V
Nominal current at 45 °C (I_N)	0.75 A
D1 Total lightning impulse current (10/350 μ s) (I_{imp})	10 kA
C2 Total nominal discharge current (8/20 μ s) (I_n)	20 kA
Approvals	EAC

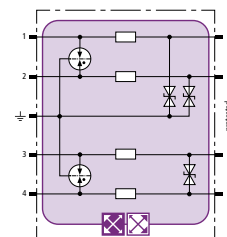

BXT ML2 BD 180

Space-saving combined lightning current and surge arrester module with RFID LifeCheck for protecting one pair of unearthed balanced interfaces.

Type BXT ...	ML2 BD 180
Part No.	920 247
SPD class	TYPE 1P2
Max. continuous operating voltage (d.c.) (U_C)	180 V
Nominal current at 45 °C (I_N)	0.75 A
D1 Total lightning impulse current (10/350 μ s) (I_{imp})	5 kA
C2 Total nominal discharge current (8/20 μ s) (I_n)	20 kA
Series resistance per line	1.8 ohm(s)
Cut-off frequency line-line (f_C)	25.0 MHz
Approvals	CSA, EAC, ATEX, IECEx, CSA & USA Hazloc, SIL

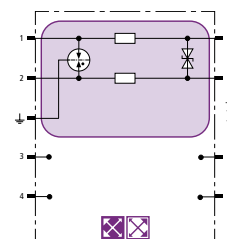

BXT ML2 BD S 5 – BD S 48

Space-saving combined lightning current and surge arrester module with RFID LifeCheck for protecting one pair of unearthed balanced interfaces, with direct or indirect shield earthing.

Type BXT ...	ML2 BD S 5	ML2 BD S 12	ML2 BD S 24	ML2 BD S 48
Part No.	920 240	920 242	920 244	920 245
SPD class	TYPE 1P1	TYPE 1P1	TYPE 1P1	TYPE 1P1
Max. continuous operating voltage (d.c.) (U_C)	6.0 V	15 V	33 V	54 V
Nominal current at 45 °C (I_N)	1.0 A	1.0 A	1.0 A	1.0 A
D1 Total lightning impulse current (10/350 μ s) (I_{imp})	9 kA	9 kA	9 kA	9 kA
C2 Total nominal discharge current (8/20 μ s) (I_n)	20 kA	20 kA	20 kA	20 kA
Series resistance per line	1.0 ohm(s)	1.0 ohm(s)	1.0 ohm(s)	1.0 ohm(s)
Cut-off frequency line-line (f_C)	1.0 MHz	2.8 MHz	7.8 MHz	8.7 MHz
Approvals	CSA, EAC, ATEX, IECEx, CSA & USA Hazloc, SIL	CSA, EAC, ATEX, IECEx, CSA & USA Hazloc, SIL	CSA, EAC, ATEX, IECEx, CSA & USA Hazloc, SIL	CSA, EAC, ATEX, IECEx, CSA & USA Hazloc, SIL

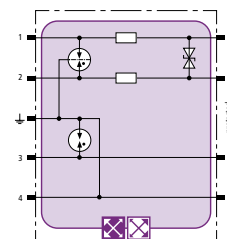

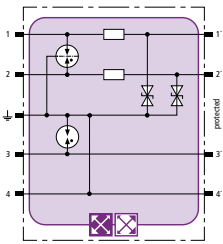

BXT ML2 BE S 5 – BE S 48

Space-saving combined lightning current and surge arrester module with RFID LifeCheck for protecting two single lines sharing a common reference potential as well as unbalanced interfaces, with direct or indirect shield earthing.

General technical data:			
SPD class	TYPE 1 P1		
D1 Total lightning impulse current (10/350 μs) (I _{imp})	9 kA		
C2 Total nominal discharge current (8/20 μs) (I _n)	20 kA		
Type BXT ...	ML2 BE S 5	ML2 BE S 12	ML2 BE S 24
Part No.	920 220	920 222	920 224
Max. continuous operating voltage (d.c.) (U _C)	6.0 V	15 V	33 V
Nominal current at 45 °C (I _N)	1.0 A	0.75 A	0.75 A
Series resistance per line	1.0 ohm(s)	1.8 ohm(s)	1.8 ohm(s)
Cut-off frequency line-PG (f _C)	1.0 MHz	2.7 MHz	6.8 MHz
Approvals	CSA, EAC, ATEX, IECEx, CSA & USA Hazloc, SIL		
Type BXT ...	ML2 BE S 36	ML2 BE S 48	
Part No.	920 226	920 225	
Max. continuous operating voltage (d.c.) (U _C)	45 V	54 V	
Nominal current at 45 °C (I _N)	1.8 A	0.75 A	
Series resistance per line	0.43 ohm(s)	1.8 ohm(s)	
Cut-off frequency line-PG (f _C)	3.8 MHz	8.7 MHz	
Approvals	UL, EAC, SIL	CSA, UL, EAC, ATEX, IECEx, CSA & USA Hazloc, SIL	

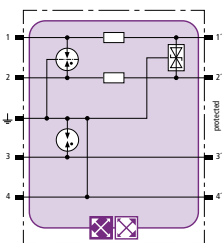

BXT ML2 BE HFS 5

Space-saving combined lightning current and surge arrester module with RFID LifeCheck for protecting one pair in high-frequency transmissions without galvanic isolation, with direct or indirect shield earthing.

Type BXT ...	ML2 BE HFS 5
Part No.	920 270
SPD class	TYPE 1 P1
Max. continuous operating voltage (d.c.) (U _C)	6.0 V
Nominal current at 45 °C (I _N)	1.0 A
D1 Total lightning impulse current (10/350 μs) (I _{imp})	9 kA
C2 Total nominal discharge current (8/20 μs) (I _n)	20 kA
Series resistance per line	1.0 ohm(s)
Cut-off frequency line-PG (f _C)	100.0 MHz
Approvals	CSA, UL, EAC, ATEX, IECEx, CSA & USA Hazloc, SIL

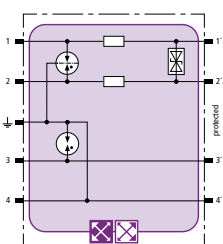

BXT ML2 BD HFS 5

Space-saving combined lightning current and surge arrester module with RFID LifeCheck for protecting one pair in unearthed high-frequency bus systems or video transmission systems, with direct or indirect shield earthing.

Type BXT ...	ML2 BD HFS 5
Part No.	920 271
SPD class	TYPE 1 P1
Max. continuous operating voltage (d.c.) (U _C)	6.0 V
Nominal current at 45 °C (I _N)	1.0 A
D1 Total lightning impulse current (10/350 μs) (I _{imp})	9 kA
C2 Total nominal discharge current (8/20 μs) (I _n)	20 kA
Series resistance per line	1.0 ohm(s)
Cut-off frequency line-line (f _C)	100.0 MHz
Approvals	CSA, UL, EAC, ATEX, IECEx, CSA & USA Hazloc, SIL

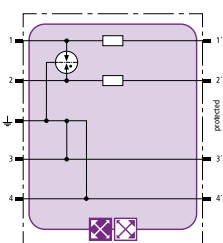

BXT ML2 B 180

Space-saving two-pole lightning current arrester module with RFID LifeCheck and shield earthing for almost all applications. For use in conjunction with downstream TYPE 2 P1 surge arresters or combined lightning current and surge arresters with a lower or equal voltage level.

Type BXT ...	ML2 B 180
Part No.	920 211
SPD class	TYPE 1 P2
Max. continuous operating voltage (d.c.) (U _C)	180 V
Nominal current at 45 °C (I _N)	1.2 A
D1 Total lightning impulse current (10/350 μs) (I _{imp})	10 kA
C2 Total nominal discharge current (8/20 μs) (I _n)	20 kA
Series resistance per line	0.4 ohm(s)
Approvals	CSA, EAC, ATEX, IECEx, CSA & USA Hazloc, SIL

BXT ML2 BD DL S 15

Space-saving combined lightning current and surge arrester module with RFID LifeCheck for protecting one pair of unearthed balanced interfaces, which specifically fulfils the requirements of Dupline buses, direct or indirect shield earthing.

Type BXT ...	ML2 BD DL S 15
Part No.	920 243
SPD class	TYPE 1P1
Max. continuous operating voltage (d.c.) (U_C)	17 V
Nominal current at 70 °C (I_N)	0.4 A
D1 Total lightning impulse current (10/350 μ s) (I_{imp})	9 kA
C2 Total nominal discharge current (8/20 μ s) (I_n)	20 kA
Series resistance per line	2.2 ohm(s)
Cut-off frequency line-line (f_C)	2.7 MHz
Approvals	EAC, ATEX, IECEx, CSA & USA Hazloc, SIL

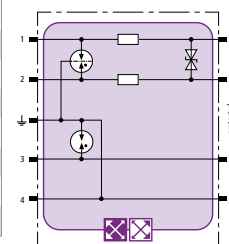

BXT ML2 MY 250

Space-saving surge arrester module with RFID LifeCheck for protecting two lines of stranded signal interfaces up to 250 V a.c.

Type BXT ...	ML2 MY 250
Part No.	920 289
SPD class	TYPE 2P2
Max. continuous operating voltage (d.c.) line-line (U_C)	620 V
Max. continuous operating voltage (d.c.) line-PG (U_C)	320 V
Nominal current at 80 °C (I_N)	3.0 A
C2 Total nominal discharge current (8/20 μ s) (I_n)	5 kA
Cut-off frequency line-line (f_C)	20.0 MHz
Approvals	EAC, SIL

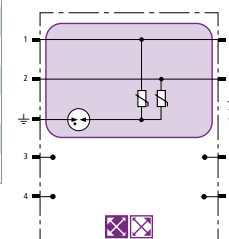

BXT ML2 MY E 110

Space-saving surge arrester module with RFID LifeCheck for protecting two pairs of stranded signal interfaces.

Type BXT ...	ML2 MY E 110
Part No.	920 288
SPD class	TYPE 2P2
Max. continuous operating voltage (d.c.) line-line (U_C)	170 V
Max. continuous operating voltage (d.c.) line-PG (U_C)	85 V
Nominal current at 80 °C (I_N)	3.0 A
C2 Total nominal discharge current (8/20 μ s) (I_n)	5 kA
Series resistance per line	0 ohm(s)
Cut-off frequency line-line (f_C)	4.5 MHz
Approvals	EAC, SIL

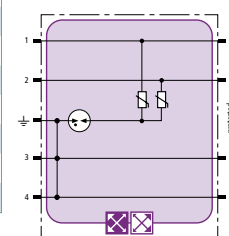

BLITZDUCTOR XT – Protection Module

BXT M2 BD HC5A 24

Space-saving combined arrester module for protecting one pair of unearthed balanced interfaces. Module is adapted to interfaces with direct currents up to 5 A, e.g. for the controller of motor-driven actuators with high starting and operating currents.

Type BXT ...	M2 BD HC5A 24
Part No.	920 296
SPD class	TYPE 1P1
Max. continuous operating voltage (d.c.) (U_C)	36 V
Nominal current (I_N)	5 A
D1 Total lightning impulse current (10/350 μ s) (I_{imp})	5 kA
C2 Total nominal discharge current (8/20 μ s) (I_n)	20 kA
Series resistance per line	0 ohm(s)
Approvals	SIL

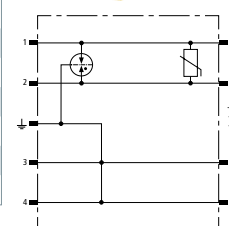



BLITZDUCTOR XTU

Pluggable SPDs –
DIN Rail Mounted



BLITZDUCTOR XTU for protecting different balanced signal and data interfaces. Space-saving two-part design comprising a base part and a protection module for DIN rail mounting.

The compact BLITZDUCTOR XTU combined lightning current and surge arrester is designed for protecting information and automation equipment and systems and distinguishes itself through its unique actiVsense technology. The arrester does not have a specific nominal voltage and can thus be used for all voltages from 0 to 180 V with a superimposed signal voltage (± 5 V/50 MHz). The nominal current is limited to 100 mA which is completely sufficient for information technology applications.

Its innovative actiVsense technology allows the arrester to detect the signal voltage and to automatically adapt the voltage protection level to this voltage. This makes the arrester ideal for applications where changing or slowly fluctuating signal levels (≤ 400 Hz) are to be expected. In case of interference, BLITZDUCTOR XTU arresters always provide a minimal residual voltage for every signal voltage and therefore afford maximum protection for the devices and system circuits connected to them.

BLITZDUCTOR XTU is available in two versions. The four-pole version provides protection for two separate balanced interfaces, i.e. the arrester automatically detects the operating/signal voltage for every pair and optimally adapts the voltage protection level for every signal circuit. This makes it possible to protect two different balanced interfaces with a single arrester, thus reducing installation time, saving costs and reducing the variety of arresters required. If only one signal interface is to be protected, a two-pole version can be used for a balanced data interface (one pair). This version also provides the option of connecting cable shields either directly or indirectly to the equipotential bonding.

- **Combined lightning current and surge arrester**
 - Max. discharge capacity for balanced data interfaces
 - Capable of carrying lightning currents up to 10 kA (10/350 μ s)
 - For installation in conformity with the lightning protection zone concept at the boundaries from $0_A - 2$ and higher
- **With actiVsense technology**
 - Automatically detects the signal voltage ranging from 0 to 180 V
 - Optimally adapts the voltage protection level to the currently applied signal
 - Capable of protecting terminal equipment due to adapted voltage protection level
 - One arrester type for two different data interfaces
- **Integrated RFID LifeCheck monitoring function**
 - Arresters can be tested without downtime
 - Detection of pre-damaged arresters
 - High signal availability due to preventive replacement of arresters
- **Arrester consists of a protection module and a base part**
 - For DIN rail mounting with a standard base part
 - Easy replacement of protection modules
 - Vibration and shock-tested for safe operation
 - Two universal base parts with / without signal disconnection

This DIN rail mounted arrester is ideally suited for use in information technology transmission systems such as telecommunication, bus or measuring and control systems.

The **protection module** and **base part** must be ordered separately!

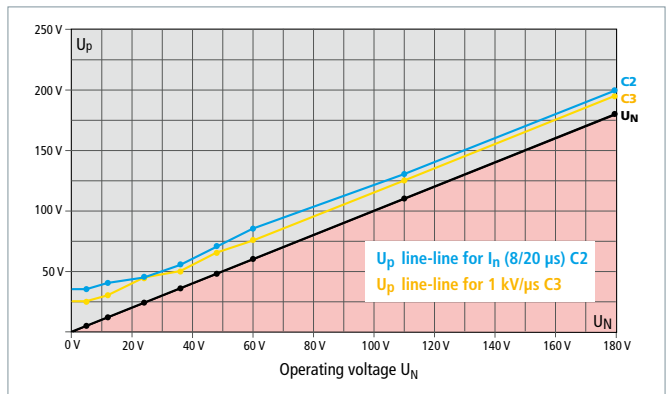

Voltage protection level diagram BXTU



Optimally adapted voltage protection level with integrated actiVsense technology ensures protection of terminal equipment.



The protection module of the pluggable arrester safely snaps into the base part, thus ensuring vibration and shock resistance.



To ensure high availability of the signal circuits, the integrated LifeCheck feature a quick check of whether the arrester is pre-damaged.



DIN rail mounting by means of integrated earthing contact.

BLITZDUCTOR XTU – Protection Modules with LifeCheck

BXTU ML4 BD 0-180

Space-saving combined lightning current and surge arrester module with actiVsense technology and RFID LifeCheck for protecting two pairs (same or different operating voltage) of balanced interfaces with galvanic isolation.

Type BXTU ...	ML4 BD 0-180
Part No.	920 349
SPD class	TYPE 1 Pt1
Max. continuous operating voltage (d.c.) (U_c)	180 V
Permissible superimposed signal voltage (U_{signal})	$\leq \pm 5$ V
Cut-off frequency line-line (U_{signal} , balanced 100 ohms) (f_G)	50 MHz
Nominal current at 80 °C (equal to max. short-circuit current) (I_n)	100 mA
D1 Total lightning impulse current (10/350 μ s) (I_{imp})	10 kA
C2 Total nominal discharge current (8/20 μ s) (I_n)	20 kA
Series resistance per line	≤ 10 ohms; typically 7.5 ohms
Approvals	CSA, UL, EAC, SIL

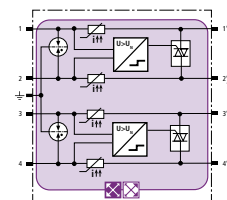

Pluggable SPDs –
DIN Rail Mounted

BXTU ML2 BD S 0-180

Space-saving combined lightning current and surge arrester module with actiVsense technology and RFID LifeCheck for protecting one pair of balanced interfaces with galvanic isolation. Direct or indirect shield earthing.

Type BXTU ...	ML2 BD S 0-180
Part No.	920 249
SPD class	TYPE 1 Pt1
Max. continuous operating voltage (d.c.) (U_c)	180 V
Permissible superimposed signal voltage (U_{signal})	$\leq \pm 5$ V
Cut-off frequency line-line (U_{signal} , balanced 100 ohms) (f_G)	50 MHz
Nominal current at 80 °C (equal to max. short-circuit current) (I_n)	100 mA
D1 Total lightning impulse current (10/350 μ s) (I_{imp})	9 kA
C2 Total nominal discharge current (8/20 μ s) (I_n)	20 kA
Series resistance per line	≤ 10 ohms; typically 7.5 ohms
Approvals	CSA, UL, EAC, SIL

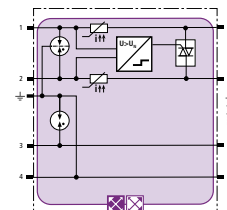



BLITZDUCTOR SP

Pluggable SPDs –
DIN Rail Mounted



Pluggable and universal multipole surge arrester for use in information technology systems.

BLITZDUCTOR SP arresters are pluggable and universal multipole DIN rail mounted surge arresters for protecting measuring and control circuits, bus systems, emergency alarm systems or telecommunication systems. BLITZDUCTOR SP arresters combine a permanently high impulse current discharge capacity with an extremely low voltage protection level, thus ensuring effective protection of terminal equipment even in case of interference caused by impulse currents and surges resulting from switching operations.

- **Universal surge arrester**
 - Universal surge arrester for two-pole, three-pole or four-pole interfaces
 - High discharge capacity up to 20 kA (8/20 μs)
 - Low voltage protection level, capable of protecting terminal equipment
- **Arrester consists of a protection module and a base part**
 - Easy replacement of protection modules
 - All protection components integrated in the protection module
 - Two universal base parts with or without signal disconnection
- **Functional and attractive design**
 - DIN rail mounted device with integrated earthing
 - Minimum space requirements, four single lines or two pairs over a width 12 mm
 - Vibration and shock-tested for safe operation



For safe operation, the arrester is vibration and shock tested and resists up to 30 times the acceleration of gravity. The function-optimised arrester design ensures both fast and easy replacement of the protection modules which house all relevant protection elements.

A wide range of accessories, e.g. for earthing unused lines or easily testing lines round off the product range.

The **protection module** and **base part** have to be ordered separately!



Two-part design comprising a base part and a protection module.



The module locking mechanism ensures that the module is vibration-proof and protected against polarity reversal.



All protection elements are integrated in the plug-in module.



Two universal base parts with or without signal disconnection if the protection module is removed.

BLITZDUCTOR SP – Protection Modules

BSP M4 BE 5 – BE 180

Space-saving surge arrester module for protecting four single lines sharing a common reference potential and unbalanced interfaces.

General technical data:

D1 Lightning impulse current (10/350 μs) per line (I _{imp})	1 kA
C2 Total nominal discharge current (8/20 μs) (I _n)	20 kA

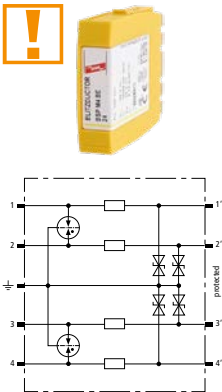

Type BSP ...	M4 BE 5	M4 BE 12	M4 BE 24
Part No.	926 320 [1]	926 322 [1]	926 324 [1]
SPD class	TYPE 2 P1	TYPE 2 P1	TYPE 2 P1
Max. continuous operating voltage (d.c.) (U _c)	6.0 V	15 V	33 V
Nominal current at 45 °C (I _n)	1.0 A	0.75 A	0.75 A
Cut-off frequency line-PG (f _c)	1.0 MHz	2.7 MHz	6.8 MHz
Approvals	UL, CSA, SIL, EAC	UL, CSA, SIL, EAC	UL, CSA, SIL, EAC
Type BSP ...	M4 BE 48	M4 BE 180	
Part No.	926 325 [1]	926 327 [1]	
SPD class	TYPE 2 P1	TYPE 2 P2	
Max. continuous operating voltage (d.c.) (U _c)	54 V	180 V	
Nominal current at 45 °C (I _n)	0.75 A	1.0 A	
Cut-off frequency line-PG (f _c)	8.7 MHz	25.0 MHz	
Approvals	UL, CSA, SIL, EAC	UL, CSA, SIL, EAC	

BSP M4 BD 5 – BD 180

Space-saving surge arrester module for protecting two pairs of balanced interfaces with galvanic isolation.

General technical data:			
D1 Lightning impulse current (10/350 μ s) per line (I_{imp})	1 kA		
C2 Total nominal discharge current (8/20 μ s) (I_n)	20 kA		
Approvals	UL, CSA, SIL, EAC		
Type BSP ...	M4 BD 5	M4 BD 12	M4 BD 24
Part No.	926 340	926 342	926 344
SPD class	TYPE 2 P1		
Max. continuous operating voltage (d.c.) (U_c)	6.0 V	15 V	33 V
Nominal current at 45 °C (I_l)	1.0 A	1.0 A	1.0 A
Cut-off frequency line-line (f_G)	1.0 MHz	2.8 MHz	7.8 MHz
Type BSP ...	M4 BD 48	M4 BD 180	
Part No.	926 345	926 347	
SPD class	TYPE 2 P1		
Max. continuous operating voltage (d.c.) (U_c)	54 V	180 V	
Nominal current at 45 °C (I_l)	1.0 A	0.75 A	
Cut-off frequency line-line (f_G)	8.7 MHz	25.0 MHz	

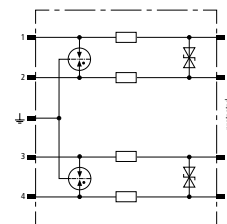

Pluggable SPDs –
DIN Rail Mounted

BSP M4 BE HF 5

Space-saving surge arrester module for protecting four single lines sharing a common reference potential and high-frequency transmissions without galvanic isolation.

Type BSP ...	M4 BE HF 5
Part No.	926 370
SPD class	TYPE 2 P1
Max. continuous operating voltage (d.c.) (U_c)	6.0 V
Nominal current at 45 °C (I_l)	1.0 A
D1 Lightning impulse current (10/350 μ s) per line (I_{imp})	1 kA
C2 Total nominal discharge current (8/20 μ s) (I_n)	20 kA
Cut-off frequency line-PG (f_G)	100.0 MHz
Approvals	UL, CSA, SIL, EAC

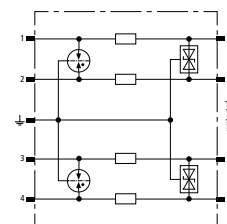

BSP M2 BE 5 – BE 180

Space-saving surge arrester module for protecting two single lines sharing a common reference potential and unbalanced interfaces.

General technical data:			
D1 Lightning impulse current (10/350 μ s) per line (I_{imp})	1 kA		
C2 Total nominal discharge current (8/20 μ s) (I_n)	20 kA		
Approvals	UL, CSA, SIL, EAC		
Type BSP ...	M2 BE 5	M2 BE 12	M2 BE 24
Part No.	926 220	926 222	926 224
SPD class	TYPE 2 P1		
Max. continuous operating voltage (d.c.) (U_c)	6.0 V	15 V	33 V
Nominal current at 45 °C (I_l)	1.0 A	0.75 A	0.75 A
Cut-off frequency line-PG (f_G)	1.0 MHz	2.7 MHz	6.8 MHz
Type BSP ...	M2 BE 48	M2 BE 180	
Part No.	926 225	926 227	
SPD class	TYPE 2 P1		
Max. continuous operating voltage (d.c.) (U_c)	54 V	180 V	
Nominal current at 45 °C (I_l)	0.75 A	1.0 A	
Cut-off frequency line-PG (f_G)	8.7 MHz	25 MHz	

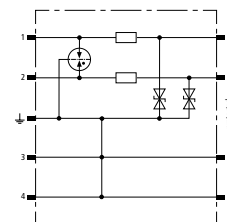



BSP M4 BD HF 5 / 24

Space-saving surge arrester module for protecting two pairs of high-frequency bus systems or video transmission systems with galvanic isolation.

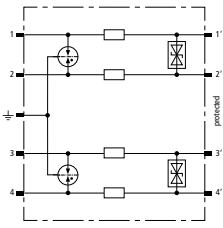

Type BSP ...	M4 BD HF 5	M4 BD HF 24
Part No.	926 371	926 375
SPD class	TYPE 2 P1	TYPE 2 P1
Max. continuous operating voltage (d.c.) (U _c)	6.0 V	33 V
Nominal current at 45 °C (I _n)	1.0 A	1.0 A
D1 Lightning impulse current (10/350 μs) per line (I _{imp})	1 kA	1 kA
C2 Total nominal discharge current (8/20 μs) (I _n)	20 kA	20 kA
Cut-off frequency line-line (f _c)	100.0 MHz	100.0 MHz
Approvals	UL, CSA, SIL, EAC	UL, CSA, EAC

Pluggable SPDs – DIN Rail Mounted

BSP M2 BD 5 – BD 180

Space-saving surge arrester module for protecting one pair of balanced interfaces with galvanic isolation.



General technical data:	
D1 Lightning impulse current (10/350 μs) per line (I _{imp})	1 kA
C2 Total nominal discharge current (8/20 μs) (I _n)	20 kA
Approvals	UL, CSA, SIL, EAC

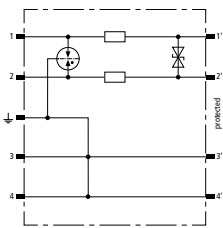

Type BSP ...	M2 BD 5	M2 BD 12	M2 BD 24
Part No.	926 240	926 242	926 244
SPD class	TYPE 2 P1	TYPE 2 P1	TYPE 2 P1
Max. continuous operating voltage (d.c.) (U _c)	6.0 V	15 V	33 V
Nominal current at 45 °C (I _n)	1.0 A	1.0 A	1.0 A
Cut-off frequency line-line (f _c)	1.0 MHz	2.8 MHz	7.8 MHz
Type BSP ...	M2 BD 48	M2 BD 60	M2 BD 180
Part No.	926 245	926 246	926 247
SPD class	TYPE 2 P1	TYPE 2 P1	TYPE 2 P2
Max. continuous operating voltage (d.c.) (U _c)	54 V	70 V	180 V
Nominal current at 45 °C (I _n)	1.0 A	1.0 A	0.75 A
Cut-off frequency line-line (f _c)	8.7 MHz	11 MHz	25.0 MHz



BSP M2 BE HF 5

Space-saving surge arrester module for protecting two single lines sharing a common reference potential and high-frequency transmissions without galvanic isolation.

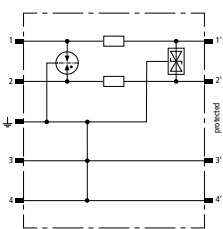

Type BSP ...	M2 BE HF 5
Part No.	926 270
SPD class	TYPE 2 P1
Max. continuous operating voltage (d.c.) (U _c)	6.0 V
Nominal current at 45 °C (I _n)	1.0 A
D1 Lightning impulse current (10/350 μs) per line (I _{imp})	1 kA
C2 Total nominal discharge current (8/20 μs) (I _n)	20 kA
Cut-off frequency line-PG (f _c)	100 MHz
Approvals	UL, CSA, SIL, EAC



BSP M2 BD HF 5 / 24

Space-saving surge arrester module for protecting one pair of high-frequency bus systems or video transmission systems with galvanic isolation.

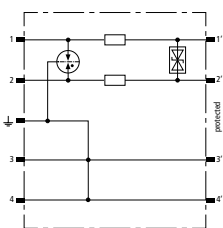

Type BSP ...	M2 BD HF 5	M2 BD HF 24
Part No.	926 271	926 275
SPD class	TYPE 2 P1	TYPE 2 P1
Max. continuous operating voltage (d.c.) (U _c)	6.0 V	33 V
Nominal current at 45 °C (I _n)	1.0 A	1.0 A
D1 Lightning impulse current (10/350 μs) per line (I _{imp})	1 kA	1 kA
C2 Total nominal discharge current (8/20 μs) (I _n)	20 kA	20 kA
Cut-off frequency line-line (f _c)	100 MHz	100 MHz
Approvals	UL, CSA, SIL, EAC	UL, CSA, EAC



BLITZDUCTOR XT Ex (i)

- Surge arrester for intrinsically safe measuring circuits and bus systems
 - Maximum discharge capacity for two-pole, three-pole or four-pole interfaces
 - Low voltage protection level, capable of protecting terminal equipment
 - Wide range of approvals: ATEX, IECEx, CSA Hazloc
- Arrester consists of a protection module and a base part
 - Easy replacement of protection modules without force
 - All protection components are integrated in the protection module
 - Arrester with integrated RFID LifeCheck for preventive arrester monitoring
- Functional and attractive design
 - DIN rail mounted arrester with integrated earthing
 - Minimum space requirements, two pairs over a width of 12 mm
 - Vibration and shock-tested for safe operation

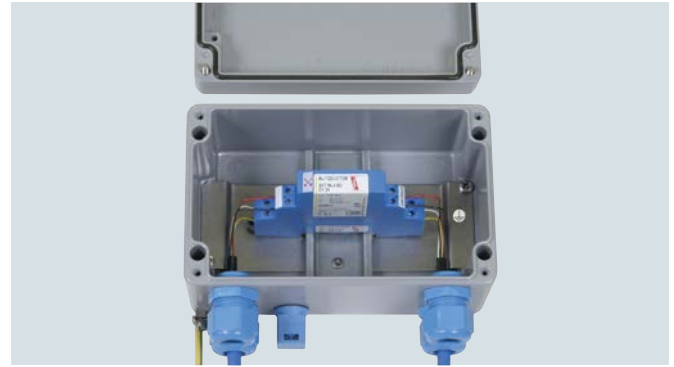

Pluggable and universal multipole surge arrester for use in intrinsically safe systems with integrated LifeCheck monitoring function.

BLITZDUCTOR XT EX is a pluggable and universal four-pole DIN rail mounted surge arrester designed for the most stringent requirements on the availability of intrinsically safe measuring and control circuits and bus systems.

For the purpose of intrinsic safety, the arrester is considered to be un-earthed and its self-inductance and self-capacitance are negligibly small. The low-impedance arrester design ensures a high impulse current discharge capacity (at least 10x) and a low voltage protection level.

RFID LifeCheck allows quick and easy arrester testing. However, the hand-held DRC LC reader may only be used to read the protection modules in non-explosive atmospheres.

Integrated in the protection modules, RFID LifeCheck permanently monitors the operating state of the arrester. Like an early warning system, RFID

LifeCheck detects imminent electrical or thermal overload of the protection components. The LifeCheck status can be read in just seconds by the hand-held DEHNrecord LC reader via non-contact RFID technology. Moreover, the date of the last test of the protection module can be displayed and saved. When permanently installed, a condition monitoring system allows condition-based maintenance of 10 BXT arresters.

For safe operation, the arrester is vibration and shock tested and resists up to 30 times the acceleration of gravity. The function-optimised arrester design allows quick and easy replacement of protection modules which house all relevant protection elements.

The **protection module** and **base part** must be ordered separately!



Two-part design comprising a universal base part and an application-specific protection module.



The module locking mechanism ensures that the module is vibration-proof and protected against polarity reversal.



All protection elements are integrated in the plug-in module and are monitored by means of LifeCheck.



Prewired surge arrester unit ITAK EXI BXT 24.

BLITZDUCTOR XT Ex (i) – Base Part

Base part without signal disconnection

- Universal base part for protection modules of the BLITZDUCTOR XT Ex (i) series
- No signal disconnection if the protection module is removed
- Connection of up to four lines

BXT BAS EX

BLITZDUCTOR XT base part for use as an extremely space-saving and universal four-pole feed-through terminal for intrinsically safe circuits for the insertion of the protection module, no signal disconnection if the protection module is removed. The snap-in mechanism at the supporting foot of the base part allows the device to be safely earthed via the DIN rail. Since no components of the protective circuit are situated in the base part, only the protection modules need to be serviced.

Type	BXT BAS EX
Part No.	920 301
For mounting on	35 mm DINs rails acc. to EN 60715
Cross-sectional area, solid	0.08-4 mm ²
Cross-sectional area, flexible	0.08-2.5 mm ²
Tightening torque (terminals)	0.4 Nm
Earthing via	35 mm DIN rails acc. to EN 60715
Approvals	UL, CSA, EACEx, ATEX, IECEx, Inmetro *)



*) only in connection with an approved protection module



BLITZDUCTOR XT Ex (i) – Protection Modules with LifeCheck

Pluggable SPDs –
DIN Rail Mounted

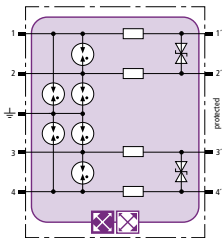

BXT ML4 BD EX 24

Space-saving surge arrester module with RFID LifeCheck for protecting two pairs in intrinsically safe measuring circuits and bus systems.

Type BXT ...	ML4 BD EX 24
Part No.	920 381
SPD class	TYPE 2 Pt1
Max. continuous operating voltage (d.c.) (U_c)	33 V
Max. input current acc. to EN 60079-11 (I_i)	0.5 A
D1 Total lightning impulse current (10/350 μ s) (I_{imp})	4 kA
D1 Lightning impulse current (10/350 μ s) per line (I_{imp})	1 kA
C2 Total nominal discharge current (8/20 μ s) (I_n)	20 kA
Cut-off frequency line-line (f_G)	7.7 MHz
Approvals *)	CSA, EACEx, ATEX, IECEx, CSA & USA Hazloc, SIL, Inmetro

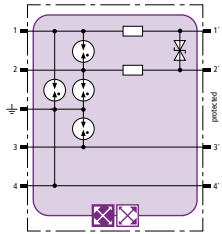

BXT ML2 BD S EX 24

Space-saving surge arrester module with RFID LifeCheck for protecting one pair in intrinsically safe measuring circuits and bus systems, direct or indirect shield earthing.

Type BXT ...	ML2 BD S EX 24
Part No.	920 280
SPD class	TYPE 2 Pt1
Max. continuous operating voltage (d.c.) (U_c)	33 V
Max. input current acc. to EN 60079-11 (I_i)	0.5 A
D1 Total lightning impulse current (10/350 μ s) (I_{imp})	4 kA
D1 Lightning impulse current (10/350 μ s) per line (I_{imp})	1 kA
C2 Total nominal discharge current (8/20 μ s) (I_n)	10 kA
Cut-off frequency line-line (f_G)	6 MHz
Approvals *)	EACEx, ATEX, IECEx, CSA & USA Hazloc, SIL, Inmetro

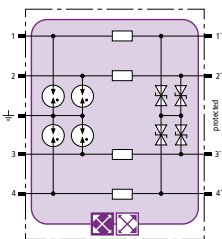

BXT ML4 BC EX 24

Space-saving surge arrester module with RFID LifeCheck for protecting up to four unearthed single lines sharing a common reference potential in intrinsically safe measuring circuits.

Type BXT ...	ML4 BC EX 24
Part No.	920 384
SPD class	TYPE 2 Pt1
Max. continuous operating voltage (d.c.) (U_c)	33 V
Max. input current acc. to EN 60079-11 (I_i)	0.5 A
D1 Total lightning impulse current (10/350 μ s) (I_{imp})	4 kA
D1 Lightning impulse current (10/350 μ s) per line (I_{imp})	1 kA
C2 Total nominal discharge current (8/20 μ s) (I_n)	20 kA
Cut-off frequency line-line (f_G)	6.4 MHz
Approvals *)	CSA, EACEx, ATEX, IECEx, CSA & USA Hazloc, SIL, Inmetro

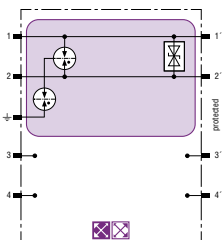

BXT ML2 BD HF EX 6

Space-saving surge arrester module with RFID LifeCheck for protecting intrinsically safe measuring circuits and RS485 bus systems.

Type BXT ...	ML2 BD HF EX 6
Part No.	920 538
SPD class	TYPE 2 Pt1
Max. continuous operating voltage (d.c.) (U_c)	6 V
Max. input current acc. to EN 60079-11 (I_i)	4.8 A
D1 Lightning impulse current (10/350 μ s) per line (I_{imp})	1 kA
C2 Total nominal discharge current (8/20 μ s) (I_n)	10 kA
Cut-off frequency line-line (f_G)	100 MHz
Approvals *)	EACEx, ATEX, IECEx, CSA & USA Hazloc, SIL, Inmetro

BLITZDUCTOR XT Ex (i) – Protection Module

BXT M2 BD S EX 24

Space-saving surge arrester module for protecting one pair in intrinsically safe measuring circuits and bus systems, direct or indirect shield earthing.

Type BXT ...	M2 BD S EX 24
Part No.	920 383
SPD class	TYPE 2 Pt1
Max. continuous operating voltage (d.c.) (U _c)	36 V
Max. input current acc. to EN 60079-11 (I _i)	0.5 A
D1 Total lightning impulse current (10/350 μs) (I _{imp})	4 kA
D1 Lightning impulse current (10/350 μs) per line (I _{imp})	1 kA
C2 Total nominal discharge current (8/20 μs) (I _n)	10 kA
Cut-off frequency line-line (f _G)	7.7 MHz
Approvals *)	ATEX, IECEx, CSA & USA Hazloc, SIL

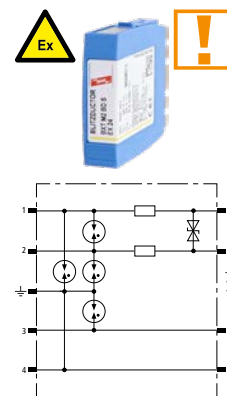

Pluggable SPDs –
DIN Rail Mounted

Accessories for BLITZDUCTOR XT Ex (i)

Partition

Allows to position devices of the BXT family for non-intrinsically safe circuits directly next to intrinsically safe circuits (thread measure ≥ 50 mm). For DRC MCM XT and DRC SCM XT; 1 set = 2 pieces.

Type	TW DRC MCM EX
Part No.	910 697
For mounting on	35 mm DIN rails according to EN 60715



ITAK Ex (i)

ITAK EXI BXT

BXT ML4 BD EX 24 and BXT BAS EX completely mounted. ATEX, FISCO.

Type	ITAK EXI BXT 24
Part No.	989 408
SPD class	TYPE 2 Pt1
Max. continuous operating voltage (d.c.) (U _c)	33 V
Max. input current acc. EN 60079-11 (I _i)	0.5 A
Total nominal discharge current (8/20 μs) (I _n)	20 kA
Cut-off frequency line-line (f _G)	7.7 MHz
Degree of protection	IP 65
Approvals for installed BXT	CSA, EACEx, ATEX, IECEx, CSA & USA Hazloc, SIL

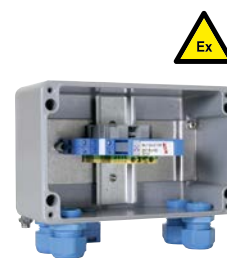

Accessories for BLITZDUCTOR XT/XTU/SP/XT Ex (i)

Earthing Module

The plugged-in earthing module connects all lines connected to the BLITZDUCTOR SP/XT/XTU base part to the equipotential bonding. It directly earths unused cable cores that are already connected to the base part.



Type	BXT M4 E
Part No.	920 308
D1 Total lightning impulse current (10/350 μs) (I _{imp})	10 kA
Plugs into	base part

Test / Disconnection Module

The plugged-in test / disconnection module interrupts the cable run of the lines connected to the BLITZDUCTOR SP / XT / XTU base part and leads them to a test socket at the front of the module. This allows measurements to be carried out in the installation without removing the lines from the base part.



Type	BXT M4 T
Part No.	920 309
Max. continuous operating voltage (d.c.) (U _c)	180 V
Nominal current at 80 °C (I _n)	1.0 A
Volume resistance	0.1 ohms
Plugs into	base part
Test sockets	gold-plated, 1 mm
Accessories	2 measuring lines (1 m), protective bag

Labelling System BA1-BA15

2x 165 adhesive labels for labelling DRC MCM XT monitoring devices with the bus address (BA1 to BA15) and BXT modules with consecutive numbers (1.1-1.10 to 15.1-15.10).

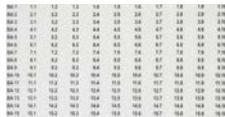

Type	BS BA1 BA15 BXT
Part No.	920 398
Dimensions (W x H)	13 x 7 mm

EMC Spring Terminals

Two spring terminals for the protected and unprotected side of a BLITZDUCTOR BSP/XT/XTU arrester for permanent low-impedance shield contact with a shielded signal line. Insulating cap for indirect shield earthing (BXT only), cable ties and insulating strips included. Suitable for BXT(U) ML2 ...S ... / BSP M2 ... types (direct shield earthing only).



Type	SAK BXT LR
Part No.	920 395
D1 Lightning impulse current (10/350 μs)	5 kA
Plugs into	terminal BXT BAS / BSP BAS 4
Accessories	insulating caps, cable ties, insulating strips

Accessories for BLITZDUCTOR XT/XTU

DRC MCM XT

DIN rail mounted device with integrated RFID LifeCheck sensor for condition monitoring of max. 10 BXT/BXTU arresters with RFID LifeCheck. An RS 485 interface allows the interconnection of up to 15 DRC MCM XT.

Type	DRC MCM XT
Part No.	910 695
Colour	grey



DRC SCM XT

DIN rail mounted device with integrated RFID LifeCheck sensor for condition monitoring of max. 10 BXT/BXTU arresters with RFID LifeCheck.

Type	DRC SCM XT
Part No.	910 696
Colour	grey

DRC LC M3+

Portable device with RFID LifeCheck sensor for flexible use. Fast and easy testing of arresters with RFID LifeCheck. Documentation via PC database.

Type	DRC LC M3+
Part No.	910 653
Dimensions of storage case	340 x 275 x 83 mm



DRC LC M1+

Portable device with RFID LifeCheck sensor for flexible use. Fast and easy testing of arresters with RFID LifeCheck.

Type	DRC LC M1+
Part No.	910 655
Dimensions of storage case	275 x 230 x 83 mm



RFID LifeCheck Sensor for DRC BXT

Snap-on RFID LifeCheck sensor and test module for use as spare part / extension for portable RFID LifeCheck test devices.

Type	LCS DRC BXT
Part No.	910 652
For testing	BLITZDUCTOR XT ML



DIN Rail Mounted Power Supply Unit

High-performance DIN rail mounted power supply unit with single-phase wide-range input can be connected to different supply systems. The operating state indicator on the front panel indicates whether the output voltage is present. Supply of stationary condition monitoring devices of the DEHNrecord portfolio (DRC SCM XT / DRC MCM XT / DRC IRCM).

Type	PSU DC24 30W
Part No.	910 499
Input voltage range	AC 85-264 V; DC 120-373 V
Frequency	44-66 Hz; 0 Hz
Input current (I _a)	0.7 A at AC 110 V / 0.5 A at AC 230 V
Output nominal voltage (U _a)	DC 24 V (SELV)
Output current (I _a)	1.3 A at DC 24 V, max. 0.9 A at any installation position
Recommended backup fuse	circuit breaker 10 A, 16 A, characteristic B, C
Standards / regulations	EN 60950, EN 61204-3, UL 60950, UL 508, GL



USB Interface Converter USB NANO 485





USB NANO 485 converts between USB and RS485 signals and is specifically designed for two-wire RS-485 buses. LEDs indicate the operating state (yellow), Rx (green) and Tx (red). Due to its compact dimensions, USB NANO 485 is ideally suited for use with notebooks, however, stationary use is also possible.

Type	USB NANO 485
Part No.	910 486
Version	with LED indication



Pluggable SPDs –
DIN Rail Mounted







List of Approvals – BLITZDUCTORconnect – Modular (as of October 2019)

Part No.	Type	ATEX 	IECEX 	CSA-Hazloc 	SIL (up to SIL3)	UL 
927 210	BCO ML2 B 180	(●)	(●)		●	●
927 222	BCO ML2 BE 12	(●)	(●)		●	●
927 224	BCO ML2 BE 24	(●)	(●)		●	●
927 225	BCO ML2 BE 48	(●)	(●)		●	●
927 242	BCO ML2 BD 12	(●)	(●)		●	●
927 244	BCO ML2 BD 24	(●)	(●)		●	●
927 245	BCO ML2 BD 48	(●)	(●)		●	●
927 270	BCO ML2 BE HF 5	(●)	(●)		●	●
927 271	BCO ML2 BD HF 5	(●)	(●)		●	●
927 284	BCO ML2 BD EX 24	●(13a)	●(14a)		●	●

(1a)	DEKRA 11ATEX0089 X: II 3 G Ex nA IIC T4 Gc
(2a)	DEK 11.0032X: Ex nA IIC T4 Gc
(3a)	KEMA 06ATEX0274 X: II 2(1) G Ex ia [ia Ga] IIC T4...T6 Gb KEMA 06ATEX0274 X: II 2 G Ex ib IIC T4...T6 Gb
(4a)	DEK 11.0078 X: Ex ia [ia Ga] IIC T4...T6 Gb DEK 11.0078 X: Ex ib IIC T4, T5, T6 Gb
(5a)	CSA 2516389: Class I Div. 2 GP A, B, C, D T4 CSA 2516389: Class I Zone 2, AEx nA IIC T4
(6a)	CSA 70000011: IS, Class I, Zone 1, AEx ia [ia] IIC T4...T6 CSA 70000011: IS, Class I, Div 1, Group A, B, C, D, T4...T6 CSA 70000011: Ex ia [ia] IIC T4...T6 Gb
(7a)	CSA 2392869: IS, Class I, Div. 1, GP A, B, C, D T4...T6 CSA 2392869: IS, Class I, Zone 1, AEx ia IIC T4...T6 CSA 2392869: Ex ia IIC T4...T6 CSA 2392869: Class I Div. 2, GP A,B,C,D T4...T6 CSA 2392869: Class I, Zone 2, AEx nA IIC T4...T6 CSA 2392869: Ex nA IIC T4...T6







(8a)	KEM 09.0077X: Ex ia [ia Ga] IIC T4...T6 Gb KEM 09.0077X: Ex ic IIC T4...T6 Gc KEM 09.0077X: Ex nA IIC T4...T6 Gc
(9a)	KEMA 09ATEX0177 X: II 3 G Ex ic IIC T4 ... T6 Gc KEMA 09ATEX0177 X: II 3 G Ex nA IIC T4 ... T6 Gc KEMA 09ATEX0178 X: II 2(1) G Ex ia [ia Ga] IIC T4...T6 Gb
(10a)	EAC TC RU C-DE.GB06.B00505 0ExIIICT4/T5/T6
(11a)	EAC TC RU C-DE.GB06.B00505 1ExIIICT4/T5/T6
(12a)	TÜV 17 0697 X Ex ia [ia Ga] IIC T6...T4 Gb TÜV 17 0697 X Ex ib IIC T6...T4 Gb
(13a)	TÜV 19 ATEX 8476 X: II (1)2 G Ex ia [ia Ga] IIC T6 Gb TÜV 19 ATEX 8476 X: II 2 G Ex ib IIC T6 Gb TÜV 19 ATEX 8476 X: II (1) D [Ex ia Da] IIIC
(14a)	IECEX TUR 20.0025X: Ex ia [ia Ga] IIC T6 Gb IECEX TUR 20.0025X: Ex ib IIC T6 Gb IECEX TUR 20.0025X: [Ex ia Da] IIIC
(●)	Approval pending

List of Approvals – BLITZDUCTOR XT/XTU (as of October 2019)

Part No.	Type	ATEX 	IECEX 	CSA-Hazloc 	SIL (up to SIL3)	UL 	CSA 	EAC 	EAC 	INMETRO
920 211	BXT ML2 B 180	●(1a)	●(2a)	●(5a)	●		●	●		
920 220	BXT ML2 BE S 5	●(1a)	●(2a)	●(5a)	●		●	●		
920 222	BXT ML2 BE S 12	●(1a)	●(2a)	●(5a)	●		●	●		
920 224	BXT ML2 BE S 24	●(1a)	●(2a)	●(5a)	●		●	●		
920 225	BXT ML2 BE S 48	●(1a)	●(2a)	●(5a)	●	●	●	●		
920 226	BXT ML2 BE S 36					●		●		
920 240	BXT ML2 BD S 5	●(1a)	●(2a)	●(5a)	●		●	●		
920 242	BXT ML2 BD S 12	●(1a)	●(2a)	●(5a)	●		●	●		
920 243	BXT ML2 BD DL S 15	●(1a)	●(2a)	●(5a)	●			●		
920 244	BXT ML2 BD S 24	●(1a)	●(2a)	●(5a)	●		●	●		
920 245	BXT ML2 BD S 48	●(1a)	●(2a)	●(5a)	●		●	●		
920 247	BXT ML2 BD 180	●(1a)	●(2a)	●(5a)	●		●	●		
920 270	BXT ML2 BE HFS 5	●(1a)	●(2a)	●(5a)	●	●	●	●		
920 271	BXT ML2 BD HFS 5	●(1a)	●(2a)	●(5a)	●	●	●	●		
920 280	BXT ML2 BD S EX 24	●(3a)	●(4a)	●(6a)	●				●(11a)	●(12a)
920 288	BXT ML2 MY E 110							●		
920 289	BXT ML2 MY 250							●		
920 296	BXT ML BD HC5A 24				●			●		
920 308	BXT M4 E							●		
920 309	BXT M4 E							●		
920 310	BXT ML4 B 180	●(1a)	●(2a)	●(5a)	●		●	●		
920 314	BXT ML4 BPD 24				●			●		
920 320	BXT ML4 BE 5	●(1a)	●(2a)	●(5a)	●	●	●	●		
920 322	BXT ML4 BE 12	●(1a)	●(2a)	●(5a)	●	●	●	●		
920 324	BXT ML4 BE 24	●(1a)	●(2a)	●(5a)	●	●	●	●		
920 325	BXT ML4 BE 48	●(1a)	●(2a)	●(5a)	●	●	●	●		
920 326	BXT ML4 BE 60	●(1a)	●(2a)	●(5a)	●	●	●	●		
920 327	BXT ML4 BE 180	●(1a)	●(2a)	●(5a)	●	●	●	●		
920 336	BXT ML4 BE 36	●(1a)	●(2a)	●(5a)	●	●		●		
920 340	BXT ML4 BD 5	●(1a)	●(2a)	●(5a)	●	●	●	●		
920 342	BXT ML4 BD 12	●(1a)	●(2a)	●(5a)	●	●	●	●		
920 344	BXT ML4 BD 24	●(1a)	●(2a)	●(5a)	●	●	●	●		
920 345	BXT ML4 BD 48	●(1a)	●(2a)	●(5a)	●	●	●	●		
920 346	BXT ML4 BD 60	●(1a)	●(2a)	●(5a)	●	●	●	●		
920 347	BXT ML4 BD 180	●(1a)	●(2a)	●(5a)	●	●	●	●		
920 350	BXT ML4 BC 5	●(1a)	●(2a)	●(5a)	●		●	●		
920 354	BXT ML4 BC 24	●(1a)	●(2a)	●(5a)	●		●	●		
920 362	BXT ML4 BE C 12	●(1a)	●(2a)	●(5a)	●			●		
920 364	BXT ML4 BE C 24	●(1a)	●(2a)	●(5a)	●		●	●		
920 370	BXT ML4 BE HF 5	●(1a)	●(2a)	●(5a)	●	●	●	●		
920 371	BXT ML4 BD HF 5	●(1a)	●(2a)	●(5a)	●	●	●	●		
920 375	BXT ML4 BD HF 24	●(1a)	●(2a)	●(5a)	●	●	●	●		
920 381	BXT ML4 BD EX 24	●(3a)	●(4a)	●(6a)	●		●		●(10a)	●(12a)
920 383	BXT M2 BD S EX 24	●(9a)	●(8)	●(7a)	●					
920 384	BXT ML4 BC EX 24	●(3a)	●(4a)	●(6a)	●				●(10a)	●(12a)
920 388	BXT ML4 MY 110							●		
920 389	BXT ML4 MY 250				●			●		
920 538	BXT ML2 BD HF EX 6	●(3a)	●(4a)	●(6a)	●				●(11a)	●(12a)
920 249	BXTU ML2 BD S 0-180				●	●	●	●		
920 349	BXTU ML4 BD 0-180				●	●	●	●		



















Pluggable SPDs – DIN Rail Mounted

List of Approvals – BLITZDUCTOR SP (as of October 2019)

Part No.	Type	ATEX 	IECEX 	CSA-Hazloc 	SIL (up to SIL3)	UL 	CSA 	EAC 
926 220	BSP M2 BE 5				•	•	•	•
926 222	BSP M2 BE 12				•	•	•	•
926 224	BSP M2 BE 24				•	•	•	•
926 225	BSP M2 BE 48				•	•	•	•
926 226	BSP M2 BE 60				•	•	•	•
926 227	BSP M2 BE 180				•	•	•	•
926 240	BSP M2 BD 5				•	•	•	•
926 242	BSP M2 BD 12				•	•	•	•
926 244	BSP M2 BD 24				•	•	•	•
926 245	BSP M2 BD 48				•	•	•	•
926 246	BSP M2 BD 60				•	•	•	•
926 247	BSP M2 BD 180				•	•	•	•
926 270	BSP M2 BE HF 5				•	•	•	•
926 271	BSP M2 BD HF 5				•	•	•	•
926 275	BSP M2 BD HF 24					•	•	•
926 320	BSP M4 BE 5				•	•	•	•
926 322	BSP M4 BE 12				•	•	•	•
926 324	BSP M4 BE 24				•	•	•	•
926 325	BSP M4 BE 48				•	•	•	•
926 326	BSP M4 BE 60				•	•	•	•
926 327	BSP M4 BE 180				•	•	•	•
926 340	BSP M4 BD 5				•	•	•	•
926 342	BSP M4 BD 12				•	•	•	•
926 344	BSP M4 BD 24				•	•	•	•
926 345	BSP M4 BD 48				•	•	•	•
926 346	BSP M4 BD 60				•	•	•	•
926 347	BSP M4 BD 180				•	•	•	•
926 370	BSP M4 BE HF 5				•	•	•	•
926 371	BSP M4 BD HF 5				•	•	•	•
926 375	BSP M4 BD HF 24					•	•	•

Pluggable SPDs –
DIN Rail Mounted

Compact SPDs – DIN Rail Mounted

Basic circuit diagram / Symbol	Type	Product	Part No.	Page
BLITZDUCTORconnect – Compact				
	BCO CL2 ... – Combined lightning current and surge arrester in a compact enclosure – With push-in connection technology – Integrated LifeCheck and visual status indication		927 9XX	183
	BCO CL2 BD EX 24 – Surge arrester in a compact enclosure for hazardous areas – With push-in connection technology – Integrated LifeCheck and visual status indication		927 984	184
DEHNconnect SD2				
	DCO SD2 ... – DIN rail mounted surge arrester – With push-in connection technology – Disconnection function for the signal circuit		 917 XXX	186
	DCO SD2 MD EX – DIN rail mounted surge arrester for hazardous areas – With push-in connection technology – Disconnection function for the signal circuit		 917 960	187
DEHNvario				
	DVR 2 BY S 150 FM – Combined lightning current and surge arrester in a compact enclosure – For voice alarm and loudspeaker applications – With remote signalling contact		928 430	190
	DVR BNC RS485 230 – 3-in-1 surge arrester in a compact enclosure – Protects 230V / RS485 / coaxial signal interfaces – With push-in connection technology		928 440	190
BLITZDUCTOR VT				
	BVT ... – Lightning current and surge arrester in a compact enclosure – Wide range of solutions for d.c. supply systems and data interfaces – With screw terminals		918 401 918 422 918 408 918 409 918 411	192 192 192 192 192
	BVT KKS ... – Combined lightning current and surge arrester in a compact enclosure – Solutions for cathodic protection applications – With screw terminals		918 420 918 421	193 193



BLITZDUCTORconnect – Compact



BLITZDUCTORconnect for protecting measuring and control systems

NEW

The combined lightning current and surge arresters of the BLITZDUCTORconnect series with a compact design are designed for universal use and system protection in industrial environments, at information technology signal interfaces, and in the field of automation or measuring and control technology:

Thanks to their high lightning current discharge capacity and low voltage protection levels, they optimally meet the requirements for reliably protecting terminal equipment.

The arresters are available in different types and protect two single lines sharing a common reference potential (unbalanced interfaces) or one un-earthed pair (balanced interface). An arrester with a high cut-off frequency is available for balanced bus interfaces with high data rates (e.g.: Profibus, RS485), an Ex approved type (dust and gas) for intrinsically safe signal circuits.

The cables are connected using the vibration-proof push-in connection technology. For connection, stripped solid and flexible conductors with wire end ferrules can be clamped and contacted quickly, easily and without tools. When rewiring, the conductor is freed from the clamping point by pressing the release button and reconnected into the appropriate terminal. Holes in the housing at each conductor terminal allow measurements in the signal circuit using test probes.



Quickly tested – at a glance
Integrated indication for easy and fast maintenance



Connect = Protect
Push-in connection technology for simple and fast cable connection



Easy maintenance
Simple status message with monitoring unit for arrester groups



Maximum system availability
Approvals for use in intrinsically safe measuring circuits

- **Universal lightning current and surge arrester**
 - For protecting data bus interfaces as well as measuring and control circuits
 - High discharge capacity of 3 kA (10/350 μ s), 10 kA (8/20 μ s)
 - Max. impulse current carrying capability (8/20 μ s) I_{max} up to 20 kA
 - Low voltage protection level, also capable of protecting terminal equipment
- **Compact arrester**
 - Fast and simple cable connection thanks to push-in connection technology
 - High system availability thanks to fail-safe performance
- **Function-optimised design with a width of 6 mm**
 - LifeCheck and visual status indication integrated in the module
 - Simple remote signalling of the status with the help of an optional remote signalling unit
 - Vibration and shock-tested for safe operation

The arresters of the BLITZDUCTORconnect series are equipped with a mechanical status indication which clearly shows the status of the arrester (green or red indicator flag). In the event of arrester overload, the arrester of an arrester group to be replaced is identified visually (red indicator flag).

Optionally, arrester groups can be monitored using a built-in remote signalling unit. The status is reported to a higher-level control system via a floating break contact.

The combination of transmitter and receiver unit in a single device minimises the wiring effort when installing the remote signalling unit. At the same time, there is no need for additional parameterisation of the modules.

A defined fail-safe function (fail-open) disconnects the overloaded components (decoupling impedance, fine protection) from the signal circuit. However, the signal circuit itself remains active and is not interrupted. The system circuit remains available and operation is maintained until the arrester is replaced. In this way, plants and systems can be operated safely and are highly available at all times.

Arresters with approval for Ex applications and other accessories, e.g. PARTITION EX1 for disconnecting intrinsically safe and non-intrinsically safe signal circuits, round off the product portfolio.

BCO CL2 B 180

Space-saving, compact lightning current arrester with a width of 6 mm and push-in connection technology with status indication for protecting two single lines for lightning equipotential bonding as well as indirect earthing of shielded cables.

Type BCO CL2 ...	B 180
Part No.	927 910 <small>NEW</small>
SPD class	TYPE 1
Max. continuous operating voltage (d.c.) (U_c)	180 V
Nominal current (I_L)	1.2 A
D1 Lightning impulse current (10/350 μ s) per line (I_{imp})	1.5 kA
C2 Total nominal discharge current (8/20 μ s) (I_n)	10 kA
Series resistance per line	0 ohms
Approvals	UL, SIL

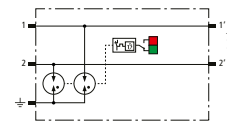

BCO CL2 BE

Space-saving, compact combined arrester with a width of 6 mm and push-in connection technology with status indication for protecting two single lines sharing a common reference potential as well as unbalanced interfaces.

Type BCO CL2 ...	BE 12	BE 24	BE 48
Part No.	927 922 <small>NEW</small>	927 924 <small>NEW</small>	927 925 <small>NEW</small>
SPD class	TYPE 1P1	TYPE 1P1	TYPE 1P1
Max. continuous operating voltage (d.c.) (U_c)	15 V	33 V	54 V
Nominal current at 70 °C (I_L)	0.75 A	0.75 A	0.75 A
D1 Lightning impulse current (10/350 μ s) per line (I_{imp})	1.5 kA	1.5 kA	1.5 kA
C2 Total nominal discharge current (8/20 μ s) (I_n)	10 kA	10 kA	10 kA
Series resistance per line	1 ohms	1 ohms	1 ohms
Cut-off frequency line-line (f_c)	1.4 MHz	3.4 MHz	5 MHz
Approvals	UL, SIL	UL, SIL	UL, SIL

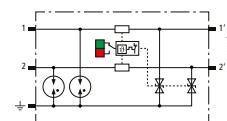

BCO CL2 BD

Space-saving, compact combined arrester with a width of 6 mm and push-in connection technology with status indication for protecting one pair of unearthed balanced interfaces.

Type BCO CL2 ...	BD 12	BD 24	BD 48
Part No.	927 942 <small>NEW</small>	927 944 <small>NEW</small>	927 945 <small>NEW</small>
SPD class	TYPE 1P2	TYPE 1P2	TYPE 1P2
Max. continuous operating voltage (d.c.) (U_c)	15 V	36 V	56 V
Nominal current at 70 °C (I_L)	0.75 A	0.75 A	0.75 A
D1 Lightning impulse current (10/350 μ s) per line (I_{imp})	1.5 kA	1.5 kA	1.5 kA
C2 Total nominal discharge current (8/20 μ s) (I_n)	10 kA	10 kA	10 kA
Series resistance per line	1 ohms	1 ohms	1 ohms
Cut-off frequency line-line (f_c)	2.6 MHz	5.8 MHz	7.2 MHz
Approvals	UL, SIL	UL, SIL	UL, SIL

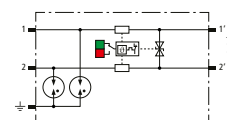

BCO CL2 BE HF

Space-saving, compact combined arrester with a width of 6 mm and push-in connection technology with status indication for protecting two single lines of high-frequency transmissions sharing a common reference potential as well as unbalanced interfaces.

Type BCO CL2 ...	BE HF 5
Part No.	927 970 <small>NEW</small>
SPD class	TYPE 1P1
Max. continuous operating voltage (d.c.) (U_c)	8.5 V
Nominal current at 70 °C (I_L)	0.75 A
D1 Lightning impulse current (10/350 μ s) per line (I_{imp})	1.5 kA
C2 Total nominal discharge current (8/20 μ s) (I_n)	10 kA
Series resistance per line	1 ohms
Approvals	UL, SIL

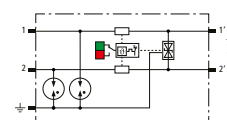

BCO CL2 BD HF

Space-saving, compact combined arrester with a width of 6 mm and push-in connection technology with status indication for protecting one pair of unearthed high-frequency bus systems as well as balanced interfaces.

Type BCO CL2 ...	BD HF 5
Part No.	927 971 <small>NEW</small>
SPD class	TYPE 1P2
Max. continuous operating voltage (d.c.) (U_c)	8.5 V
Nominal current at 70 °C (I_L)	0.75 A
D1 Lightning impulse current (10/350 μ s) per line (I_{imp})	1.5 kA
C2 Total nominal discharge current (8/20 μ s) (I_n)	10 kA
Series resistance per line	1 ohms
Cut-off frequency line-line (f_c)	100 MHz
Approvals	UL, SIL

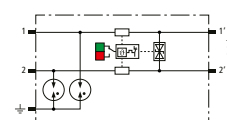

NEW

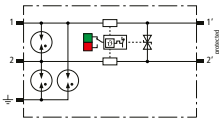

BCO CL2 BD EX 24

Space-saving, compact surge arrester with a width of 6 mm and push-in connection technology with status indication for protecting one pair of intrinsically safe measuring circuits and bus systems, meets FISCO requirements. Insulation strength > 500 V line-ground.

Type BCO CL2 ...	BD EX 24
Part No.	927 984 <small>NEW</small>
SPD class	TYPE 1P2
Max. continuous operating voltage (d.c.) (U _c)	36 V
D1 Lightning impulse current (10/350 μs) per line (I _{imp})	1.5 kA
C2 Total nominal discharge current (8/20 μs) (I _n)	10 kA
Series resistance per line	1 ohms
Cut-off frequency line-line (f _c)	3.5 MHz
Approvals	SIL, ATEX, IECEx

Accessories for BLITZDUCTORconnect – Compact

DIN Rail Mounted Power Supply Unit

High-performance DIN rail mounted power supply unit with single-phase wide-range input can be connected to different supply systems. The operating state indicator on the front panel indicates whether the output voltage is present. Supply of stationary condition monitoring devices of the DEHNrecord portfolio (DRC SCM XT / DRC MCM XT / DRC IRCM).



Type	PSU DC24 30W
Part No.	910 499
Input voltage range	AC 85-264 V; DC 120-373 V
Frequency	44-66 Hz; 0 Hz
Input current (I _e)	0.7 A at AC 110 V / 0.5 A at AC 230 V
Output nominal voltage (U _a)	DC 24 V (SELV)
Output current (I _a)	1.3 A at DC 24 V, max. 0.9 A at any installation position
Recommended backup fuse	circuit breaker 10 A, 16 A, characteristic B, C
Standards / regulations	EN 60950, EN 61204-3, UL 60950, UL 508, GL

PARTITION EXI

Special installation conditions must be considered when installing BLITZDUCTORconnect surge protective devices in intrinsically safe circuits. In accordance with EN 60079-11;2007 a minimum distance (thread measure) of ≥ 50 mm must be maintained between intrinsically and non-intrinsically safe circuits (connecting parts, e.g. terminals)! When using the Ex i partition of type PARTITION EXI, this distance is also maintained if the surge protective devices are arranged directly next to one other. Ideally suited for use in conjunction with DRC IRCM for condition monitoring of BCO modules (1 set = 2 pieces).

NEW



Type	PARTITION EXI
Part No.	910 797 <small>NEW</small>
Colour	blue
For mounting on	35 mm DIN rails acc. to EN 60715

DRC IRCM

DEHNrecord condition monitoring unit, DIN rail mounted set with integrated visual transmitter/receiver as well as visual reverse unit for monitoring the condition of BLITZDUCTORconnect arresters with LifeCheck. Visual status indication via LED group display combined with remote signalling (break contact).

NEW



Type	DRC IRCM
Part No.	910 710 <small>NEW</small>
Input voltage range (d.c.) (U _N)	6-35 V DC
Max. rated current consumption (I _N)	≤ 10 mA
Operating temperature range (T _U)	-30 °C ... +70 °C
Approvals	UL, ATEX, IECEx



DEHNconnect SD2

- Terminal block with integrated surge protection
 - For protecting measuring and control circuits and bus systems
 - Maximum impulse current carrying capability I_{max} up to 20 kA (8/20 μ s)
 - Low voltage protection level, capable of protecting terminal equipment
- Modular disconnection function
 - Disconnection module for disconnecting the signal circuit for maintenance work
 - Module fixing and mechanical ejector
 - Module in "parked" position after disconnection
- Space-saving and function-optimised design
 - Terminal block with integrated surge protection (width of 6 mm)
 - Fast conductor connection without tools thanks to direct plug-in technology
 - Can be used with jumper bar (accessory)



Application example: DEHNconnect for protecting the I/O of PLC interfaces.

The surge arresters of the DEHNconnect SD2 series are designed as space-saving terminal blocks with a width of 6 mm. These terminal blocks with integrated surge protection have a modular disconnection function that allows them to interrupt the signal circuit for maintenance work. An integrated module ejector disconnects the signal circuit from the terminal equipment. The disconnection module does not have to be removed, but remains in a "parked" position in the module slot.

Different types of arrester are available to protect two single lines sharing a common reference potential (unbalanced interfaces) or an unearthed pair (balanced interface). Arresters with a high cut-off frequency (HF) can be used for balanced bus interfaces with high data rates (e.g. Profibus, RS485).

Conductors are connected via a vibration-proof spring-loaded connection system. Stripped solid conductors and flexible conductors with wire end ferrule can be easily and quickly inserted into the relevant conductor terminal without tools. For rewiring, the conductor is removed from the clamping point and clamped into a new conductor terminal.

To reduce wiring, jumper bars can be inserted on the protected side of the surge arrester, thus quickly connecting signal circuits.

The arresters are ideally suited for use in industrial environments at information technology signal interfaces of automation, measuring and control as well as bus systems.



Disconnection module with ejector – for disconnecting the signal circuits.



Marking of the protected side – minimises wiring errors.



Terminals with direct-plug-in technology – fast and vibration-proof connection.



Slots for jumper bars – for quickly connecting signal circuits.

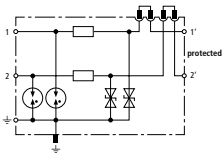

DCO SD2 ME

Energy-coordinated surge arrester with disconnection function for protecting two single lines sharing a common reference potential as well as unbalanced interfaces.

Type DCO SD2 ...	ME 12	ME 24	ME 48
Part No.	917 920	917 921	917 922
SPD class	TYPE 2 P1	TYPE 2 P1	TYPE 2 P1
Max. continuous operating voltage (d.c.) (U _c)	14 V	33 V	55 V
Nominal current at 80 °C (I _n)	0.5 A	0.5 A	0.5 A
D1 Lightning impulse current (10/350 µs) per line (I _{imp})	1 kA	1 kA	1 kA
C2 Total nominal discharge current (8/20 µs) (I _n)	10 kA	10 kA	10 kA
Cut-off frequency line-PG (f _c)	2.5 MHz	6 MHz	7.5 MHz
Approvals	UL, CSA, SIL, EAC, ATEX, IECEx	UL, CSA, SIL, EAC, ATEX, IECEx	UL, CSA, SIL, EAC, ATEX, IECEx

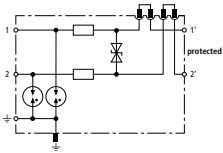

DCO SD2 MD

Energy-coordinated surge arrester with disconnection function for protecting one unearthed pair as well as balanced interfaces.

Type DCO SD2 ...	MD 12	MD 24	MD 48
Part No.	917 940	917 941	917 942
SPD class	TYPE 2 P1	TYPE 2 P1	TYPE 2 P1
Max. continuous operating voltage (d.c.) (U _c)	14 V	33 V	55 V
Nominal current at 80 °C (I _n)	0.5 A	0.5 A	0.5 A
D1 Lightning impulse current (10/350 µs) per line (I _{imp})	1 kA	1 kA	1 kA
C2 Total nominal discharge current (8/20 µs) (I _n)	10 kA	10 kA	10 kA
Cut-off frequency line-PG (f _c)	2.5 MHz	6 MHz	8 MHz
Approvals	UL, CSA, SIL, EAC, ATEX, IECEx	UL, CSA, SIL, EAC, ATEX, IECEx	UL, CSA, SIL, EAC, ATEX, IECEx

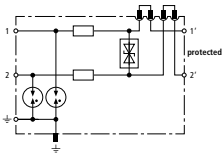

DCO SD2 MD HF

Energy-coordinated surge arrester with disconnection function for protecting balanced interfaces with extra-low voltages. Also suitable for high transmission rates.

Type DCO SD2 ...	MD HF 5
Part No.	917 970
SPD class	TYPE 2 P1
Max. continuous operating voltage (d.c.) (U _c)	8.5 V
Nominal current at 80 °C (I _n)	0.5 A
D1 Lightning impulse current (10/350 µs) per line (I _{imp})	1 kA
C2 Total nominal discharge current (8/20 µs) (I _n)	10 kA
Cut-off frequency line-line (f _c)	100 MHz
Approvals	UL, CSA, SIL, EAC, ATEX, IECEx

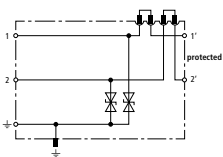

DCO SD2 E

Finely-limiting surge protective device with disconnection function for two single lines sharing a common reference potential and unbalanced interfaces.

Type DCO SD2 ...	E 12	E 24	E 48
Part No.	917 987	917 988	917 989
SPD class	TYPE 3 P1	TYPE 3 P1	TYPE 4 P1
Max. continuous operating voltage (d.c.) (U _c)	13 V	28 V	58 V
Nominal current at 60 °C (I _n)	10 A	10 A	10 A
C1 Total nominal discharge current (8/20 µs) (I _n)	0.8 kA	0.6 kA	0.3 kA
Cut-off frequency line-PG (f _c)	2.3 MHz	5.5 MHz	8.7 MHz
Approvals	UL, CSA, SIL, EAC	UL, CSA, SIL, EAC	UL, CSA, SIL, EAC



DEHNconnect SD2 Ex (i)

- Terminal block with integrated surge protection
 - For protecting intrinsically safe measuring and control circuits and bus systems (Ex (i))
 - Maximum impulse current carrying capability I_{max} up to 20 kA (8/20 μ s)
 - Low voltage protection level, capable of protecting terminal equipment
 - Approvals: ATEX, IECEx
- Modular disconnection function
 - Disconnection module for disconnecting the signal circuit for maintenance work
 - Module fixing and mechanical ejector
 - Module in "parked" position after disconnection
- Space-saving and function-optimised design
 - Terminal block with integrated surge protection (width of 6 mm)
 - Fast conductor connection without tools thanks to direct plug-in technology
 - Can be used with jumper bar (accessory)



Arrester group for protecting intrinsically safe measuring circuits

Compact SPDs –
DIN Rail Mounted

The DIN rail mounted surge arresters of the DEHNconnect SD2 series are designed as space-saving terminal blocks with a width of 6 mm. These terminal blocks with integrated surge protection have a modular disconnection function that allows them to disconnect the signal circuit for maintenance work. An integrated module ejector disconnects the signal circuit from the terminal equipment. The disconnection module does not have to be removed, but remains in a "parked" position in the module slot.

DEHNconnect SD2 Ex (i) is designed for intrinsically safe measuring and control circuits and bus systems and protects one unearthed pair (balanced interface).

Conductors are connected via a vibration-proof spring-loaded connection system. Stripped solid conductors and flexible conductors with wire end ferrule can be easily and quickly inserted into the relevant conductor terminal without tools. For rewiring, the conductor is removed from the clamping point and clamped into a new conductor terminal.

To reduce wiring, jumper bars can be inserted on the protected side of the surge arrester, thus quickly connecting signal circuits.

The arresters are ideally suited for use in the process industry to protect Ex (i) measuring circuits and interfaces for bus communication (e.g. Fieldbus Foundation or Profibus PA).



Disconnection module with ejector – for disconnecting the signal circuits.



Marking of the protected side – minimises wiring errors.



Terminals with direct plug-in technology – fast and vibration-proof connection without tools.



Slots for jumper bars – for quickly connecting signal circuits.

DCO SD2 MD EX

Surge arrester with energy-coordinated low-capacitance protective circuit and disconnection module for disconnecting signal circuits. For protecting one pair in intrinsically safe measuring circuits and bus systems, meets FISCO requirements. Self-capacitance and self-inductance negligibly small. Insulation strength > 500 V to earth.

Type	DCO SD2 MD EX 24
Part No.	917 960
SPD class	TYPE 2 PI
Max. continuous operating voltage (d.c.) (U_c)	33 V
Max. input current according to EN 60079-11 (I_i)	0.5 A
D1 Lightning impulse current (10/350 μ s) per line (I_{imp})	1 kA
C2 Total nominal discharge current (8/20 μ s) (I_n)	10 kA
Cut-off frequency line-line (f_c)	5.8 MHz
Approvals	UL, CSA, EACEx, ATEX, IECEx, SIL

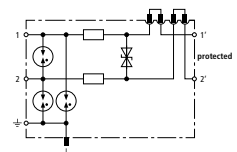

Accessories for DEHNconnect SD2



Signal Disconnect Disconnection Module (Spare Part)

Disconnection module (spare part) to be plugged into DCO SD2 for disconnecting the signal in the system circuit.

Type	DCO SD2
Part No.	917 900
Width	6 mm

Jumper Bar

Multipole jumper bar for DCO SD2 terminal blocks with integrated surge protection.



Type	KB 10 DCO RK
Part No.	919 880
Poles	10



Quick Labelling System, horizontal imprint

Plate with 2x plate numbers from 1 to 50 for DCO SD2, horizontal imprint.

Type	LS 1 50 H DCO
Part No.	917 977
Material	plastic



DEHNvario

- **Variable arrester series**
 - Compact terminals ensure easy and fast installation
 - Direct plug-in technology allows connection without tools
 - Fast arrester replacement by simply releasing and removing the terminal unit
 - Earthing / equipotential bonding via DIN rail
 - Customised and application-specific surge protection

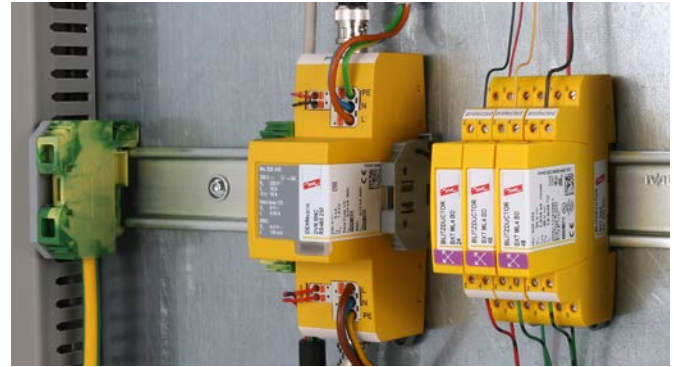

Space-saving and application-optimised 3-in-1 DEHNvario arrester for analogue camera systems.

DEHNvario product line – Surge or combined arresters in a compact DIN rail mounted enclosure.

Innovative enclosure concept

The innovative enclosure design provides maximum functionality in a minimum amount of space. In addition to the standard catalogue products, the enclosure concept offers flexibility in terms of space and different connection systems to **implement customised and application-specific solutions** (upon request). Supplemented by solution-oriented surge protection, the integrated customer function can be protected from possible interference resulting from lightning strikes and surges.

Terminals with direct plug-in technology

The different types feature terminals for conductor connection with direct plug-in technology. This allows easy connection of conductors without tools. The spring-loaded terminals apply a defined pressure on the conductors which automatically equalises any deformation of

connected conductors and prevents self-loosening of the wires. The plugged-in conductors can be easily released at the push of a button and individually removed from the relevant terminal.

The terminal unit is snapped into the enclosure and is thus vibration-proof in all environmental conditions. Easy and fast arrester replacement is ensured by removing the terminal units from the enclosure using an unlocking tool or screw driver. Thus there is no need to disconnect the cores individually. Thanks to the integrated test openings in the terminal units, the signal circuit can be tested efficiently even when wired. The signal lines can be contacted by means of a test pin (max. diameter of 1 mm) (device must be installed).

Safe and easy earthing

The lightning and impulse current carrying earth contact allows the arresters to be easily connected to the equipotential bonding via the DIN rail without requiring an equipotential bonding conductor.



Direct plug-in technology ensures easy conductor connection without tools.



Fast arrester replacement by simply removing the terminal unit.



Integrated test ports for testing the signal circuit by means of test pins.



Lightning and impulse current carrying earth contact.



Optional integrated indication.



Sample solution: Compact 3-in-1 arrester for protecting 3 interfaces in a single device.

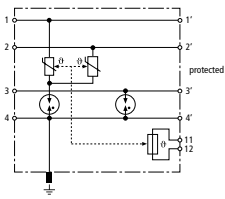

DVR 2 BY S 150 FM

Compact combined arrester for protecting electroacoustic systems (e.g. voice alarm systems, loudspeaker systems). Protection of one galvanically isolated pair; direct or indirect shield earthing. Direct plug-in technology allows fast conductor connection without tools. Easy replacement of the arrester is ensured by the integrated terminal units which can be released and then removed from the enclosure. Integrated remote signalling contact (break contact).

Type DVR ...	2 BY S 150 FM
Part No.	928 430
SPD class	TYPE 1P2
Max. continuous operating voltage (d.c.) (U_c)	150 V
Nominal current at 70 °C (I_L)	10 A
Nominal current at 80 °C (I_L)	7 A
D1 Lightning impulse current (10/350 μ s) per line (I_{imp})	2.5 kA
C2 Total nominal discharge current (8/20 μ s) (I_n)	22.5 kA
Cut-off frequency line-line (f_G)	1.4 MHz
Approvals	EAC

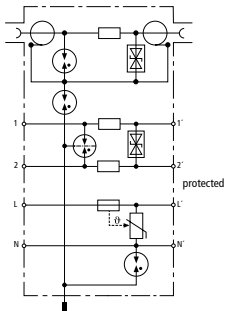

DVR BNC RS485 230

Compact 3-in-1 surge arrester for protecting analogue camera systems. Protection of the video signal (BNC connection), a data signal (RS485) and a voltage supply (230 V a.c.). Direct plug-in technology allows fast conductor connection without tools. Easy replacement of the arrester is ensured by the integrated terminal units which can be released and then removed from the enclosure. Integrated overload indication (230 V).

Type DVR ...	BNC RS485 230
Part No.	928 440
Video (BNC)	
SPD class	TYPE 2P2
Max. continuous operating voltage (d.c.) (U_c)	6.4 V
Nominal current (I_L)	0.1 A
C2 Nominal discharge current (8/20 μ s) shield-PG (I_n)	10 kA
Insertion loss at 300 MHz (75 ohms)	≤ 3.0 dB
Connection (input / output)	BNC socket / BNC socket
Daten (RS485)	
SPD class	TYPE 2P1
Max. continuous operating voltage (d.c.) (U_c)	8 V
Nominal current (I_L)	0.5 A
C2 Total nominal discharge current (8/20 μ s) (I_n)	10 kA
Cut-off frequency line-line (f_G)	100 MHz
Voltage supply (230 V)	
SPD class	type 2 / class II
Max. continuous operating voltage (a.c.) [L-N] (U_c)	255 V (50 / 60 Hz)
Max. continuous operating voltage (a.c.) [N-PE] (U_c)	255 V (50 / 60 Hz)
Nominal current (I_L)	10 A
Nominal discharge current (8/20 μ s) (I_n)	5 kA
Max. discharge current (8/20 μ s) (I_{max})	10 kA
Voltage protection level [L-N] (U_P)	≤ 1.5 kV
Voltage protection level [N-PE] (U_P)	≤ 1.5 kV
General parameters	
Approvals	EAC



BLITZDUCTOR VT

- Cost-effective protection of stranded signal lines
- Interface-specific versions, e.g. RS485 or telecommunication systems
- Versions for d.c. power supply systems and cathodic protection



Compact DIN rail mounted surge protective device with screw terminals for stranded lines.

Compact SPDs –
DIN Rail Mounted

BLITZDUCTOR VT is a family of compact DIN rail mounted arresters and consists of different types of enclosure with different connection methods. Devices are, for example, available for protecting four-wire signal interfaces with screw connections or for the terminal equipment of telecommunication systems and telephone systems with RJ connection. All types can be mounted on DIN rails and are earthed via a screw terminal.

In cathodic protection systems, the protective circuit and the voltage measuring circuit are protected against surge impulses resulting from atmospheric discharges (lightning strikes) or switching operations (in power supply lines).

The devices are designed for operation in case of permanent interference voltages up to 65 V a.c. between the pipeline and earth. If this value is exceeded, the relevant touch protection regulations must be observed and further measures taken.

The devices can be overloaded with overcurrents resulting from mains faults (short-circuit or earth fault). For this reason, installation in a separate metal housing is recommended. Thermal overload of the discharge paths is signalled by the integrated remote signalling contact.

Different types of BLITZDUCTOR VT arresters are available depending on the application.



BVT version with a width of 1.5 modules and screw terminals:
BVT AVD/ALD:
Two protected lines for d.c. power supply systems



BVT version with a width of <3 modules and screw terminals:
BVT RS485 specifically designed for protecting RS485 / RS422 interfaces.



BVT version with a width of 1.5 modules and RJ connection:
BVT TC1 for protecting telecommunication interfaces.



BVT version for protecting active corrosion protection systems.

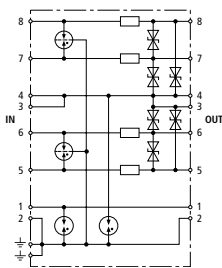

BVT RS485

Surge arrester for a wide range of applications, e.g. for balanced four-wire RS485/422 interfaces or temperature sensors. Direct or indirect shield earthing, connection of a signal ground (SG).

Type BVT ...	RS485 5
Part No.	918 401
SPD class	TYPE 2 P1
Max. continuous operating voltage (d.c.) (U_c)	6 V
Nominal current (I_L)	0.5 A
D1 Lightning impulse current (10/350 μ s) per line (I_{imp})	0.8 kA
C2 Total nominal discharge current (8/20 μ s) (I_n)	10 kA
Series resistance per line	1.8 ohms
Cut-off frequency line-line (f_G)	1.7 MHz
Approvals	CSA, EAC

Compact SPDs –
DIN Rail Mounted

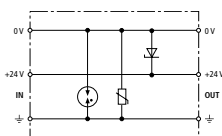

BVT AVD

Surge arresters with improved voltage protection levels for EMC protection of electronic components with d.c. voltage supply. Ideally suited for Siemens PLCs. Since a unipolar diode is used, the polarity of the operating voltage must be observed.

Type BVT ...	AVD 24
Part No.	918 422
SPD class	TYPE 3 P1
Max. continuous operating voltage (d.c.) (U_c)	35 V
Nominal current at 80 °C (I_L)	10 A
C2 Total nominal discharge current (8/20 μ s) (I_n)	2 kA
Approvals	EAC

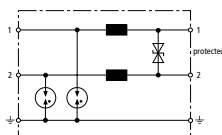

BVT ALD

Energy-coordinated, DIN rail mounted combined lightning current and surge arrester for protecting unearthed d.c. power supply systems.

Type BVT ...	ALD 36	ALD 60
Part No.	918 408	918 409
SPD class	TYPE 1 P1	TYPE 1 P1
Max. continuous operating voltage (d.c.) (U_c)	45 V	65 V
Nominal current at 80 °C (I_L)	4 A	4 A
Nominal current at 45 °C (I_L)	7 A	7 A
Backup fuse if	—	$U_N \geq 45$ V and $I_L \geq 1$ A
D1 Lightning impulse current (10/350 μ s) per line (I_{imp})	2.5 kA	2.5 kA
D1 Total lightning impulse current (10/350 μ s) (I_{imp})	5 kA	5 kA
C2 Total nominal discharge current (8/20 μ s) (I_n)	20 kA	20 kA
Series resistance per line	22 μ H	22 μ H
Approvals	UL, EAC	UL, EAC

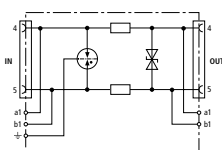

BVT TC

Energy-coordinated and leakage-current-free surge arrester for a/b lines, ISDN U_{k0} or ADSL with RJ45 connections and additional screw terminals. Pinning of the RJ45 sockets is compatible with RJ11/12. The parallel screw terminals are more robust than the RJ45 sockets and increase the total nominal discharge current to 10 kA.

Type BVT ...	TC 1
Part No.	918 411
SPD class	TYPE 2 P2
Max. continuous operating voltage (d.c.) (U_c)	170 V
Nominal current (I_L)	0.2 A
D1 Lightning impulse current (10/350 μ s) per line (I_{imp})	1 kA
C2 Total nominal discharge current (8/20 μ s) (I_n)	5 kA
Series resistance per line	4.7 ohms
Cut-off frequency line-line (f_G)	17 MHz
Approvals	EAC

BVT KKS ALD

Energy coordinated combined arrester for protecting the rectifier in the protective circuit (red colour). Pluggable remote signalling contact (break contact) for overload indication (temperature monitoring of the varistors). Installation in sheet metal housing recommended. Low impulse sparkover voltage due to capacitive control.

Type BVT ...	KKS ALD 75
Part No.	918 420
SPD class	TYPE 1P1
Max. continuous operating voltage (d.c.) (U_c)	75 V
Nominal current (I_L)	12 A
D1 Lightning impulse current (10/350 μ s) per line (I_{imp})	3.5 kA
D1 Total lightning impulse current (10/350 μ s) (I_{imp})	7 kA
C2 Total nominal discharge current (8/20 μ s) (I_n)	40 kA
Series resistance per line	5 μ H
Cut-off frequency line-line (f_G)	1 MHz
Approvals	EAC
Type of remote signalling contact	break contact

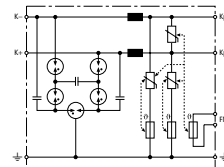



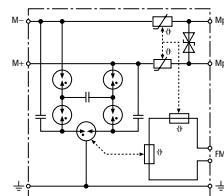

BVT KKS APD

Energy coordinated combined arrester for protecting the voltage measuring circuit (yellow colour). Pluggable remote signalling contact (break contact) for overload indication (temperature monitoring of the discharge paths). Installation in sheet metal housing recommended. Low impulse sparkover voltage due to capacitive control.







Type BVT ...	KKS APD 36
Part No.	918 421
SPD class	TYPE 1P1
Max. continuous operating voltage (d.c.) (U_c)	36.8 V
Nominal current (I_L)	0.05 A
D1 Lightning impulse current (10/350 μ s) per line (I_{imp})	3.5 kA
D1 Total lightning impulse current (10/350 μ s) (I_{imp})	7 kA
C2 Total nominal discharge current (8/20 μ s) (I_n)	40 kA
Series resistance per line	55 ohms
Approvals	EAC
Type of remote signalling contact	break contact









List of Approvals – BLITZDUCTORconnect – Compact (as of October 2019)

Part No.	Type	ATEX 	IECEX 	CSA-Hazloc 	SIL (up to SIL3)	UL 	CSA 
927 910	BCO CL2 B 180	(●)	(●)		●	●	
927 922	BCO CL2 BE 12	(●)	(●)		●	●	
927 924	BCO CL2 BE 24	(●)	(●)		●	●	
927 925	BCO CL2 BE 48	(●)	(●)		●	●	
927 942	BCO CL2 BD 12	(●)	(●)		●	●	
927 944	BCO CL2 BD 24	(●)	(●)		●	●	
927 945	BCO CL2 BD 48	(●)	(●)		●	●	
927 970	BCO CL2 BE HF 5	(●)	(●)		●	●	
927 971	BCO CL2 BD HF 5	(●)	(●)		●	●	
927 984	BCO CL2 BD EX 24	●(8b)	●(9b)		●	●	

List of Approvals – DEHNconnect (as of October 2019)





Part No.	Type	ATEX 	IECEX 	CSA-Hazloc 	SIL (up to SIL3)	UL 	CSA 	EAC 	EAC 
917 920	DCO SD2 ME 12	●	●		●	●	●	●	
917 921	DCO SD2 ME 24	●	●		●	●	●	●	
917 922	DCO SD2 ME 48	●	●		●	●	●	●	
927 940	DCO SD2 MD 12	●	●		●	●	●	●	
917 941	DCO SD2 MD 24	●	●		●	●	●	●	
917 942	DCO SD2 MD 48	●	●		●	●	●	●	
917 970	DCO SD2 MD HF 5	●	●		●	●	●	●	
917 987	DCO SD2 E 12				●	●	●	●	
917 988	DCO SD2 E 24				●	●	●	●	
917 989	DCO SD2 E 48				●	●	●	●	
917 960	DCO SD2 MD EX 24	●(3)	●(4)	●	●	●	●		●(5)

List of Approvals – BLITZDUCTOR VT (as of October 2019)

Part No.	Type	ATEX 	IECEX 	CSA-Hazloc 	SIL (up to SIL3)	UL 	CSA 	EAC 
918 401	BVT RS485 5						●	●
918 408	BVT ALD 36					●		●
918 409	BVT ALD 60					●		●
918 411	BVT TC 1							●
918 420	BVT KKS ALD 75							●
918 421	BVT KKS APD 36							●
918 422	BVT AVD 24							●

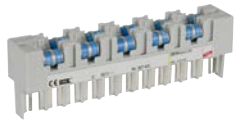
(1b)	KEMA 09ATEX0124 X: II 2(1) G Ex ia IIC T4 Gb
(2b)	DEK 13.0033X: Ex ia [ia Ga] IIC T4...T6 Gb
(3b)	DEKRA 12ATEX0261 X: II 2(1) G Ex ia [ia Ga] IIC T4...T6 Gb
(4b)	DEK 12.0076 X: Ex ia [ia Ga] IIC T4...T6 Gb
(5b)	EAC TC TU C-DE-GB06.B.00505 0ExIIC T4/T5/T6
(6b)	DEKRA 17ATEX0046 X: II 3 G Ex IIC T4...T6 Gc
(7b)	IECEX DEK 17 0023X: Ex ec IIC T4...T6 Gc

(8b)	TÜV 19 ATEX 8476 X: II (1)2 G Ex ia [ia Ga] IIC T6 Gb TÜV 19 ATEX 8476 X: II 2 G Ex ib IIC T6 Gb TÜV 19 ATEX 8476 X: II (1) D [Ex ia Da] IIIC
(9b)	IECEX TUR 20.0025X: Ex ia [ia Ga] IIC T6 Gb IECEX TUR 20.0025X: Ex ib IIC T6 Gb IECEX TUR 20.0025X: [Ex ia Da] IIIC
(●)	Approval pending

Description	Type	Product	Part No.	Page
Lightning current / surge arresters				
<ul style="list-style-type: none"> – Lightning current carrying DRL plug-in SPD block can be easily plugged into LSA disconnection blocks of 2/10 type – Versions with / without fail-safe function / visual indication – Modularly expandable with a DRL protective plug to a combined lightning current and surge arrester – With integrated disconnection block contacts 	DRL 10 B 180 DRL 10 B 180 FSD		907 400 907 401	197 197
<ul style="list-style-type: none"> – Protective plug for one pair inserted through the earthing frame into the DRL plug-in SPD block – Energy-coordinated with DRL plug-in SPD block – Low voltage protection level for application-specific protection of terminal equipment 	DRL ...		907 420 – 907 470	197 – 198
<ul style="list-style-type: none"> – Earthing module inserted through the earthing frame into the LSA disconnection block – Fast replacement when retrofitting a DEHNrapid LSA protection module 	EM 2 DRL		907 496	199
<ul style="list-style-type: none"> – Snap-on earthing frame for earthing and mounting DRL protective plugs on a 10-pair disconnection block or the lightning current carrying DRL plug-in SPD block 	EF 10 DRL		907 498	199

Surge arresters				
<ul style="list-style-type: none"> – Powerful SPD block can be easily plugged into LSA disconnection blocks of 2/10 type – Versions with / without fail-safe function / visual indication 	DPL 10 G3 110 DPL 10 G3 110 FSD		907 214 907 216	200 200

DEHN enclosure for equipotential bonding				
<ul style="list-style-type: none"> – Lightning current carrying earthing system for arresters and shield connection – Pre-mounted mounting frame – Lockable enclosure 	DPG LSA ... P		906 100 – 906 103	201 – 201

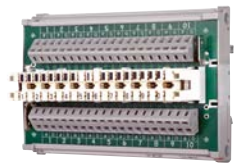
Routing module for disconnection blocks with LSA spring-loaded terminal				
<ul style="list-style-type: none"> – DIN rail mounted routing module for disconnection blocks – Equipped with LSA disconnection block and spring-loaded terminals for variable wire connection – Routing of different wire diameters 	TL2 10DA CC		907 991	203



DEHNrapid LSA – Lightning Current / Surge Arrester



- Variable protection for 1 to 10 pairs in LSA systems of the 2/10 series
- LSA disconnection block function integrated in the lightning current arrester allows protected testing, disconnecting and patching
- Modular system of lightning current and surge arresters can be combined to a single combined arrester

The DEHNrapid LSA arrester series is a modular system of lightning current arresters, surge arresters or combined lightning current and surge arresters that can be plugged into LSA disconnection blocks of series 2. The lightning current carrying 10-pair plug-in SPD block incorporates gas discharge tubes (optionally available with visual fault indication) and disconnection block contacts. This allows testing, disconnecting or patching of pairs with plugged-in protection or the additional attachment of single-pair surge arresters to ensure optimal protection of terminal equipment. The surge arresters snap into the earthing frame and can be removed as a block, whenever required.

nection block contacts. This allows testing, disconnecting or patching of pairs with plugged-in protection or the additional attachment of single-pair surge arresters to ensure optimal protection of terminal equipment. The surge arresters snap into the earthing frame and can be removed as a block, whenever required.

SPDs for LSA Technology

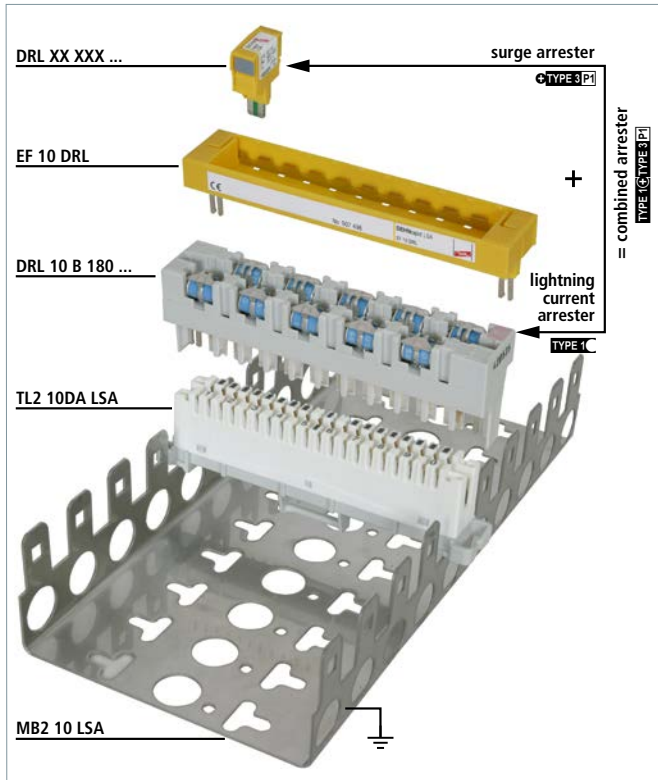

Modular design consisting of a plug-in SPD block with gas discharge tubes, earthing frame and application-specific protection modules.



Combined lightning current and surge arrester for LSA terminal blocks.



Lightning current carrying SPD block with gas discharge tubes optionally available with visual fault indication and fail-safe function.



Application-specific surge protection modules for protecting terminal equipment.



Pluggable surge arresters in the form of protection magazines can be plugged into terminal or disconnection blocks.

DRL 10 B

Lightning current carrying DRL plug-in SPD block (10 pairs), expandable with DRL protective plug. Integrated disconnection block contacts allow protected testing, measuring and patching.

Type DRL ...	10 B 180
Part No.	907 400
SPD class	TYPE 1C
Max. continuous operating voltage (d.c.) (U_c)	180 V
Nominal current (I_L)	0.4 A
D1 Total lightning impulse current (10/350 μ s) (I_{imp})	5 kA
C2 Total nominal discharge current (8/20 μ s) (I_n)	10 kA
Series resistance per line	≤ 0.005 ohms
Plugs into	LSA disconnection block 2/10
Approvals	EAC

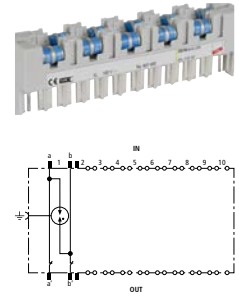

DRL 10 B FSD

Lightning current carrying DRL plug-in SPD block (10 pairs), expandable with DRL protective plug. Integrated disconnection block contacts allow protected testing, measuring and patching. Arrester with fail-safe function and visual fault indicator.

Type DRL ...	10 B 180 FSD
Part No.	907 401
SPD class	TYPE 1C
Fault indication	visual, colour change
Max. continuous operating voltage (d.c.) (U_c)	180 V
Nominal current (I_L)	0.4 A
D1 Total lightning impulse current (10/350 μ s) (I_{imp})	5 kA
C2 Total nominal discharge current (8/20 μ s) (I_n)	10 kA
Series resistance per line	≤ 0.005 ohms
Plugs into	LSA disconnection block 2/10
Approvals	EAC

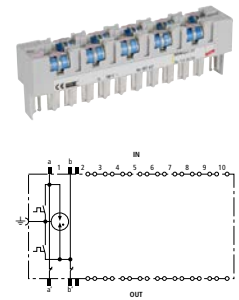

SPDs for LSA Technology

DRL RE

Single-stage protective plug (one pair) for signal circuits sharing a common potential. Earthing via EF 10 DRL earthing frame. For disconnection blocks or lightning current carrying DRL plug-in SPD blocks only.

General technical data:	
SPD class	TYPE 3P1
D1 Total lightning impulse current (10/350 μ s) in combination with DRL 10 B... (I_{imp})	5 kA
C2 Total nominal discharge current (8/20 μ s) in combination with DRL 10 B... (I_n)	10 kA
Plugs into	LSA disconnection block 2/10 or DRL 10 B ... plug-in SPD block
Approvals	EAC

Type DRL ...	RE 12	RE 24	RE 48
Part No.	907 421	907 422	907 423
Max. continuous operating voltage (d.c.) (U_c)	14 V	28 V	54 V
Nominal current (I_L)	0.4 A	0.4 A	0.4 A
Series resistance per line	4.7 ohms	4.7 ohms	6.8 ohms
Cut-off frequency line-PG (f_G)	2.7 MHz	4.5 MHz	7.35 MHz

Type DRL ...	RE 60	RE 180
Part No.	907 424	907 425
Max. continuous operating voltage (d.c.) (U_c)	70 V	180 V
Nominal current (I_L)	0.4 A	0.1 A
Series resistance per line	6.8 ohms	4.7 ohms
Cut-off frequency line-PG (f_G)	10.5 MHz	42 MHz

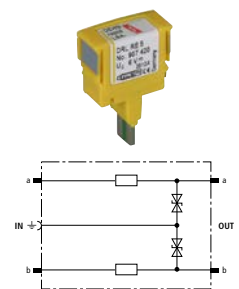

DRL RD

Single-stage protective plug (one pair) for galvanically isolated interfaces. To be mounted into EF 10 DRL earthing frames. Installation recommended only in combination with lightning current carrying DRL plug-in SPD block.

General technical data:	
SPD class	⚡TYPE 3 P1
Nominal current (I _n)	0.4 A
D1 Total lightning impulse current (10/350 μs) in combination with DRL 10 B... (I _{imp})	5 kA
C2 Total nominal discharge current (8/20 μs) in combination with DRL 10 B... (I _n)	10 kA
Plugs into	LSA disconnection block 2/10 or DRL 10 B ... plug-in SPD block
Approvals	EAC

Type DRL ...	RD 12	RD 24	RD 48
Part No.	907 441	907 442	907 443
Max. continuous operating voltage (d.c.) (U _c)	14 V	28 V	54 V
Series resistance per line	2.2 ohms	2.2 ohms	4.7 ohms
Cut-off frequency line-line (f _c)	2.7 MHz	5.4 MHz	7.8 MHz

Type DRL ...	RD 60	RD 110
Part No.	907 444	907 445
Max. continuous operating voltage (d.c.) (U _c)	70 V	180 V
Series resistance per line	4.7 ohms	4.7 ohms
Cut-off frequency line-line (f _c)	11 MHz	20 MHz

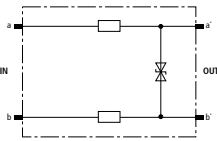

DRL PD

Single-stage protective plug with overcurrent protection (one pair) for ADSL, ISDN U_{k0} or a/b lines. To be mounted into EF 10 DRL earthing frames. Installation recommended only in combination with lightning current carrying DRL plug-in SPD block.

Type DRL ...	PD 180
Part No.	907 430
SPD class	⚡TYPE 3 P1
Max. continuous operating voltage (d.c.) (U _c)	180 V
Nominal current (I _n)	0.1 A
D1 Total lightning impulse current (10/350 μs) in combination with DRL 10 B... (I _{imp})	5 kA
C2 Total nominal discharge current (8/20 μs) in combination with DRL 10 B... (I _n)	10 kA
Series resistance per line	10 ohms +/- 15%
Cut-off frequency line-line (f _c)	61 MHz
Plugs into	LSA disconnection block 2/10 or DRL 10 B... plug-in SPD block
Approvals	EAC

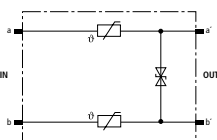

DRL HD

Single-stage protective plug (1 pair) for high-frequency transmissions (e.g. ISDN U_{2m}, S_{2m} and S₀). HD 5 type for RS 485 bus systems. To be mounted into EF 10 DRL earthing frames. Installation recommended only in combination with lightning current carrying DRL plug-in SPD block.

Type DRL ...	HD 24
Part No.	907 470
SPD class	⚡TYPE 3 P1
Max. continuous operating voltage (d.c.) (U _c)	28 V
Nominal current (I _n)	0.4 A
D1 Total lightning impulse current (10/350 μs) in combination with DRL 10 B... (I _{imp})	5 kA
C2 Total nominal discharge current (8/20 μs) in combination with DRL 10 B... (I _n)	10 kA
Series resistance per line	4.7 ohms
Cut-off frequency line-line (f _c)	94 MHz
Plugs into	LSA disconnection block 2/10 or DRL 10 B... plug-in SPD block
Approvals	EAC

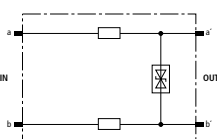



Accessories for DEHNrapid LSA

Plug-in SPD Block (without SPDs)

Plug-in SPD block (without SPDs) for 1 to max. 10 three-pole GDT 230 B3 ... gas discharge tubes. Also suitable for DRL protective plugs with earthing frame.

Type	BM 10 DRL
Part No.	907 499
Plugs into	LSA disconnection blocks
Earthing via	mounting frame



Gas Discharge Tube

High-capacity replacement gas discharge tube for DRL 10 or BM 10 DRL. Three-pole version with common arcing chamber for a constant voltage protection level line-line and line-ground.

Type	GDT 230 B3 FSD
Part No.	907 219
Integrated into Part No.	907 401
Visual fault indication	yes
Fail-safe spring	yes
D1 Total lightning impulse current (10/350 µs)	5 kA



Gas Discharge Tube

High-capacity replacement gas discharge tubes for DRL 10 or BM 10 DRL. Three-pole version with common arcing chamber for a constant voltage protection level line-line and line-ground.

Type	GDT 230 B3
Part No.	907 218
Integrated into Part No.	907 400
D1 Total lightning impulse current (10/350 µs)	5 kA



Earthing Frame

Snap-on earthing frame for earthing and installation of max. 10 DRL protection modules. Plugs into a 10-pair disconnection block or DRL plug-in SPD block.

Type	EF 10 DRL
Part No.	907 498
Plugs into	LSA disconnection blocks or DRL plug-in SPD block
Earthing via	mounting frame or DRL plug-in SPD block



Label Holder

Universal label holder made of stainless steel for clear labelling of LSA connections. Can be snapped onto DEHNrapid LSA plug-in SPD blocks, earthing frames with protective plugs or mounting frames with LSA blocks of the 2/10 series.

Type	SR DRL
Part No.	907 497
Plugs into	DRL B, EF DRL, LSA blocks 2/10 (profile, with earth connecting clip)



Earthing Module

Earthing module for directly connecting two unused lines to the equipotential bonding system.

Type	EM 2 DRL
Part No.	907 496
D1 Total lightning impulse current (10/350 µs)	5 kA
Plugs into	TL2 10DA ...
Earthing via	EF 10 DRL
Material	zinc die-casting
Approvals	EAC





DPL 10 G3



Pluggable arresters for use in LSA systems of the 2/10 series. For use as protection block for 10 pairs with individually exchangeable protection elements.

- Suitable for disconnection or terminal blocks of LSA systems of the 2/10 series
- Equipped with individually tested gas discharge tubes for ten pairs
- Individually exchangeable protection elements (gas discharge tubes)

Pluggable surge arresters for use as protection blocks in IT systems and devices which have to be connected via terminal or disconnection blocks using the LSA insulation displacement method. Installation onto terminal blocks, however, is the preferred method, as their contact forces provide better fixation – even in case of slight vibrations.

The surge arresters for 10 pairs can be easily installed and removed for testing purposes. Contact to earth via the mounting frame is automatically established as soon as the arrester is plugged in. After being overloaded, the protection elements can be individually replaced.

SPDs for LSA Technology

DPL 10 G3

Plug-in SPD block for ten pairs with three-pole gas discharge tubes for almost all applications. FSD arresters feature a fail-safe function and an additional visual indication when the fail-safe function has been activated. Thus, it can be immediately identified whether an arrester has to be replaced.

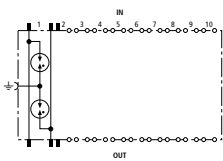

Type DPL 10 G3 ...	110	110 FSD
Part No.	907 214	907 216
SPD class	TYPE 2	TYPE 2
Fault indication	—	visual, colour change
Max. continuous operating voltage (d.c.) (U _c)	180 V	180 V
Nominal current (I _n)	0.4 A	0.4 A
C2 Total nominal discharge current (8/20 μs) (I _n)	10 kA	10 kA
Approvals	EAC	EAC

Accessories for DPL 10 G3

Gas Discharge Tube

High-capacity replacement gas discharge tubes for DPL 10 G3. Three-pole version with common arcing chamber for a constant voltage protection level line-line and line-ground.



Type	GDT 230 G3	GDT 230 G3 FSD
Part No.	907 208	907 217
Integrated into Part No.	907 214	907 216
Visual fault indication	—	yes
Fail-safe spring	—	yes



DEHN Enclosure for Equipotential Bonding

- Premounted enclosure system for wiring and protection components
- Tested lightning impulse current carrying capacity
- Optimised for equipotential bonding (surge arresters and shield connection)
- Lockable metal enclosure to prevent unauthorised access

Lightning current carrying enclosure with IP 40 degree of protection for different distribution board designs and for the insertion of surge arresters. The cover can be removed from the wall plate without tools and features a lock with cylinder quarter turn and a key. The C-shaped design of the wall plate allows side and front access during installation work. LSA mounting frames or DIN rails can be mounted on the wall plate with cable entry plates and cable rails.

Structured cable management despite high packing density - crossing of cables and wires is avoided and the cabling, e.g. in the LSA blocks, is neatly arranged thanks to the 30 mm spacing. An optional shield connection system (constant force spring) is available for this cabling. The well-conceived earthing system permanently connects all conductive components of the enclosure system to the earthing block via mechanical contact or earthing conductors.

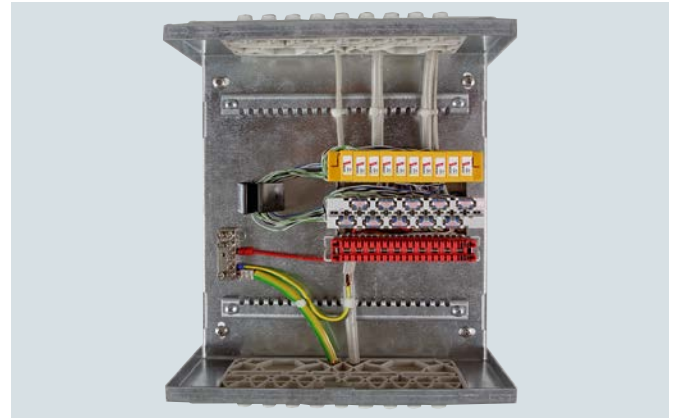

DEHN enclosures for equipotential bonding (DPG) are lockable metal enclosures ready for installing wiring and protection components. Available in four different sizes, the lightning current carrying enclosures provide terminals for integrating surge arresters and shields in the equipotential bonding system.



DEHN enclosures for equipotential bonding (DPG) come in different sizes for fitting with 3/6/12/22 LSA blocks. This means that when 20/50/100/200 pairs are connected, there is still enough space left for the earthing plug for connecting the shield wires.

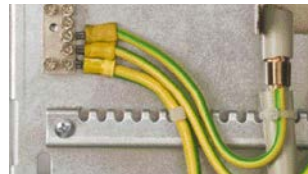

All equipotential bonding conductors are led brought together in the central earthing block.



The shields of incoming lines can be contacted with SA KRF constant force springs in a space-saving and lightning-current-carrying way.



The enclosure for equipotential bonding can be locked (key supplied with the enclosure).

DPG LSA

DPG LSA is a completely premounted enclosure system with LSA mounting frame and allows optimised use of arresters and shield connection systems (constant force spring).

Type DPG LSA ...	30 P	60 P	120 P	220 P
Part No.	906 100	906 101	906 102	906 103
Carrying capacity of connection elements D1	15 kA	30 kA	50 kA	50 kA
Total lightning impulse current (10/350 µs) (I_{imp})				
LSA mounting frame for	1x 3 blocks 2/10	1x 6 blocks 2/10	2x 6 blocks 2/10	2x 11 blocks 2/10
Wire guides	1 pc(s).	2 pc(s).	2 pc(s).	3 pc(s).
Degree of protection	IP 40	IP 40	IP 40	IP 40
Dimensions W x H x D	240 x 260 x 130 mm	240 x 350 x 130 mm	330 x 350 x 130 mm	330 x 500 x 130 mm



Accessories for DEHN Enclosure for Equipotential Bonding

Self-bonding Rubber Tape

Roll with 9 m self-bonding rubber tape to be wrapped around constant force springs for permanent corrosion protection.

Type	SKB 19 9M SW
Part No.	919 030
Colour	black ●



Constant Force Spring

Constant force springs allow solderless shield connections for equipotential bonding or lightning equipotential bonding. They can be installed subsequently without interrupting the cable shield or requiring tools for installation. Approved for nuclear installations according to TÜV Certificate No. T12-04-ETL003 (TÜV = German Technical Inspectorate).

Type	SA KRF 10 V2A	SA KRF 15 V2A	SA KRF 22 V2A	SA KRF 29 V2A	SA KRF 37 V2A
Part No.	919 031	919 032	919 033	919 034	919 035
Material	StSt	StSt	StSt	StSt	StSt
Clamping range	4-10 mm	9-15 mm	14-22 mm	18.5-29 mm	23.5-37 mm





Accessories for LSA Technology

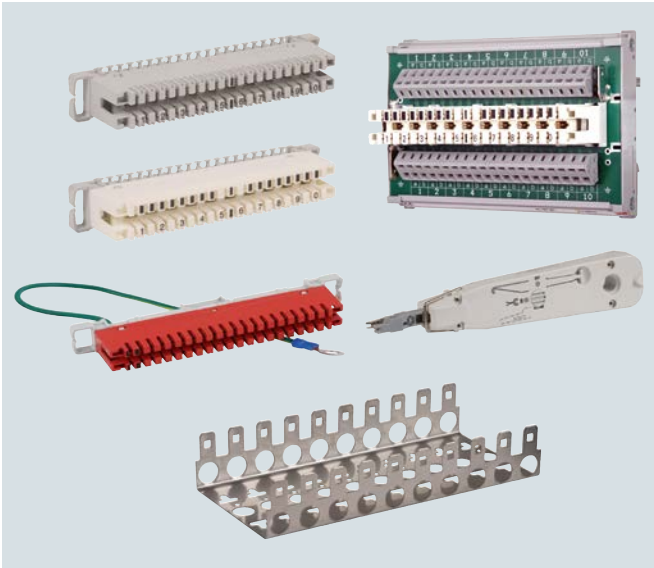

- Proven insulation displacement method
- 45° angled blades in the disconnection block ensure a minimum change in cross-section
- Enhanced stability of the conductor
- Enhanced corrosion resistance
- Further accessories available on request

The insulation displacement method is used when a large number of lines need to be connected quickly and at low cost. This method is commonly used in the telecommunications sector (e.g. Deutsche Telekom AG).

The blocks are suitable for connecting plastic-insulated wires with copper conductor material:

Conductor diameter: 0.4-0.8 mm

Outer diameter: 0.7-1.5 mm

After using wires with a conductor diameter of 0.65 mm, rewiring to smaller diameters is no longer possible.

Mounting Frame

Mounting frame for 10 LSA blocks of the 2/10 series, total width: 104.5 mm



Type	MB2 10 LSA
Part No.	907 995
Dimensions	223 x 105 x 42 mm

Insertion Tool

Insertion tool with sensor for LSA technology for connecting the wires and simultaneously cutting them to the required length. With fold-out extraction hook and blade.



Type	AW2 LSA
Part No.	907 994
Colour	white

Terminal Block

Series 2 for LSA technology for inseparably connecting 10 pairs each on the cable and routing side. Accommodates DPL 10 G3 arresters. Parallel protective circuit only.



Type	AL2 10DA LSA
Part No.	907 997
Test standards	DIN 47608-1, -2
Diameter of solid conductors	0.40-0.80 mm
Conductor diameter with insulation	0.70-1.50 mm

Disconnection Block

Series 2 for LSA technology for connecting 10 pairs each on the cable and routing side. Protection is provided between the disconnection contacts as soon as DRL components are plugged in. DPL 10 G3 arresters can also be plugged into the disconnection block.

Type	TL2 10DA LSA
Part No.	907 996
Test standards	DIN 47608-1, -2
Approvals	compliance with DTAG TS 0272/96
Diameter of solid conductors	0.40-0.80 mm
Conductor diameter with insulation	0.70-1.50 mm



Earthing Plug

Series 2 for LSA technology for connecting up to 38 earth drain wires or unused signal cores. With earth wire and M4 ring cable lug.

Type	EL2 38EA LSA
Part No.	907 993
Earthing via	earthing conductor with M4 ring cable lug
Diameter of solid conductors	0.40 - 0.80 mm
Conductor diameter with insulation	0.70 - 1.50 mm
Colour	red



Routing Module for Disconnection Blocks with LSA Spring-Loaded Terminal

DIN rail mounted routing module with LSA disconnection block of the 2/10 series as well as spring-loaded terminals for variable wire connection. DPL and DEHNrapid LSA surge arresters can be plugged into the routing module.



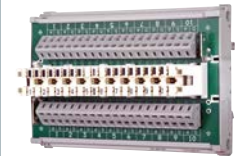







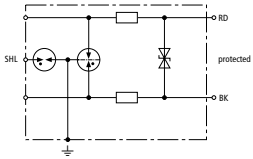

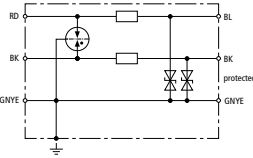

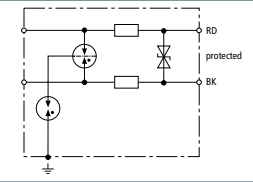

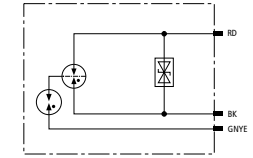
Type	TL2 10DA CC
Part No.	907 991
Carrying capacity of connection components D1 Total lightning impulse current (10/350 µs) (I _{imp})	5 kA
For mounting on	35 mm DIN rails acc. to EN 60715
Connection (input / output)	spring or LSA / spring or LSA
Earthing via	DIN rail / flat connector 6.3 mm
Diameter of solid conductors	0.40-0.80 mm
Conductor diameter with insulation	0.70-1.60 mm

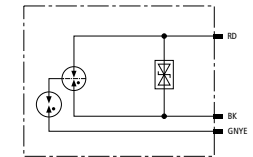

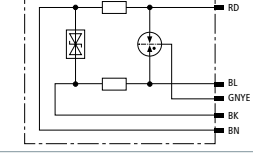

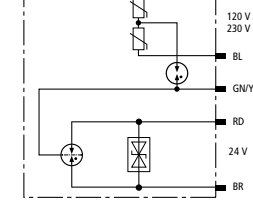
DEHN protects.

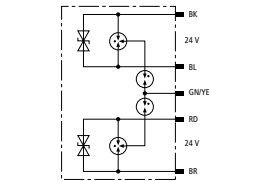

Basic circuit diagram	Type	Product	Part No.	Page
DEHNpipe MD / ME				
	DPI MD <ul style="list-style-type: none"> – For one balanced interface – Direct or indirect shield earthing – Nominal voltage: 24 V – For series connection – With M20 x 1.5 thread (female/male) 		929 941	206
	DPI ME <ul style="list-style-type: none"> – For one unbalanced interface – Nominal voltage: 24 V – For series connection – With 1/2-14 NPT thread (male/male) 		929 921	206
DEHNpipe MD Ex (i)				
	DPI MD EX <ul style="list-style-type: none"> – For one balanced interface – Nominal voltage: 24 V – For series connection – With M20 x 1.5 or 1/2-14 NPT thread 		929 960 929 965	207 207
DEHNpipe CD Ex (i)				
	DPI CD EXI <ul style="list-style-type: none"> – For one balanced interface – Nominal voltage: 24 V – For parallel connection – With M20 x 1.5 or 1/2-14 NPT thread 		929 961 929 963	207 207
DEHNpipe CD Ex (d)				
	DPI CD EXD 24 <ul style="list-style-type: none"> – For one balanced interface – Nominal voltage: 24 V – For parallel connection – With M20 x 1.5 or 1/2-14 NPT thread 		929 962 929 964	207 207
	DPI CD HF EXD 5 <ul style="list-style-type: none"> – For one balanced interface – Nominal voltage: 5 V – For series connection – With M20 x 1.5 thread 		929 971	207
	DPI CD EXD 230 24 <ul style="list-style-type: none"> – For one balanced interface and one 120/230 V power supply system – Nominal voltage: 24 V and 120/230 V – For parallel connection – With M20 x 1.5 or 1/2-14 NPT thread 		929 969 929 970	208 208
DEHNpipe CD Ex (i) + Ex (d)				
	DPI CD EXI+D 2x24 <ul style="list-style-type: none"> – For two balanced interfaces – Nominal voltage: 24 V – For parallel connection – With M20 x 1.5 or 1/2-14 NPT thread 		929 950 929 951	208 208



DEHNpipe



Surge arrester for outdoor use to be screwed onto two-wire field devices. Stainless steel, installation with cable gland up to IP 67.

- Surge arresters to be screwed onto field devices
 - Parallel or series connection
 - Made of corrosion-resistant stainless steel
 - Arrester for protecting a second interface (data or power side) available
- Types for Ex (i) and Ex (d) applications
 - For protecting intrinsically safe measuring circuits and bus systems Ex (i)
 - Type in a flameproof enclosure Ex (d)
- Variety of approvals
 - Approvals depending on the arrester: IECEx, ATEX, FISCO, CSA Hazloc

The devices of the DEHNpipe family are made of corrosion-resistant stainless steel and can be directly screwed onto a field device. The permanently connected lines are connected to the terminals of the field device. Surge protective devices for series connection and parallel connection are available. Arresters for series connection are located directly in the cable run which ensures energy coordination with other arresters. These arresters can also be used for field devices with a single field device terminal or a single cable gland. Arresters for parallel connection are attached to the spare cable gland of the field devices or in the field bus distributor and are situated in parallel to the cable run. Due to their design, both versions have an IP 67 degree of protection.

Ex(i) und Ex(d) versions are available for field devices in potentially explosive atmospheres. Depending on the type, the arresters can thus be installed on field devices in intrinsically safe measuring circuits Ex(i) or on devices with flameproof enclosure and are suitable for use in Ex zone 1 or 2.

The surge arresters are ideally suited for installation in process environments, for example on transducers or field bus devices. 4-20 mA measuring circuits or bus systems up to 30 V are typical fields of application.

SPDs for Field Devices



Types for series connection.



Robust type made of corrosion-resistant stainless steel.



Metric and NPT thread.



ATEX and IECEx approval.

DPI MD

Energy-coordinated two-stage arrester, no leakage currents to earth, for 4-20 mA interfaces with M20 x 1.5 thread (female/male). Direct, indirect or no shield earthing. Cable gland available as an accessory.

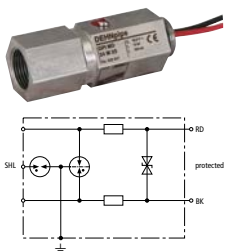

Type DPI ...	MD 24 M 2S
Part No.	929 941
SPD class	TYPE 2 PI
Max. continuous operating voltage (d.c.) (U _c)	34.8 V
Nominal current (I _n)	0.5 A
D1 Lightning impulse current (10/350 μs) per line (I _{imp})	1 kA
C2 Total nominal discharge current (8/20 μs) (I _n)	10 kA
Cut-off frequency line-line (f _c)	14 MHz
For mounting on (field / device side)	M20 x 1.5 female thread / M20 x 1.5 male thread
Approvals	EAC, SIL

DPI ME

Energy-coordinated two-stage arrester for unbalanced interfaces with 1/2-14 NPT thread (male/male). The earthing conductor is led through the surge arrester.

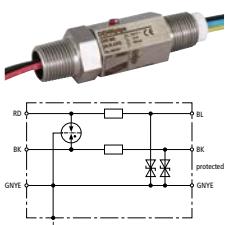

Type DPI ...	ME 24 N A2G
Part No.	929 921
SPD class	TYPE 2 PI
Max. continuous operating voltage (d.c.) (U _c)	34.8 V
Nominal current (I _n)	0.5 A
D1 Lightning impulse current (10/350 μs) per line (I _{imp})	1 kA
C2 Total nominal discharge current (8/20 μs) (I _n)	10 kA
For mounting on (field / device side)	1/2-14 NPT male thread / 1/2-14 NPT male thread
Approvals	UL, EAC, SIL

DPI MD EX

Energy-coordinated two-stage surge arrester for protecting intrinsically safe measuring circuits and bus systems according to FISCO. Cable glands are available as an accessory.

Type DPI ...	MD EX 24 M 2	MD EX 24 N 2
Part No.	929 960	929 965
SPD class	TYPE 2 P1	TYPE 2 P1
Max. continuous operating voltage (d.c.) (U _c)	34.8 V	34.8 V
Nominal current (I _n)	0.5 A	0.5 A
D1 Lightning impulse current (10/350 μs) per line (I _{imp})	1 kA	1 kA
C2 Total nominal discharge current (8/20 μs) (I _n)	10 kA	10 kA
Cut-off frequency line-line (f _c)	7 MHz	7 MHz
For mounting on (field / device side)	M20 x 1.5 female thread / M20 x 1.5 male thread	1/2-14 NPT female thread / 1/2-14 NPT male thread
Approvals	EACEx, ATEX, IECEx, SIL	ATEX, IECEx, SIL

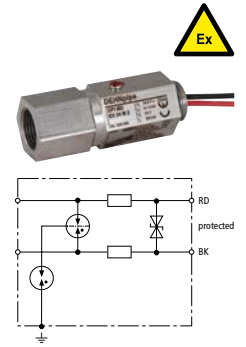

DPI CD EXI

Surge arrester for protecting intrinsically safe measuring circuits and bus systems according to FISCO.

Type DPI ...	CD EXI 24 M	CD EXI 24 N
Part No.	929 961	929 963
SPD class	TYPE 2 P1	TYPE 2 P1
Max. continuous operating voltage (d.c.) (U _c)	32 V	32 V
Nominal current (I _n)	0.55 A	0.55 A
D1 Lightning impulse current (10/350 μs) line-PG (I _{imp})	1 kA	1 kA
C2 Total nominal discharge current (8/20 μs) (I _n)	10 kA	10 kA
Cut-off frequency line-line (f _c)	67 MHz	67 MHz
For mounting on (field / device side)	M20 x 1.5 male thread	1/2-14 NPT male thread
Approvals	EACEx, ATEX, IECEx, CSA & USA Hazloc, SIL	EACEx, ATEX, IECEx, CSA & USA Hazloc, SIL

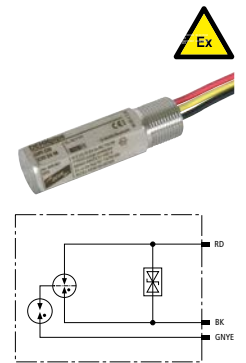

DPI CD EXD

Surge arrester in a flameproof enclosure for protecting measuring circuits and bus systems in potentially explosive atmospheres.

Type DPI ...	CD EXD 24 M	CD EXD 24 N
Part No.	929 962	929 964
SPD class	TYPE 2 P1	TYPE 2 P1
Max. continuous operating voltage (d.c.) (U _c)	32 V	32 V
Nominal current (I _n)	0.55 A	0.55 A
D1 Lightning impulse current (10/350 μs) line-PG (I _{imp})	1 kA	1 kA
C2 Total nominal discharge current (8/20 μs) (I _n)	10 kA	10 kA
Cut-off frequency line-line (f _c)	67 MHz	67 MHz
For mounting on (field / device side)	M20 x 1.5 male thread	1/2-14 NPT male thread
Approvals	EACEx, ATEX, IECEx, CSA & USA Hazloc, SIL	EACEx, ATEX, IECEx, CSA & USA Hazloc, SIL

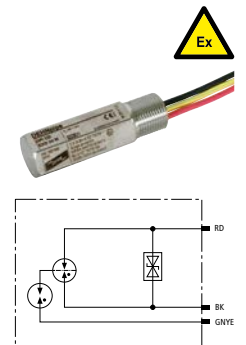

DPI CD HF EXD

Surge arrester in a flameproof enclosure for protecting measuring circuits and bus systems with high-frequency signals in potentially explosive atmospheres.

Type DPI ...	CD HF EXD 5 M
Part No.	929 971
SPD class	TYPE 2 P1
Max. continuous operating voltage (d.c.) (U _c)	6 V
Nominal current at 80 °C (I _n)	0.1 A
C2 Total nominal discharge current (8/20 μs) (I _n)	20 kA
Cut-off frequency line-line (f _c)	100 MHz
For mounting on (field / device side)	M20 x 1.5 male thread
Approvals	EACEx, ATEX, IECEx, SIL

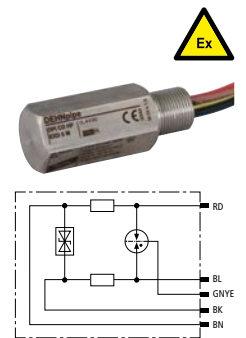

DPI CD EXD 230 24

Surge arrester in a flameproof enclosure for protecting 120/230 V terminal equipment and 0/4-20 mA interfaces in potentially explosive atmospheres.

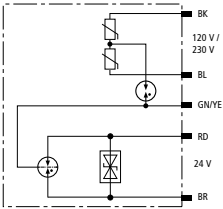

Type DPI ...	CD EXD 230 24 M	CD EXD 230 24 N
Part No.	929 969	929 970
SPD class	TYPE 2P2	TYPE 2P2
Max. continuous operating voltage (d.c.) (U _c)	32 V	32 V
Nominal current at 80 °C (I _n)	0.55 A	0.55 A
D1 Lightning impulse current (10/350 μs) line-PG (I _{imp})	1 kA	1 kA
C2 Total nominal discharge current (8/20 μs) (I _n)	10 kA	10 kA
For mounting on (field / device side)	M20 x 1.5 male thread	1/2-14 npt male thread
Approvals	EACEx, ATEX, IECEx, CSA & USA Hazloc, SIL	EACEx, ATEX, IECEx, CSA & USA Hazloc, SIL

Type DPI ...	CD EXD 230 24 M	CD EXD 230 24 N
Part No.	929 969	929 970
SPD according to EN 61643-11 / IEC 61643-11	type 2 / class II	type 2 / class II
Max. continuous operating voltage (a.c.) (U _c)	255 V	255 V
Total discharge current (8/20 μs) L+N-PE (I _{total})	5 kA	5 kA
Voltage protection level L-N (U _p)	≤ 1.4 kV	≤ 1.4 kV
Max. mains-side overcurrent protection	16 A gG or B 16 A	16 A gG or B 16 A

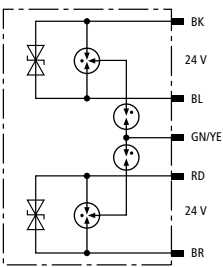

DPI CD EXI+D 2X24

Surge arrester in a flameproof enclosure for protecting two 24 V interfaces in potentially explosive atmospheres according to FISCO.

Type DPI ...	CD EXI+D 2X24 M	CD EXI+D 2X24 N
Part No.	929 950	929 951
SPD class	TYPE 2P1	TYPE 2P1
Max. continuous operating voltage (d.c.) (U _c)	36 V	36 V
Nominal current (I _n)	0.55 A	0.55 A
D1 Lightning impulse current (10/350 μs) line-PG (I _{imp})	1.5 kA	1.5 kA
C2 Total nominal discharge current (8/20 μs) (I _n)	20 kA	20 kA
For mounting on (field / device side)	M20 x 1.5 male thread	1/2-14 NPT male thread
Approvals	EACEx, ATEX, IECEx, CSA & USA Hazloc, SIL	EACEx, ATEX, IECEx, CSA & USA Hazloc, SIL

SPDs for Field Devices

Accessories for DEHNpipe

EMC Cable Gland

Brass gland with shield connection



Type	KV S M20 MS 9.5
Part No.	929 982
Sealing range (Rd)	6.5-9.5 mm
Shield diameter	3.2-6.5 mm
For mounting on	M20 x 1.5
Degree of protection	IP 68

Cable Gland

Brass gland without shield connection



Type	KV M20 MS 10.5
Part No.	929 984
Sealing range (Rd)	7.0-10.5 mm
For mounting on	M20 x 1.5
Degree of protection	IP 68







Brass Earthing Ring

Earthing ring made of nickel-plated brass, for externally earthing DPI devices.



Type	ER DPI M20
Part No.	929 996
For mounting on	DPI M20 x 1.5

List of Approvals (as of October 2019)

Part No.	Type	ATEX 	IECEX 	CSA-Hazloc 	SIL (up to SIL3)	UL 	EAC 	EAC 
929 921	DPI ME 24 N A2G				•	•	•	
929 941	DPI MD 24 M 25				•		•	
929 950	DPI CD EXI+D 2x24 M	•(9)	•(10)	•(12)	•			•(15)
929 951	DPI CD EXI+D 2x24 N	•(9)	•(10)	•(12)	•			•(15)
929 960	DPI MD EX 24 M 2	•(1)	•(2)		•			•(13)
929 961	DPI CD EXI 24 M	•(3)	•(4)	•(12)	•			•(13)
929 962	DPI CD EXD 24 M	•(5)	•(6)	•(11)	•			•(14)
929 963	DPI CD EXI 24 N	•(3)	•(4)	•(12)	•			•(13)
929 964	DPI CD EXD 24 N	•(5)	•(6)	•(11)	•			•(14)
929 965	DPI MD EX 24 N 2	•(1)	•(2)		•			
929 969	DPI CD EXD 230 24 M	•(7)	•(8)	•(11)	•			•(14)
929 970	DPI CD EXD 230 24 N	•(7)	•(8)	•(11)	•			•(14)
929 971	DPI CD HF EXD 5 M	•(5)	•(6)		•			•(14)

(1)	DEKRA 11ATEX0076 X: II 2(1) G Ex ia [ia Ga] IIC T4 ... T6 Gb
(2)	DEK 11.0025X: Ex ia [ia Ga] IIC T4 ... T6 Gb
(3)	KEMA 04ATEX1189 X: II 2(1) G Ex ia IIC T5 ... T6 Gb
(4)	KEM 09.0076X: Ex ia [ia Ga] IIC T5 ... T6 Gb
(5)	KEMA 04ATEX2190 X: II 2 G Ex d IIC T5 or T6 Gb
(6)	KEM 09.0064X: Ex d IIC T5 or T6 Gb
(7)	KEMA 10ATEX0114 X: II 2 G Ex d IIC T5 or T6 Gb
(8)	DEK 11.0006X: Ex d IIC T5 or T6 Gb
(9)	DEKRA 11ATEX0207 X: II 2(1) G Ex ia [ia Ga] IIC T5/T6 Gb DEKRA 11ATEX0217 X: II 2 G Ex db IIC T6...T5 Gb
(10)	IECEX DEK 11.0076X: Ex ia [ia Ga] IIC T5/T6 Gb IECEX DEK 11.0079X: Ex db IIC T6 ... T5 Gb

(11)	CSA 10.2317168: Ex d IIC T4 ... T6 CSA 10.2317168: Class I Div 1, 2; Group A,B,C,D T4 ... T6 CSA 10.2317168: Class II Div 1, 2; Group E,F,G CSA 10.2317168: Class III Div 1, 2 CSA 10.2317168: Class I, AEx d IIC T4 ... T6
(12)	CSA 13.70000407: Class I, Zone 1, AEx ia [ia] IIC T5 ... T6 CSA 13.70000407: Class I, Zone 1, AEx nA IIC T5 ... T6 CSA 13.70000407: IS, Class I, Div 1, Group A,B,C,D,E,F,G T5 ... T6 CSA 13.70000407: Class I,II,III; Div 2, Group A,B,C,D,E,F,G T5 ... T6 CSA 13.70000407: Ex ia [ia] IIC T5
(13)	EAC TC RU C-DE.GB06.B00505 0ExiaIIC T5/T6
(14)	EAC TC RU C-DE.GB06.B00505 1ExdIIC T5/T6 X
(15)	EAC TC RU C-DE.GB06.B00505 0ExiaIIC T5/T6 X EAC TC RU C-DE.GB06.B00505 1ExdIIC T5/T6 X

For more detailed information on approvals and SIL, please visit www.dehn-international.com



DEHN protects.



DEHNpatch

- Patch cable with surge protection
- Cat. 6 according to ISO/IEC 11801
- CAT 6A in the channel according to ANSI/TIA/EIA-568
- Power over Ethernet IEEE 802.3 compliant (up to PoE++ / 4PPoE)
- IP66 variant for outdoor applications
- Easy to retrofit



DEHNpatch is the first Cat. 6A certified patch cable with surge protection that can be used according to IEEE 802.3at up to 57 V.

Surge arresters of the DEHNpatch family fulfil various requirements for a universal application for Ethernet, Industrial Ethernet, Power over Ethernet (IEEE 802.3 compliant up to PoE++ / 4PPoE) as well as general applications in structured cabling up to the Gbit range. Due to the different product designs, the SPDs are suitable for indoor and outdoor installation in different environmental conditions.

The space-saving design of the patch cable or compact socket-socket versions of the DEHNpatch surge arrester makes them particularly easy to install. So, as well as being easy to equip in new systems, retrofitting is possible at any time and without any great effort. Due to its fully shielded design, DEHNpatch can be used in shielded and unshielded networks.

DEHNpatch is installed between the patch panel and the active component (e.g. switch). Safe equipotential bonding is provided by the surge current resistant DIN rail supporting foot with snap-in mechanism. The DEHNpatch with integrated patch cable is delivered with a standard cable

length of 3 m. Arresters with other customised cable lengths of up to 10 m are available on request.

The width of the DIN rail mounted devices is similar to that of an RJ45 socket, allowing up to 24 devices to be installed next to one another in a 19" rack. For multiple application in 19" distribution boards, a DEHNpatch mounting set is recommended and is available as an accessory.

The IP66 version of DEHNpatch with its universal mounting device, especially developed for outdoor applications, can be installed on poles as well as on walls. The arrester is directly earthed via the metal enclosure. Screws in the enclosure cover are secured against falling out which facilitates installation, particularly when working at heights (e.g. on poles). Special cable seals take the effort out of installing the arrester with pre-assembled patch cables because they eliminate the need to mount RJ45 plugs on the lines entering the enclosure.



With RJ45 sockets, fully shielded.



IP66 version suitable for outdoor use.



Patch cable version, fully shielded.



Mounting set (DIN rail, distance bolts) for 19" mounting sections available as an accessory.

DPA CLE IP66

Universal surge arrester for GBit Ethernet applications, Power over Ethernet (IEEE 802.3 compliant up to PoE++ / 4PPoE) and similar applications in structured cabling systems up to class E in indoor and outdoor areas in an IP66 rated enclosure impervious to dust and water. Protection of all pairs with gas discharge tubes and one adapted filter matrix for each pair. Fully shielded surge protective solution with RJ 45 sockets. Universal mounting bracket for pole and wall mounting.

External accessories: Tensioning straps for pole mounting

Type DPA ...	CLE IP66
Part No.	929 221
SPD class	TYPE 2 Pt
Max. continuous operating voltage (d.c.) pair-pair (PoE) (U _c)	60 V
Nominal current (I _n)	1 A
D1 Lightning impulse current (10/350 µs) per line (I _{imp})	0.8 kA
D1 Total lightning impulse current (10/350 µs) total (I _{imp})	4 kA
C2 Total nominal discharge current (8/20 µs) total (I _n)	10 kA
Cut-off frequency (f _c)	250 MHz
Degree of protection (with installed cables)	IP 66
Connection (input / output)	RJ45 socket / RJ45 socket
Approvals	UL, CSA, EAC

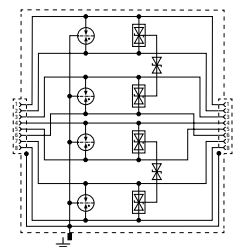

SPDs for Tel. and Data Networks

DPA M CAT6

Universal arrester for Industrial Ethernet, Power over Ethernet (PoE+ according to IEEE 802.3at up to 57 V) and similar applications in structured cabling systems according to Cat. 6 and class E_A up to 500 MHz. Fully shielded type with patch cable for DIN rail mounting.

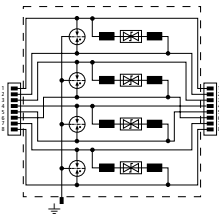

Type DPA ...	M CAT6 RJ45S 48
Part No.	929 100
SPD class	TYPE 2 P1
Max. continuous operating voltage (d.c.) (U _c)	48 V
Max. continuous operating voltage (d.c.) pair-pair (PoE) (U _c)	57 V
Nominal current (I _n)	1 A
D1 Lightning impulse current (10/350 μs) per line (I _{imp})	1 kA
C2 Total nominal discharge current (8/20 μs) total (I _n)	10 kA
Cut-off frequency (f _c)	250 MHz
Connection (input / output)	RJ45 connecting line / RJ45 connecting line
Approvals	GHMT, EAC

DEHNpatch Class E

Universal arrester for Industrial Ethernet, Power over Ethernet (PoE+ according to IEEE 802.3at up to 57 V) and similar applications in structured cabling systems according to class E up to 250 MHz. Fully shielded adapter with sockets for DIN rail mounting.

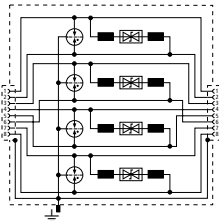

Type DPA ...	M CLE RJ45B 48
Part No.	929 121
SPD class	TYPE 2 P1
Max. continuous operating voltage (d.c.) (U _c)	48 V
Max. continuous operating voltage (d.c.) pair-pair (PoE) (U _c)	57 V
Nominal current (I _n)	1 A
D1 Lightning impulse current (10/350 μs) per line (I _{imp})	0.5 kA
C2 Total nominal discharge current (8/20 μs) total (I _n)	10 kA
Cut-off frequency (f _c)	250 MHz
Connection (input / output)	RJ45 socket / RJ45 socket
Approvals	CSA, UL, GHMT, EAC

DEHNpatch Class D

Universal arrester for Industrial Ethernet, Power over Ethernet applications according to class D up to 100 MHz. DIN rail mounted adapter with sockets.

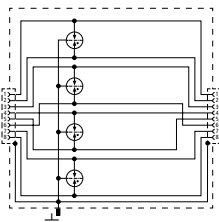

Type DPA ...	M CLD RJ45B 48
Part No.	929 126
SPD class	TYPE 2 P2
Max. continuous operating voltage (d.c.) (U _c)	48 V
Max. continuous operating voltage (d.c.) pair-pair (PoE) (U _c)	57 V
Nominal current (I _n)	1 A
D1 Lightning impulse current (10/350 μs) per line (I _{imp})	0.5 kA
C2 Total nominal discharge current (8/20 μs) total (I _n)	10 kA
Cut-off frequency (f _c)	100 MHz
Connection (input / output)	RJ45 socket / RJ45 socket
Approvals	UL, EAC

Accessories for DEHNpatch DPA CLE IP66

Lightning Protection Pipe Clamp With Tines

Fixing on elements of any cross-section with clamping screw (M8).

Type	BRS 27.168 Z AK1X10 2X6.8 V2A
Part No.	540 200
Clamping range Ø pipe	27-168 mm (3/4-6")
Material (conductor holder)	StSt
Connection Rd	1-2 x 6-8 mm / 1 x 10 mm
Connection (solid / stranded)	4-50 mm ²



Tensioning Strap for Pole Mounting

Fixing on elements of any cross-section with clamping screw (M8).

Type	LH 6.8 SB50.150 SPSM8 V2A
Part No.	200 039
Clamping range Ø pipe	50-150 mm
Material (conductor holder)	StSt



Accessories for DEHNpatch

Mounting Set for DEHNpatch

The set comprises a DIN rail for up to 24 DEHNpatch devices and different distance bolts with sliding nuts for installation in data distributors. To save space, the DIN rail can be mounted at the distributor panel or even upstream of the mounting sections in a 19" grid dimension.

Type	MS DPA
Part No.	929 199
Mounting in	19" cabinets



482.6 mm (19 inch) Universal DIN Rail Carrier

For 19" technology (3 rack units) or wall mounting. DIN rail can be mounted vertically or horizontally.

Type	MF DR 3RU 19"
Part No.	929 335
Dimensions	3 vertical modules
Enclosure material	aluminium/zinc sheet / StSt



Mounting Set DEHNpatch and DEHNgate

DIN rail mounting set for DEHNpatch and DEHNgate. For individual installation of the arresters.

Type	MS EB DPA DGA
Part No.	929 200
Material (earthing clip)	St/gal Zn
Material (flat receptable)	CuZn / Sn
Connection cross-section	0.5-1.5 mm ²



SPDs for Tel. and Data Networks



DEHN protects.

BLITZDUCTOR
BXT ML4 BD
BEX 24

No. 920 381



U_c 33 V_{eff}
 U_M 24 V_{eff}
I_{imp} 0.5 A/100

BLITZDUCTOR
BXT M
BEX 24



No
pro
 U_c
 U_M
I_{imp}

DEHN

SPDs for Building Systems

Description	Type	Product	Part No.	Page
DEHNprotector				
<ul style="list-style-type: none"> – Combined adapter for protecting the power and data side of a terminal device – Different versions for protecting different interfaces – With visual operating state / fault indication 	DPRO 230 TV		909 300	216
	DPRO 230 NT		909 310	217
	DPRO 230 ISDN		 909 320	217
	DPRO 230 LAN100		909 321	217

BUSector				
<ul style="list-style-type: none"> – Surge arrester for protecting KNX / EIB systems – Optimally adapted to KNX / EIB systems – EIBA-approved 	BT 24		925 001	218

DEHNbox				
<ul style="list-style-type: none"> – Compact surge arrester in a surface-mounted plastic enclosure – Powerful protection for telecommunication interfaces at the boundaries from LPZ 0_A to 2 – Suitable for wall mounting IP20 	DBX TC B 180 DBX TC 180		922 220  922 210	220 220

DEHNbox actiVsense				
<ul style="list-style-type: none"> – Wall-mounted universal lightning current and surge arrester – Integrated actiVsense technology – Easy installation and retrofitting 	DBX U4 KT BD S 0-180		922 400	220



DEHNprotector – Combined Adapter



Combined surge protective adapter with visual operating state and fault indication plugged into an earthed socket outlet.

- Combined surge protection for the power and data side of terminal equipment
- Protection of
 - TVs and satellite devices
 - Telephone systems
 - Ethernet components
- Visual operating state / fault indication
- Easy retrofitting

The arresters of the DEHNprotector family are plugged into earthed socket outlets and protect terminal equipment with an additional data interface. Surges are discharged to the PE contact of the socket outlet. The

plug-in fitting simplifies retrofitting with surge protection. The surge protective device for the power side features a visual operating state and fault indication. This underlines the ease of maintenance.



Version with coaxial connection.



Version with RJ connection.



Plug for earthed socket outlets for protecting the power side.



Visual operating state and fault indication of the power side (230 V).

For further surge protective adapters for protecting the power supply of electronic devices please also refer to page 115.

DPRO 230 TV

Combined surge protection for the power and antenna side of TV, radio or satellite receivers. With visual operating state and fault indication and integrated child safety mechanism.



Type DPRO 230 ...	TV
Part No.	909 300
Protection of the data side	
SPD class	TYPE 2
Max. continuous operating voltage (d.c.) (U _c)	60 V
C2 Nominal discharge current (8/20 μs) line-shield (PE) (I _n)	5 kA
Insertion loss 0-2400 MHz	≤ 1.5 dB
Connection (input / output)	F socket / F socket
Protection of the power side	
SPD according to EN 61643-11 / IEC 61643-11	type 3 / class III
Max. continuous operating voltage (a.c.) (U _c)	255 V (50 / 60 Hz)
Total discharge current (8/20 μs) [L+N-PE] (I _{total})	5 kA
Voltage protection level [L-N] (U _p)	≤ 1.25 kV
Max. mains-side overcurrent protection	16 A gL/gG or B 16 A

DPRO 230 NT

Combined surge protection for the power and data side of a digital network termination (NT). Also suited for telephones and fax machines. With visual operating state and fault indication and integrated child safety mechanism.

Type DPRO 230 ...	NT
Part No.	909 310
Protection of the data side	
SPD class	TYPE 2 Pt1
Max. continuous operating voltage (d.c.) (U_c)	180 V
Lightning impulse current (10/350 μ s) per line D1 (I_{imp})	1 kA
C2 Nominal discharge current (8/20 μ s) per line (I_n)	2.5 kA
Cut-off frequency (f_c)	50 MHz
Connection (input / output)	RJ12 socket / RJ12 socket
Protection of the power side	
SPD according to EN 61643-11 / IEC 61643-11	type 3 / class III
Max. continuous operating voltage (a.c.) (U_c)	255 V (50 / 60 Hz)
Total discharge current (8/20 μ s) [L+N-PE] (I_{total})	5 kA
Voltage protection level [L-N] (U_p)	≤ 1.25 kV
Max. mains-side overcurrent protection	B 16 A



DPRO 230 ISDN

Combined surge protection for the power and ISDN S_0 side of ISDN systems and devices. Shielded port makes it suitable for protecting Ethernet 10 BT. With visual operating state and fault indication and integrated child safety mechanism.

Type DPRO 230 ...	ISDN
Part No.	909 320 
Protection of the data side	
SPD class	TYPE 2 Pt1
Max. continuous operating voltage (d.c.) (U_c)	48 V
Lightning impulse current (10/350 μ s) per line D1 (I_{imp})	1 kA
C2 Total nominal discharge current (8/20 μ s) (I_n)	10 kA
Cut-off frequency (f_c)	50 MHz
Connection (input / output)	shielded RJ45 socket / shielded RJ45 socket
Protection of the power side	
SPD according to EN 61643-11 / IEC 61643-11	type 3 / class III
Max. continuous operating voltage (a.c.) (U_c)	255 V (50 / 60 Hz)
Total discharge current (8/20 μ s) [L+N-PE] (I_{total})	5 kA
Voltage protection level [L-N] (U_p)	≤ 1.25 kV
Max. mains-side overcurrent protection	B 16 A



DPRO 230 LAN100

Combined surge protection for the power side and data input for protecting LAN components. Protection of all pairs for Ethernet pin assignment. It meets the requirements for channel class D in accordance with EN 50173 and is thus suitable for 1000 Base-T (Gigabit Ethernet). With visual operating state and fault indication and integrated child safety mechanism.

Type DPRO 230 ...	LAN100
Part No.	909 321
Protection of the data side	
SPD class	TYPE 2 Pt1
Max. continuous operating voltage (d.c.) (U_c)	58 V
Lightning impulse current (10/350 μ s) per line D1 (I_{imp})	1 kA
C2 Total nominal discharge current (8/20 μ s) (I_n)	10 kA
Cut-off frequency (f_c)	120 MHz
Connection (input / output)	shielded RJ45 socket / shielded RJ45 socket
Protection of the power side	
SPD according to EN 61643-11 / IEC 61643-11	type 3 / class III
Max. continuous operating voltage (a.c.) (U_c)	255 V (50 / 60 Hz)
Total discharge current (8/20 μ s) [L+N-PE] (I_{total})	5 kA
Voltage protection level [L-N] (U_p)	≤ 1.25 kV
Max. mains-side overcurrent protection	B 16 A





BUSector



Surge arrester for KNX / EIB buses with connection wires.

- Surge arrester for KNX / EIB buses
- Extremely space-saving due to KNX / EIB bus terminal design
- System-tested with EIBA certification



The discharge capacity, protective effect and mechanical design of BUSector surge arresters are adapted to the installation environment of KNX / EIB buses. Like bus terminals, they can be plugged onto the bus terminal pins of a terminal device connected using the existing connecting

cables. BUSector surge arresters can also be connected to an existing bus terminal on the terminal device. They particularly protect line and area couplers as well as gateways and sensors installed on the outer walls of buildings.

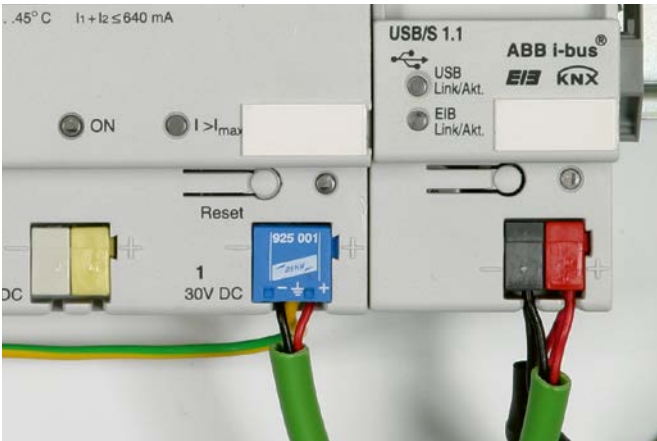

Protection of a KNX power supply unit by means of a BUSector surge arrester mounted in the standard bus terminal slot.



Protection of a KNX bus coupling unit by means of a BUSector surge arrester mounted on a bus terminal in the mounting panel of a cable duct.

BT

Surge arrester with KNX bus terminal design, adapted to the immunity of KNX / EIB systems. EIBA-certified.

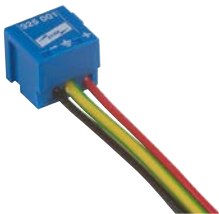

Type	BT 24
Part No.	925 001
SPD class	TYPE 2
Max. continuous operating voltage (d.c.) (U _c)	45 V
Nominal current (I _n)	6 A
D1 Lightning impulse current (10/350 μs) per line	1 kA
C2 Nominal discharge current per line (I _n)	5 kA
Cut-off frequency line-line (f _c)	70 MHz
Approvals	EIBA certification No. Z 32/1399/95, EAC



DEHNbox

- **Combined lightning current and surge arrester**
 - Capable of carrying lightning currents up to 10 kA (10/350 μ s)
 - Low voltage protection level, capable of protecting terminal equipment
 - For installation in conformity with the lightning protection zone concept at the boundaries from $0_A - 2$ and higher
- **Easy to use**
 - Suitable for wall mounting
 - Fast and easy installation due to spring-loaded terminals
 - Easy retrofitting of surge protection
- **Safe installation and operation (DBX TC B 180)**
 - Status indication for easy maintenance
 - RJ45 connection possibility for plug & play
 - Universal use up to 1 Gbit



DEHNbox used for a telecommunication connection (example: U_{k0} interface)

DEHNbox

The compact arresters of the DEHNbox product family are combined lightning current and surge arresters designed for protecting information, measuring and control and automation equipment and systems. With its surface-mounted plastic enclosure with integrated fixing lugs, DEHNbox is ideally suited for wall mounting and can be easily retrofitted into existing equipment and systems. The IP 65 degree of protection allows DEHNbox TC 180 and DBX U4 KT BD S 0-180 to be used in harsh environments such as in moist atmospheres. The cable entries are designed as installation-friendly self-sealing rubber grommets. These grommets allow easy and fast installation and prevent the ingress of moisture and dust. Both the cores and an installed line shield can be contacted via spring-loaded terminals without the need for screws. DEHNbox is available in three versions:

DEHNbox TC B 180

DEHNbox TC B 180 has been specifically developed to meet the latest requirements of telecommunication applications such as VDSL2 vectoring and G.fast (up to 1 Gbit). The main focus of this surge arrester is, in addition to optimum protection of the terminal equipment, on low-attenuation signal transmission and simple handling. Due to the special snap-in cover of the IP 20 enclosure, several arresters can be locked together and screwed to the wall. The telephone line is mounted at the input without tools via push-in terminals. On the output side, the connecting line can be connected to push-in terminals or an RJ45 socket, depending on the application (mounting near the network termination or directly on the router). It is also possible to earth the cable shield directly or indirectly. With a maximum continuous operating voltage of 180 V d.c. and a maximum operating current of 1 A, the DBX TC B 180 can also be universally used in non-telecommunications applications to protect measuring and control interfaces and other applications.



Push-in terminals for fast connection without tools (DBX TC B 180)



RJ45 socket at the output for direct connection to the router (DBX TC B 180).



Visual status display (DBX TC B 180).

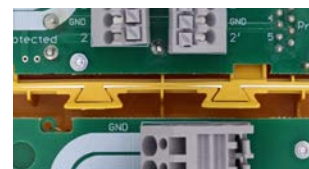

Side-by-side mounting of several devices thanks slide-in dovetail connections on the enclosures (DBX TC B 180).

DEHNbox TC 180

The arrester is optimised for use at telecommunication connections and devices such as analogue telephones as well as ISDN and VDSL2 connections. With a cut-off frequency of 250 MHz, the arrester is also capable of transmitting high-frequency signal parts and can thus be used at high-performance signal interfaces. As an alternative, DEHNbox TC 180 can also be installed at measuring and control interfaces up to a voltage of 180 V and a maximum current of 750 mA.

DEHNbox TC 180 enables the fast connection of one pair without tools and makes it possible to use cable ties to fix the connection cable to the printed circuit board (strain relief). The connection space in the box and the position of the terminals ensure optimal conductor routing and easy conductor connection.

DEHNbox with actiVsense technology

This arrester type does not have a specific nominal voltage and can thus be used for voltages ranging from 0 to 180 V with a superimposed signal voltage (± 5 V/50 MHz). The nominal current is limited to 100 mA which is sufficient for information technology systems. This innovative actiVsense technology allows the arrester to detect the signal voltage applied and to automatically adapt the voltage protection level to this voltage. This makes the arrester ideal for applications where changing or slowly fluctuating signal levels (≤ 400 Hz) are to be expected. In case of interference, DEHNbox arresters have an adapted voltage protection level for every signal voltage, thus providing maximum protection for the devices and system circuits connected to them. The four-pole version of DEHNbox provides protection for two different balanced interfaces, e.g. a bus interface with a system voltage of 5 V and an analogue measured value signal with a system voltage of 24 V. The arrester is ideally suited for domestic and industrial use in information technology transmission systems such as telecommunication, bus and measuring and control systems.

NEW



DBX TC B 180

Compact surge arrester in a surface-mounted plastic enclosure for protecting information technology interfaces, in particular telecommunication connections up to VDSL and G.fast (up to 1 Gbit/s). Connection of one pair without tools and integrated strain relief for the connecting cable. Connection of a pair or a patch cable with RJ45 plug at the output.

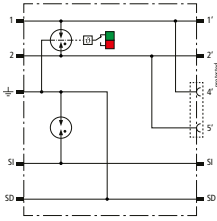

Type DBX ...	TC B 180
Part No.	922 220 <small>NEW</small>
SPD class	TYPE 1P2
Max. continuous operating voltage (d.c.) (U_c)	180 V
D1 Total lightning impulse current (10/350 μ s) (I_{imp})	7.5 kA
C2 Total nominal discharge current (8/20 μ s) (I_n)	20 kA
Series resistance per line	0 ohms
Approvals	EAC

!



DBX TC 180

Compact combined arrester in a surface-mounted plastic enclosure for protecting information technology interfaces, particularly telecommunication connections and devices such as analogue telephones, ISDN and xDSL (VDSL2-tested). Fast connection of one pair without tools and possibility of strain relief for the connecting cable by means of a cable tie (not included in delivery). Cut-off frequency up to 250 MHz ensures maximum transmission performance in case of high-frequency signal parts.

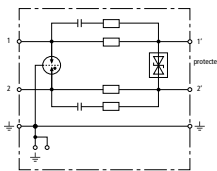

Type DBX ...	TC 180
Part No.	922 210 <small>!</small>
SPD class	TYPE 1P2
Max. continuous operating voltage (d.c.) (U_c)	180 V
Nominal current at 45°C (I_L)	0.75 A
D1 Total lightning impulse current (10/350 μ s) (I_{imp})	7.5 kA
C2 Total nominal discharge current (8/20 μ s) (I_n)	15 kA
Series resistance per line	1.8 ohms
Cut-off frequency line-line (100 ohms) (f_G)	250 MHz
Dimensions (L x W x H)	93 x 93 x 55 mm
Approvals	EAC

DBX U4 KT BD S 0-180

Compact combined lightning current and surge arrester in a surface-mounted plastic enclosure with actiVsense technology for protecting two pairs with the same or a different signal voltage of galvanically isolated balanced interfaces. The actiVsense technology automatically detects the operating voltage and optimally adapts the voltage protection level to it.

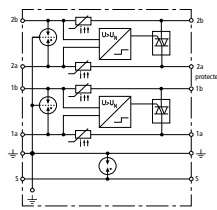



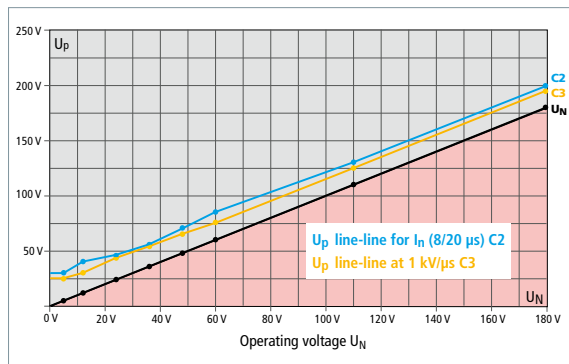



Type DBX ...	U4 KT BD S 0-180
Part No.	922 400
SPD class	TYPE 1P1
Max. continuous operating voltage (d.c.) (U_c)	180 V
Permissible superimposed signal voltage (U_{signal})	$\leq \pm 5$ V
Cut-off frequency line-line (U_{signal} , balanced 100 ohms) (f_G)	50 MHz
Nominal current I_L (equals max. short-circuit current)	100 mA
D1 Total lightning impulse current (10/350 μ s) (I_{imp})	10 kA
C2 Total nominal discharge current (8/20 μ s) (I_n)	20 kA
Series resistance per line	≤ 9 ohms; typically 7.9 ohms
Dimensions (L x W x H)	93 x 93 x 55 mm
Approvals	EAC



Voltage protection level diagram (DBX U4 KT BD S 0-180)

SPDs for Coaxial Connection

Description	Type	Product	Part No.	Page
UGKF BNC				
<ul style="list-style-type: none"> – Easily adaptable – With indirect shield earthing to avoid ground loops – Protection of video cameras 	UGKF BNC		929 010	222
DEHNgate BNC VC				
<ul style="list-style-type: none"> – Easily adaptable – For DIN rail or wall mounting – With direct or indirect shield earthing 	DGA BNC VCD DGA BNC VCID		909 710 909 711	222 222
DEHNgate FF / GF / GFF TV				
<ul style="list-style-type: none"> – Combinable system of lightning current and surge arresters – With F connection for 75-ohm satellite and broadband cable systems – Integrated measuring output 	DGA FF TV DGA GF TV DGA GFF TV		909 703 909 704 909 705	223 223 223
DEHNgate 5X FF TV				
<ul style="list-style-type: none"> – Compact surge arrester for satellite systems – Optimal five-channel protection for 75-ohm antenna splitters and multi-switches – Fulfils the shielding requirements of class A acc. to EN 50083-2 	DGA FF5 TV		909 706	223
DEHNgate G				
<ul style="list-style-type: none"> – Compact dimensions – Wide transmission range – With SMA, BNC or N connection 	DGA G SMA DGA G BNC DGA G N		929 039 929 042 929 044	224 224 224
DEHNgate AG				
<ul style="list-style-type: none"> – Exchangeable gas discharge tube – Long endurance 	DGA AG BNC DGA AG N		929 043 929 045	224 224
DEHNgate LG / L4				
<ul style="list-style-type: none"> – Wide transmission range for multi-frequency applications – Integrated quarterwave technology – With 7/16 or N connection 	DGA LG 7 16 MFA DGA L4 7 16 S DGA L4 7 16 MFA		929 146 929 047 929 148	224 224 224



UGKF



- Plug-in surge protective adapter for easy retrofitting
- Plugs directly into coaxial terminal equipment
- Integrated indirect shield earthing avoids ground loops

Surge arrester designed as a cable adapter for protecting coaxial systems such as video and camera systems from potential damage.

UGKF BNC shielded surge arresters are plugged into coaxial terminal equipment or connections. Common applications include the protection of outdoor video surveillance systems or video control centres. In order to avoid ground loops, the cable shield is earthed indirectly via a gas discharge tube. The arrester entries are sockets and the protected outputs plugs.

Devices for video systems with a higher supply voltage or sockets on both ends are available on request.

We recommend using DGA BNC VC... arresters for easy installation on a DIN rail. These space-saving surge arresters have BNC sockets and protect video and camera systems. Two versions are available: DGA BNC VCD with direct connection of the cable shield to the earth potential or DGA BNC VCID with indirect connection of the cable shield. The arresters are earthed via the DIN rail.



UGKF BNC can be directly plugged into the interfaces of terminal equipment.



UL listing for country-specific use.



DGA BNC VC ... can be easily adapted due to BNC connection.



DGA BNC VC... can be easily mounted on DIN rails or walls.

UGKF BNC

Two-stage surge arrester with indirect shield earthing for protecting video cameras and Arcnet with BNC connection to avoid ground loops.

Type	UGKF BNC
Part No.	929 010
SPD class	TYPE 2 P1
Max. continuous operating voltage (d.c.) (U _c)	8 V
Nominal current (I _n)	0.1 A
C2 Nominal discharge current (8/20 μs) line-shield (I _n)	2.5 kA
Insertion loss at 300 MHz (50 ohms)	≤ 3 dB
Return loss at 40 MHz (50 ohms)	≥ 20 dB
Insertion loss at 265 MHz (75 ohms)	≤ 3 dB
Return loss at 40 MHz (75 ohms)	≥ 20 dB
Approvals	CSA, UL, EAC



DGA BNC VC

The space-saving surge arrester with BNC socket can be mounted on DIN rails for protecting video and camera systems. Available with direct (VCD) or indirect shield connection (VCID) depending on the type to avoid ground loops.

Type DGA ...	BNC VCD	BNC VCID
Part No.	909 710	909 711
SPD class	TYPE 2 P1	TYPE 2 P1
Max. continuous operating voltage (d.c.) (U _c)	6.4 V	6.4 V
Nominal current (I _n)	0.1 A	0.1 A
D1 Lightning impulse current (10/350 μs) (I _{imp})	1 kA	1 kA
C2 Nominal discharge current (8/20 μs) line-shield (I _n)	5 kA	5 kA
Frequency range	0-300 MHz	0-300 MHz
Connection (input / output)	BNC socket / BNC socket	BNC socket / BNC socket
Approvals	CSA, UL	CSA, UL



Ableiter für koaxialen Anschluss



DEHNgate

- Universal surge and combined arresters
- Maximum discharge capacity for coaxial systems
- Low voltage protection level also suitable for protecting terminal equipment
- Extremely durable contact materials



DEHNgate is a family of lightning current / surge arresters designed as cable adapters for protecting coaxial systems such as cell sites and antenna systems from potential damage. The DEHNgate arrester family comes in different mechanical and electrical designs to suit a wide range of applications. The various types and arrester technologies make it possible to provide optimum solutions for a wide range of applications.

The space-saving DG A FF TV can be mounted onto a DIN rail to protect satellite systems with several outputs. For single applications such as broadband cable connections, the device can simply be snapped into a wall-mounted adapter. Two F connections are also included.

The quarter-wave surge arresters are bandpass filters. Only signals within a defined frequency band are transmitted. Since lightning interferences

have a low frequency spectrum, the shorting stub acts as a short-circuit, conducting the lightning current to the ground. This makes the surge arresters mechanically very robust and almost maintenance-free. Due to their low voltage protection level and high discharge capacity, they can be used as combined lightning current and surge arresters. If additional remote supply is needed for the antenna, a combination of a gas discharge tube and quarter-wave technology (DGA LG) should be used. The arresters are made of top-quality materials and offer outstanding endurance.



Surge arrester for satellite and broadband cable systems.



F connection for 75-ohm systems.



Coaxial arrester with exchangeable gas capsule.



Maintenance-free quarter-wave surge arresters for protecting high-frequency applications (e.g. LTE).

DGA TV

DGA ... TV arresters with F connection for remote supply protect 75-ohm satellite and broadband cable systems and fulfil the high shielding requirements of class A according to EN 50083-2. They allow space-saving installation in all common TV and satellite applications and are available as lightning current arresters, surge arresters and combined lightning current and surge arresters with integrated measuring output, a for checking the system.

Type DGA ...	FF TV	GF TV	GFF TV
Part No.	909 703	909 704	909 705
SPD class	TYPE 3PI	TYPE 1	TYPE 1 TYPE 3PI
Max. continuous operating voltage (d.c.) (U _c)	24 V	60 V	24 V
Nominal current (I _n)	2 A	2 A	2 A
D1 Lightning impulse current (10/350 μs) (I _{imp})	0.2 kA	2.5 kA	2.5 kA
C2 Nominal discharge current (8/20 μs) (I _n)	1.5 kA	10 kA	10 kA
Frequency range	d.c. / 5-3000 MHz	0-2400 MHz	d.c. / 5-2400 MHz
Connection (input / output)	F socket / F socket	F socket / F plug	F socket / F socket
Approvals	EAC	EAC	EAC



DGA FF5 TV

Five-channel surge arrester for 75-ohm antenna systems. Special design for SAT antenna splitters and multi-switches. The arrester fulfils the shielding requirements of class A acc. to EN 50083-2.

Fixing material and EB conductor included in delivery.

Type DGA ...	FF5 TV
Part No.	909 706
SPD class	TYPE 2PI
Max. continuous operating voltage (d.c.) (U _c)	20 V
Nominal current (I _n)	0.4 A
D1 Lightning impulse current (10/350 μs) (I _{imp})	0.5 kA
D1 Total lightning impulse current (10/350 μs) (I _{imp})	2.5 kA
C2 Nominal discharge current (8/20 μs) (I _n)	2.5 kA
C2 Total nominal discharge current (8/20 μs) (I _n)	10 kA
Frequency range	47-2200 MHz
Connection (input / output)	F socket / F socket



DGA G

Surge arrester with integrated gas discharge tube. Remote supply possible. SMA, BNC or N connection.



Type DGA ...	G SMA	G BNC	G N
Part No.	929 039	929 042	929 044
SPD class	TYPE 2	TYPE 2	TYPE 2
Max. continuous operating voltage (d.c.) (U _c)	135 V	135 V	135 V
Nominal current (I _n)	2 A	3.5 A	6 A
Max. transmission capacity	60 W	25 W	60 W
D1 Lightning impulse current (10/350 μs) (I _{imp})	1 kA	1 kA	1 kA
C2 Nominal discharge current (8/20 μs) (I _n)	5 kA	5 kA	5 kA
Frequency range	0-5.8 GHz	0-4 GHz	0-5.8 GHz
Connection	SMA socket / SMA plug	BNC socket / BNC plug	N socket / N plug

DGA AG

Lightning current arrester with replaceable gas discharge tube. Remote supply possible. BNC or N connection.



Type DGA ...	AG BNC	AG N
Part No.	929 043	929 045
SPD class	TYPE 1	TYPE 1
Max. continuous operating voltage (d.c.) (U _c)	180 V	180 V
Nominal current (I _n)	3.5 A	6 A
Max. transmission capacity	150 W	150 W
D1 Lightning impulse current (10/350 μs) (I _{imp})	5 kA	5 kA
C2 Nominal discharge current (8/20 μs) (I _n)	20 kA	20 kA
Frequency range	0-1 GHz	0-2.5 GHz
Connection	BNC socket / BNC plug	N socket / N plug

DGA LG

Quarterwave lightning current arrester combined with a spark gap for multi-frequency applications (e.g. LTE). Remote supply possible. 7/16 connection.



Type DGA ...	LG 7 16 MFA
Part No.	929 146
SPD class	TYPE 1
Max. continuous operating voltage (d.c.) (U _c)	65 V
Nominal current (I _n)	13 A
Max. transmission capacity	1500 W
D1 Lightning impulse current (10/350 μs) (I _{imp})	5 kA
C2 Nominal discharge current (8/20 μs) (I _n)	20 kA
Frequency range	690 MHz-2.7 GHz
Connection	7/16 socket / 7/16 plug

DGA L4

Combined lightning current and surge arrester with maintenance-free quarterwave technology and adapted frequency band. No remote supply possible. 7/16 connection.



Type DGA ...	L4 7 16 S	L4 7 16 MFA
Part No.	929 047	929 148
SPD class	TYPE 1 P1	TYPE 1 P1
Max. continuous operating voltage (d.c.) (U _c)	0 V	0 V
Nominal current (I _n)	0 A	0 A
Max. transmission capacity	3000 W	1500 W
D1 Lightning impulse current (10/350 μs) (I _{imp})	25 kA	40 kA
C2 Nominal discharge current (8/20 μs) (I _n)	50 kA	80 kA
Frequency range	380-512 MHz	690 MHz-2.7 GHz
Connection	7/16 socket / 7/16 plug	7/16 socket / 7/16 plug

Ableiter für koaxialen Anschluss

Mounting Set DEHNpatch and DEHNgate

DIN rail mounting set for DEHNpatch and DEHNgate. For individual installation of the arresters.

Type	MS EB DPA DGA
Part No.	929 200
Material (earthing clip)	St/gal Zn
Material (flat receptable)	CuZn / Sn
Connection cross-section	0.5-1.5 mm ²

**Gas Discharge Tube for DEHNgate**

Lightning current carrying replacement gas discharge tube for DEHNgate arresters. High quality with extremely low capacitance.

Type	GDT DGA 90	GDT DGA 230	GDT DGA 470
Part No.	929 497	929 498	929 499
Lightning impulse current carrying capability (10/350 µs)	5 kA	5 kA	5 kA

**Cable Lug with Earthing Conductor**

Cable lug with highly flexible black copper earthing conductor for earthing DEHNgate arresters (Part Nos. 929 043, 929 044 or 929 045).

Type	EL 16 B17
Part No.	929 096
Colour	black ●
Length	1000 mm

**Earthing Block 4xF**

Four-pole earthing block with F sockets for equipotential bonding of satellite cable shields or DGA GF TV lightning current arresters.

Type	EB 4 F
Part No.	929 095
D1 Lightning impulse current (10/350 µs)	10 kA

**Angled Fixing Plate for DEHNgate**

Suitable for installing a DEHNgate arrester (Part Nos. 929 045, 929 146, 929 047, 929 148).

Type	BW90 B11 B5.1 6.5 11 V2A
Part No.	106 310
Material	StSt

**Angled Fixing Plate for DEHNgate**

Suitable for installing a DEHNgate arrester (Part Nos. 929 043 - 929 045), anti-rotation borehole (Ø16 mm).

Type	BW90 B16 B5.1 6.5 11 V2A
Part No.	106 314
Material	StSt

**Angled Fixing Plate for HF Arresters**

With three boreholes for three different sizes of DEHNgate, e.g. 1x 929 042 + 1x 929 057 + 1x (929 043, 929 044, 929 045 or 929 059).

Type	BW90 B17 21 16 V2A
Part No.	106 329
Material	StSt

**Equipotential Bonding Busbar for industrial Use**

Suitable for 3x DEHNgate (Part Nos. 929 045, 929 047, 929 146, 929 148).

Type	PAS I 6AP M10 V2A
Part No.	472 209
Material	StSt

**Earthing Conductor, open / closed Cable Lugs**

Cable lug 1x open (M8/M10) and 1x closed (M8), can be combined with Part Nos. 106 310, 106 314, 106 329 and 472 209.

Type	EL16 L1.05M 1KSO 8.10 1KSG 8
Part No.	416 411
Colour	black ●
Length	1050 mm





DEHN protects.

BLITZDUCTOR
BXT ML4 BD
BEX 24

No. 920 381

U_c 33 V_{eff}
 U_M 24 V_{eff}
 I_{imp} 0.5 A/100

BLITZDUCTOR
BXT M
BEX 24

No.
pro
 U_c
 U_M
 I_{imp}
 I_{imp}

DEHN



FS

- Surge arrester with SUB-D connection for easy retrofitting
- 9-pole standard connection
- Standard Profibus-DP or V-24 interface



Surge arrester with D-SUB connection (pin / socket version).



SUB-D connection for easy installation.



Direct connection to the device ensures optimal protection.

The surge arresters are available in a shielded enclosure with SUB-D connection (pin / socket version). The UNC threaded screws of the FS surge arresters for protecting terminal equipment can be exchanged as required. The thread is thus situated either on the pin or socket side, depending on the application.

FS 9E PB

Surge arrester for Profibus-DP. 9-pin SUB-D version, pin 6 unprotected for the programming interface.

Type	FS 9E PB 6
Part No.	924 017
SPD class	TYPE 4P1
Max. continuous operating voltage (d.c.) (U _C)	7 V
C1 Nominal discharge current (8/20 μs) line-line (I _n)	0.2 kA
C1 Nominal discharge current (8/20 μs) line-SG (I _n)	0.2 kA
C1 Nominal discharge current (8/20 μs) SG-PG (I _n)	0.4 kA
Cut-off frequency (f _G)	90 MHz
Connection (input / output)	SUB-D 9 plug / SUB-D 9 socket
Approvals	EAC

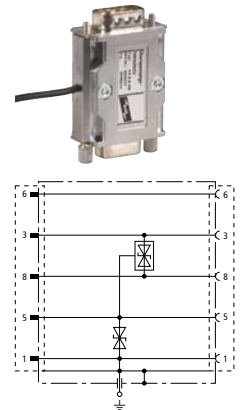



DEHN protects.

Shield Connection Systems and Enclosures

Description	Type	Product	Part No.	Page
Shield connection on anchor bars				
<ul style="list-style-type: none"> – Shield terminals for earthing cable shields on anchor bars – Different versions for different cable diameters – Lightning current carrying system 	SAK ... AS V4A		308 403 – 308 408	231
<ul style="list-style-type: none"> – Mounting rail for earthing and fixing shield terminals – Can be cut to length according to requirements 	AS SAK 1000 V2A		308 421	231
Shield connection on DIN rails				
<ul style="list-style-type: none"> – Shield terminals for earthing cable shields on DIN rails – Different versions for different cable diameters – Lightning current carrying system 	SAK 6.5 SN MS SAK 11 SN MS		919 010 919 011	232 232
<ul style="list-style-type: none"> – DIN rail mounted rail support – Low-impedance connection of the shield terminals to the DIN rail via the busbar 	SH1 18X3 ST SH2 18X3 ST		919 012 ! 919 013	232 232
<ul style="list-style-type: none"> – Busbar for shield terminals – Can be mounted onto busbar supports – Can be cut to length according to requirements 	SN 18X3 CU 1000		919 016	232
Shield connection for cables				
<ul style="list-style-type: none"> – Constant force spring for solderless shield connection for equipotential bonding – Different versions for different cable diameters – Lightning current carrying system 	SA KRF ... V2A		919 031 – 919 038	233
Enclosure				
<ul style="list-style-type: none"> – Aluminium enclosure for DIN rail mounted devices – IP 65 degree of protection – Version for arresters for use in intrinsically safe measuring circuits Ex (i) 	ALGA 5 ALGA 5X		906 055 906 058	234 234

Shield Connection on Anchor Bars



Lightning current carrying shield connection system for anchor bars. A slipping spring element compensates the yield of the cable materials used.

The lightning-current-tested shield connection system is specifically used on anchor bars. As, in the course of time, the cable materials are subject to a yield, this yield is compensated by a slipping spring element. The shield connection can also be isolated from local potential by means of an adequate insulating element.

This extremely robust shield connection system is ideally suited for cables with medium-sized diameters. It is lightning current tested and approved for nuclear plants.

- Lightning-impulse-current-tested up to 10 kA (10/350 μ s)
- Corrosion-resistant stainless steel
- Spring element ensures permanent shield connection



Shield connection system on an anchor bar

Shield Terminals

Shield terminals for earthing cable shields on anchor bars. Suitable for lightning equipotential bonding. Can be subsequently installed without interrupting the cable shield or requiring tools for installation.

General technical data:			
Lightning impulse current carrying capability (10/350 µs)	10 kA		
Material	StSt		
For mounting on	anchor bars		
Type	SAK 10 AS V4A	SAK 14 AS V4A	SAK 18 AS V4A
Part No.	308 403	308 404	308 405
Clamping range (Rd)	5-10 mm	8-14 mm	13-18 mm
Dimensions (W x L x H)	16 x 40 x 48 mm	19.5 x 40 x 50 mm	24 x 40 x 56 mm
Type	SAK 21 AS V4A	SAK 26 AS V4A	SAK 33 AS V4A
Part No.	308 406	308 407	308 408
Clamping range (Rd)	17-21 mm	19-26 mm	25-33 mm
Dimensions (W x L x H)	29 x 40 x 59 mm	36.5 x 40 x 74 mm	45 x 40 x 82 mm



Anchor Bar

Mounting rail for earthing and fixing shield terminals.

Type	AS SAK 1000 V2A
Part No.	308 421
Material	StSt
Dimensions (W x L x H)	29 x 1000 x 15 mm



Insulated Busbar Support

Insulated busbar support for fixing AS SAK 1000 V2A anchor bars, with M4 threaded bushing.

Type	ST AS SAK K
Part No.	308 425
Material	plastic



Terminal

For connecting equipotential bonding conductors to AS SAK 1000 V2A anchor bars.

Type	AK 16 AS SAK MS
Part No.	308 411
Cross-sectional area, solid	16 mm ²
For mounting on	anchor bars



Shield Connection on DIN Rails

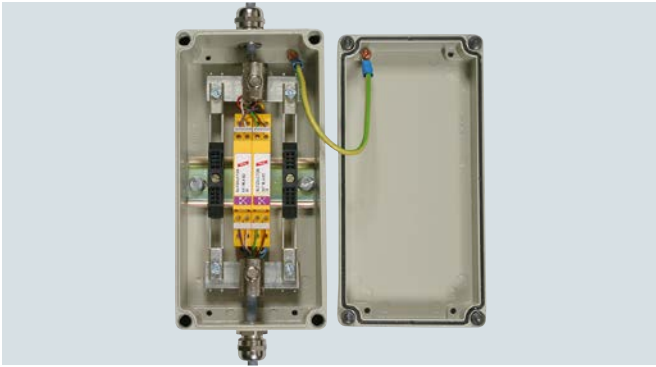

Lightning current carrying DIN rail mounted shield connection system, ideally suited for small cables. Slipping spring element compensates the yield of the cable materials.

- Lightning-impulse-current-tested up to 5 kA (10/350 μs)
- Corrosion-resistant stainless steel
- Spring element ensures permanent shield connection

The lightning-current-tested DIN rail mounted shield connection system for a wide range of applications is ideally suited for small cable diameters such as bus cables. As, in the course of time, the conductor materials are subject to a yield, this is compensated by a slipping spring element. The shield connection can also be isolated from local potential by means of an adequate insulating element.



Shield Terminals

For DIN rails.

Type	SAK 6.5 SN MS	SAK 11 SN MS
Part No.	919 010	919 011
Lightning impulse current carrying capability (10/350 μs)	5 kA	5 kA
Clamping range (Rd)	1.5-6.5 mm	5-11 mm
Material	nickel-plated brass	nickel-plated brass
For mounting on	SN 18x3 CU 1000	SN 18x3 CU 1000
Dimensions (W x L x H)	10 x 25 x 40 mm	17 x 25 x 47 mm



Busbar

Mounting rail for shield terminals. Can be mounted onto busbar supports.

Type	SN 18X3 CU 1000
Part No.	919 016
Material	tin-plated copper
For mounting on	busbar supports
Dimensions (W x L x H)	18 x 1000 x 3 mm



Rail Support with One-sided / Two-sided Contact

Rail support suitable for DIN rail mounting. Low-impedance connection of the shield terminals to the DIN rail via the busbar.

Type	SH1 18X3 ST	SH2 18X3 ST
Part No.	919 012	919 013
Version	one-sided contact	two-sided contact
Material	tin-plated steel	tin-plated steel
For mounting on	35 mm DIN rails acc. to EN 60715	35 mm DIN rails acc. to EN 60715

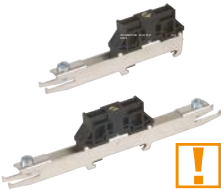

Insulated Rail Support

Insulated rail support for DIN rail mounting or screw connection.

Type	SH 18X3 K
Part No.	919 014
Material	plastic
Colour	black ●
For mounting on	DIN rails or mounting plates



Terminal

Particularly suited for indirect shield earthing.

Type	AK 35 SN 18X3 GG
Part No.	919 015
Cross-sectional area	35 mm ²
For mounting on	busbars

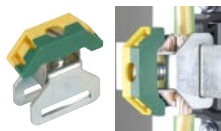



Shield Connection for Cables

- Lightning-impulse-current-tested up to 10 kA (10/350 μ s)
- Extremely space-saving
- Spring element ensures permanent shield connection

The shields of the incoming information and power supply lines can be contacted by means of SA KRF constant force springs in a space-saving and lightning current carrying way. As, in the course of time, the conductor materials are subject to a yield, this yield is compensated by a spring element. To permanently protect the clamping point from corrosion, it is wrapped with a self-bonding SKB rubber tape.

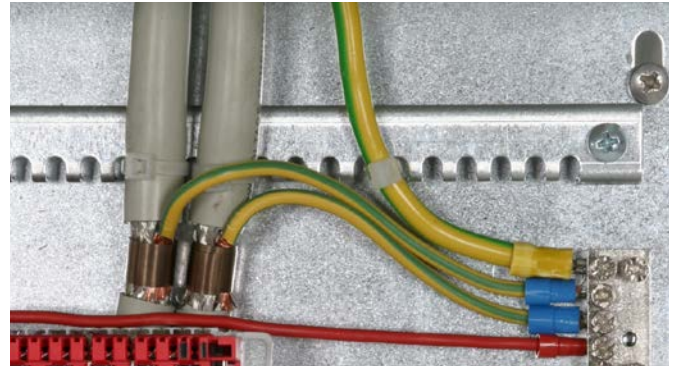

Extremely space-saving shield connection system for use as constant force spring. A spring element compensates the yield of the cable materials.

Constant Force Spring

Constant force springs allow solderless shield connections for equipotential bonding or lightning equipotential bonding. They can be installed subsequently without interrupting the cable shield or requiring tools for installation.

General technical data:				
Lightning impulse current carrying capability (10/350 μ s)	10 kA			
Colour	bare surface			
For mounting on	cable shields			
Type	SA KRF 10 V2A	SA KRF 15 V2A	SA KRF 22 V2A	SA KRF 29 V2A
Part No.	919 031	919 032	919 033	919 034
Clamping range (Rd)	4-10 mm	9-15 mm	14-22 mm	18.5-29 mm
Type	SA KRF 37 V2A	SA KRF 50 V2A	SA KRF 70 V2A	SA KRF 94 V2A
Part No.	919 035	919 036	919 037	919 038
Clamping range (Rd)	23.5-37 mm	31-50 mm	44-70 mm	58-94 mm



Self-bonding Rubber Tape

Roll with 9 m self-bonding rubber tape to be wrapped around constant force springs for permanent corrosion protection.

Type	SKB 19 9M SW
Part No.	919 030
Colour	black ●
Tape dimensions (W x L)	19 mm x 9 m



Enclosure and Protective Conductor Terminal

- High-quality accessories
- Suitable for DIN rail mounted arresters

**Aluminium Enclosure**

For the installation of DIN rail mounted devices. With two M20 brass glands.

Type	ALGA 5
Part No.	906 055
Degree of protection	IP 65
For mounting on	walls
Dimensions (W x H x D)	100 x 200 x 81 mm
Enclosure material	Al

Aluminium Enclosure for Ex(i) Surge Arresters

With 4 plastic glands M20 x 1.5, sealable, pressure compensating grommets.



Type	ALGA 5 X
Part No.	906 058
Degree of protection	IP 65
For mounting on	walls
Dimensions (W x H x D)	160 x 100 x 85 mm
Enclosure material	Al









Protective Conductor Terminal

For earthing DIN rails.



Type	SLK 16
Part No.	910 099
Cross-sectional area, flexible	6-16 mm ²
Cross-sectional area, solid	6-25 mm ²
For mounting on	DIN rails acc. to EN 60715
Enclosure material	polyamide 6.6

Measuring and Test Devices

Description	Type	Product	Part No.	Page
Condition Monitoring System LifeCheck for BLITZDUCTORconnect				
<ul style="list-style-type: none"> – Condition monitoring of BLITZDUCTORconnect arresters with integrated LifeCheck – Fast and easy installation and initial operation (no addressing of arresters) – Remote signalling via floating remote signalling contact (nc) 	DRC IRCM		910 710	236
Condition Monitoring System with RFID LifeCheck				
<ul style="list-style-type: none"> – Condition monitoring of BLITZDUCTOR XT arresters with RFID LifeCheck – Monitoring of up to 10 BXT via a DRC MCM XT and networking of up to 15 DRC MCM XT – Remote signalling via remote signalling contact (no/nc) or optional RS485 interface 	DRC MCM XT		910 695	238
<ul style="list-style-type: none"> – Condition monitoring of BLITZDUCTOR XT arresters with RFID LifeCheck – Monitoring of up to 10 BXT – Remote signalling via remote signalling contact (nc) 	DRC SCM XT		910 696	238
DEHNrecord Alert				
<ul style="list-style-type: none"> – Communication of the arrester status via Modbus TCP/RTU – Monitoring of up to 4 arresters (e.g. Red/Line) via remote signalling contact and up to 150 BLITZDUCTOR XT arresters – Integration of the remote signalling contacts of further functional modules in the monitoring system 	DRC AL MODBUS		910 694	237
<ul style="list-style-type: none"> – Condition monitoring of BLITZDUCTOR XT arresters with RFID LifeCheck – Monitoring of up to 10 BXT via a DRC MCM AL XT and networking of up to 15 DRC MCM AL XT – Communication of the arrester status to a higher-level control system via DRC AL MODBUS 	DRC MCM AL XT		910 698	237
RFID LifeCheck SPD Test Devices				
<ul style="list-style-type: none"> – Portable arrester test device for preventive maintenance of BLITZDUCTOR XT modules – Possibility of addressing and resetting BLITZDUCTOR XT modules for monitoring via DRC MCM/SCM XT – Interface and software for database-based testing and documentation 	DRC LC M3+		910 653	241
<ul style="list-style-type: none"> – Portable arrester test device for preventive maintenance of BLITZDUCTOR XT modules – Fast and easy testing of arresters with RFID LifeCheck – Simple and intuitive operations 	DRC LC M1+		910 655	241
SPD Test Device				
<ul style="list-style-type: none"> – Combined device for testing the sparkover voltage of surge arresters – Preventive testing of Red/Line and Yellow/Line arresters – Suitable for routine testing of surge protective devices 	PM 20		910 511	242



Condition Monitoring System LifeCheck for BLITZDUCTORconnect



- **Two-part monitoring unit in a compact enclosure**
 - Minimum wiring effort thanks to combined transmitter/receiver unit
 - Quick and convenient commissioning
 - Optical reverse unit at the end of the monitoring group
 - Simple line connection thanks to push-in connection technology
- **Maximum protection for high availability of plants and systems**
 - Condition monitoring of arresters of the BLITZDUCTORconnect series
 - Simple visual monitoring principle
 - Resistant to extraneous light
 - Integrated group display and remote signalling contact (break contact)
 - Quick and easy commissioning

NEW

Sample application: BLITZDUCTORconnect with remote signalling unit ensures availability of measuring and control systems

The arresters of the BLITZDUCTORconnect series are equipped with an integrated mechanical status indicator which clearly indicates the condition of the arrester (green/red indicator flag). When an arrester overloads, it is clearly identifiable in the group thanks to the red indicator flag. As the module is simple to replace without the need for tools, system protection is quickly restored.

Arrester groups are permanently monitored by a built-in remote signalling unit. This consists of two compact DIN rail-mounted devices for monitoring arresters which have an integrated passive LifeCheck function. During the test interval, an infrared light beam is emitted by the active transmitter/receiver unit. This light beam is returned by the reverse unit and must be correctly identified by the transmitter/receiver unit. The system is thus resistant to all kinds of extraneous light – at the same time, operational safety is increased.

The maximum distance between the active transmitter/receiver unit and passive reverse unit is 300 mm. This means that up to 50 arresters of the

BLITZDUCTORconnect series with a width of 6 mm can be permanently monitored. An overloaded arrester is detected by interruption of the light beam and is signalled to a higher-level control system by means of an integrated, floating remote signalling contact (break contact).

The active unit features vibration-proof push-in terminals. For connection, stripped solid and flexible conductors with wire end ferrules can be clamped and contacted quickly and easily without using tools. When re-wiring, the conductor is freed from the clamping point by pressing the release button and re-clamped into the appropriate terminal. The combination of transmitter and receiver unit in a single device minimises the wiring effort during installation. At the same time, additional parameterisation of the modules is no longer necessary, which saves time and eases initial operation.

A 24 V power supply unit for supplying the remote signalling unit is available as an optional accessory.

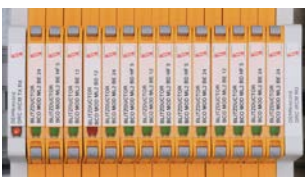

Quickly checked – at a glance
Status indication (group display) for simple and quick maintenance



Quick and convenient
Simple installation/initial operation with combined transmitter/receiver unit

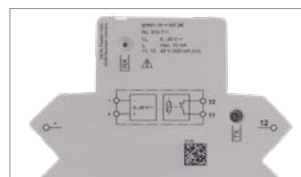

Simple maintenance
Remote signalling of the status of arrester groups (break contact)



Maximum system availability
Approval for use in hazardous areas

NEW



DRC IRCM

Condition monitoring unit DEHNrecord, set for DIN rail mounted devices with integrated visual transmitter/receiver and visual reverse unit for monitoring the condition of BLITZDUCTORconnect arresters with LifeCheck. Visual status indication via LED group display in combination with remote signalling contact (break contact).

Type	DRC IRCM
Part No.	910 710 <small>NEW</small>
Input voltage range (d.c.) (U_N)	6-35 V d.c.
Max. rated current consumption (I_N)	≤ 10 mA
Operating temperature range (T_U)	-30 °C ... +70 °C
Approvals	UL, ATEX, IECEx



Condition Monitoring System RFID LifeCheck

- Permanent condition monitoring of arresters with RFID LifeCheck technology ensures a maximum degree of system protection and availability
- The early detection system even detects pre-damaged arresters and warns of imminent arrester failure
 - Visual indication of faulty or pre-damaged arresters
 - Compact dimensions and minimum wiring effort
 - Monitoring of up to ten arresters (40 signal cores)
 - Remote signalling contact
 - Remote monitoring also via RS485 interface and PC software (DRC MCM XT)

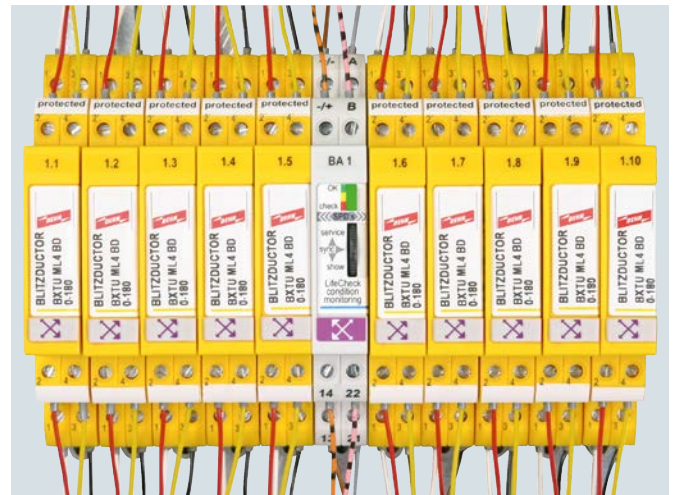

Installed DEHNrecord condition monitoring system

Condition monitoring

The DRC MCM XT and DRC SCM XT condition monitoring systems are compact DIN rail mounted devices designed for condition monitoring of up to 10 pre-programmed BXT/BXTU arresters with an integrated RFID LifeCheck monitoring circuit.

Integrated into the protection modules, RFID LifeCheck permanently monitors the condition of the arrester and acts like an early warning system, detecting imminent electrical or thermal overload of the protection components. The LifeCheck status can be read via non-contact RFID technology. When installed as a stationary unit, a single condition monitoring unit supports the condition-based maintenance of 10 BXT/BXTU arresters.

Like an early warning system, the unit generates a fault message as soon as an arrester overload becomes imminent, indicates this with the integrated three-colour LED and transmits it via the integrated telecommunication contact (FM). Failure of the monitoring unit, e.g. due to a voltage breakdown, is also indicated via the remote signalling contact.

The show function integrated in the DRC MCM XT and DRC SCM XT system makes it possible to detect pre-damaged arresters in the monitoring group.

The DRC SCM XT device is ideally suited for small installations in which up to 10 protection modules can be monitored with the integrated RFID LifeCheck. In case of larger installations with more than 10 arresters, the appropriate device is the DRC MCM XT with an integrated RS485 interface. The condition monitoring units are connected via the integrated RS485 interfaces to synchronise the monitoring cycles. Up to 15 DRC MCM systems can be connected to one another at the RS485 bus, allowing up to 150 BLITZDUCTOR modules or 300 pairs to be monitored simultaneously with minimum wiring effort.

The "Status Display and Service Console" PC software

is optionally available for the DRC MCM XT condition monitoring system. It indicates the status of the arresters and addresses the BLITZDUCTOR modules with RFID LifeCheck technology.

The software can be installed on a standard PC using an RS485/USB interface converter of type "USBNANO 485" which is available as an accessory.

The software can be downloaded free of charge on www.dehn-international.com (service section) or can be requested there on CD for a nominal fee.



Integrated visual operating state indication with three-colour LED.

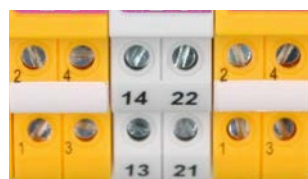

Floating remote signalling contact
DRC MCM XT: break contact (21/22),
make contact (13/14)
DRC SCM XT: break contact (21/22)



RS485 interface A/B (only for DRC MCM XT) for communication and control room solutions.

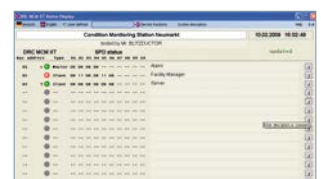

Online monitoring via free software (only for DRC MCM XT).

DRC MCM XT

DIN rail mounted device with integrated RFID LifeCheck sensor for condition monitoring of max. 10 BLITZDUCTOR XT/XTU arresters with RFID LifeCheck technology. Visual operating state indication via three-coloured LED in conjunction with remote signalling contact (break or make contact). Up to 15 DRC MCM XT can be monitored via the integrated RS485 interface in a system with up to 150 BLITZDUCTOR XT/XTU arresters. The free "Status Display and Service Console" software can be optionally used via an RS485 interface converter. The software allows PC-based remote indication of the condition of all monitored arresters.

Download: www.dehn-international.com (Service section)

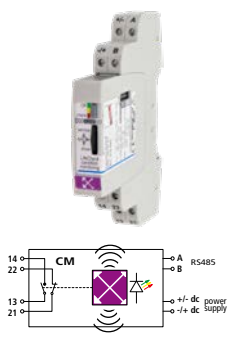

Type DRC ...	MCM XT
Part No.	910 695
Input voltage range (d.c.) (U_{IN})	18-48 V
Max. rated current consumption (I_{IN})	100 mA
RFID transmission frequency	125 kHz
Type of remote signalling contact	make (no) and break contact (nc)
Delivery includes	base part, monitoring module, quick guide and labelling system

DRC SCM XT

DIN rail mounted device with integrated RFID LifeCheck sensor for condition monitoring of up to ten BLITZDUCTOR XT/XTU arresters with RFID LifeCheck technology. Visual operating state indication via three-colour LED combined with remote signalling function (break contact).

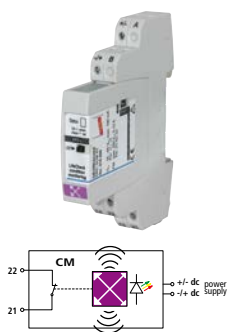

Type DRC ...	SCM XT
Part No.	910 696
Input voltage range (d.c.) (U_{IN})	18-48 V
Max. rated current consumption (I_{IN})	100 mA
RFID transmission frequency	125 kHz
Type of remote signalling contact	break contact (nc)
Delivery includes	base part, monitoring module, quick guide and labelling system

Accessories for Condition Monitoring System RFID LifeCheck

DIN Rail mounted Power Supply Unit

High-performance DIN rail mounted power supply unit with single-phase wide-range input can be connected to different supply systems. The operating state indicator on the front panel indicates whether the output voltage is present. Supply of stationary condition monitoring devices of the DEHNrecord portfolio (DRC SCM XT / DRC MCM XT / DRC IRCM).



Type	PSU DC24 30W
Part No.	910 499
Input voltage range	AC 85-264 V; DC 120-373 V
Frequency	44-66 Hz; 0 Hz
Input current (I_e)	0.7 A at AC 110 V / 0.5 A at AC 230 V
Output nominal voltage (U_a)	DC 24 V (SELV)
Output current (I_a)	1.3 A at DC 24 V, max. 0.9 A at any installation position
Recommended backup fuse	circuit breaker 10 A, 16 A, characteristic B, C
Standards / regulations	EN 60950, EN 61204-3, UL 60950, UL 508, GL

USB Interface Converter of Type USB NANO 485

USB Nano 485 converts between USB and RS485 signals and is specifically designed for two-wire RS-485 buses. LEDs indicate the operating state (yellow), Rx (green) and Tx (red). Due to its compact dimensions, USB Nano 485 is ideally suited for use with notebooks, however, stationary use is also possible.



Type	USB NANO 485
Part No.	910 486
Version	with LED indication

Labelling System BA1-BA15

2x 165 adhesive labels for labelling DRC MCM XT monitoring devices with the bus address.

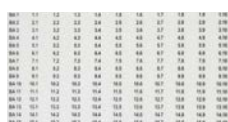

Type	BS BA1 BA15 BXT
Part No.	920 398
Colour	transparent

Partition

Allows BXT devices for non-intrinsically safe circuits to be positioned directly next to intrinsically safe circuits (thread measure ≥ 50 mm). For DRC MCM XT and DRC SCM XT; 1 set = 2 pieces.



Type	TW DRC MCM EX
Part No.	910 697
Colour	blue
For mounting on	35 mm DIN rails acc. to EN 60715



DEHNrecord Alert

- Modbus TCP / RTU communication module
- Integration of Red/Line and Yellow/Line SPDs in a monitoring system
- Monitoring of up to 4 surge arresters with remote signalling contacts and up to 150 BLITZDUCTOR XT arresters (RS 485)
- Integration of the remote signalling contacts of further user-defined functional modules in the monitoring system



DEHNrecord Alert MODBUS

The DEHNrecord Alert is a communication module that integrates surge arresters for use in information and low-voltage systems in detection systems. These systems can communicate via a serial (Modbus RTU) as well as an Ethernet-based (Modbus TCP) interface. In the case of arresters for use in low-voltage systems, the integrated floating remote signalling contacts are detected. Modules from the BLITZDUCTOR XT series are monitored via the DRC MCM AL XT, which also transmits the information collected to the DRC AL via an RS 485 interface. In the case of Red/Line and Yellow/Line devices, in addition to the status of the SPDs, the part number of the complete device and the part numbers of the respective replacement modules are also transmitted. By forwarding the relevant data to the customer's monitoring system, maintenance of the system can be planned directly at the work station. This makes maintenance and service work more efficient and cost-effective, since it is clear which products need to be replaced as soon as the notification is evaluated. The

DEHNrecord Alert automatically recognises all integrated BLITZDUCTOR XT modules and their information. A start-up app is required to integrate the SPDs with integrated remote signalling contact. This intuitive app transmits the device information of the connected SPDs via wireless communication to the DEHNrecord Alert. Optionally, the remote signalling contacts of any other functional modules can be connected. In this case, only the status of the respective remote signalling contacts is transmitted. The module with a width of 1 DIN module is mounted directly on a DIN rail in the switchgear cabinet.

Versions with further bus protocols can be provided on request.

DEHNrecord DRC MCM AL XT

DRC MCM AL XT is a compact DIN rail mounted device for monitoring the status of up to 10 surge arresters of the BXT/BXTU series with integrated LifeCheck. In case of larger installations with more than 10 arresters, up to 15 DRC MCM AL XT can be interconnected by means of the integrated RS 485 interface. Thus, up to 150 protection modules can be monitored simultaneously and the device status can be transmitted to a recording system by a single DEHNrecord Alert.

DRC MCM AL XT is a special version of the DRC MCM XT. With the DRC MCM AL XT it is possible to read and transmit not only the bus address of the BLITZDUCTOR XT but also its part number. Reading the part number is only possible in connection with DEHNrecord Alert. The protection modules are addressed directly using the monitoring module or via the "Status Display and Service Console" software on a PC. DEHNrecord Alert can be used with already installed DRC MCM XT after performing a software update.

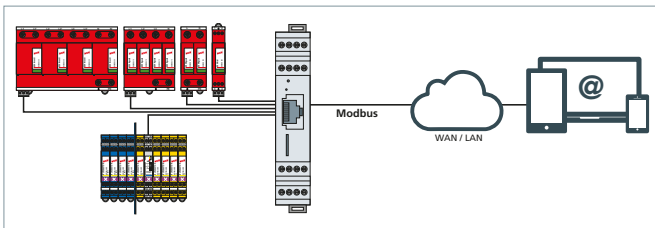

Configuration of the whole DEHNrecord Alert system with Red/Line and Yellow/Line surge arresters.

DRC AL MODBUS

Compact DIN rail mounted device for the transmission of SPD status information, e.g. functional status, part number of SPD and part numbers of the replacement modules via Modbus RTU/TCP.

Type DRC ...	AL MODBUS
Part No.	910 694
Input voltage range (d.c.) (U _{IN})	11-28 V
Max. power	600 mW
Inputs	4 universally applicable remote signalling contacts and up to 150 BLITZDUCTOR XT via DRC MCM AL XT (910 698)
Communication	Modbus RTU/TCP



DRC MCM AL XT

DIN rail mounted device with integrated LifeCheck sensor for condition monitoring of max. 10 LifeCheck-equipped BLITZDUCTOR XT/XTU arresters. Transmission of the status of the bus address and BXT part numbers to the DEHNrecord Alert communication unit.

Type DRC ...	MCM AL XT
Part No.	910 698
Input voltage range (d.c.) (U _{IN})	18-48 V
Max. rated current consumption (I _{IN})	100 mA
RFID transmission frequency	125 kHz
Physical interface	RS 485
Delivery includes	base part, monitoring module, quick guide and labelling system

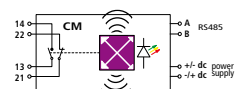



RFID LifeCheck SPD Test Devices



- **SPD test device for preventive maintenance**
 - The RFID LifeCheck monitoring device detects thermal or electrical overload conditions of all components
 - To avoid imminent failure and thus system downtime, the protection module should be replaced as soon as possible
- **Benefits of this type of SPD testing:**
 - Extremely easy and within a matter of seconds
 - Detection of thermal or electrical pre-damage of all components

Periodic inspection of installed arresters

During operation, an arrester may be overloaded by discharge processes that are outside the device specification. To ensure high system availability, it is therefore important to subject arresters to regular tests. Maintenance tests and test intervals for lightning protection systems are specified in DIN EN 62305-3, supplement 3 (see table excerpt). However, these periods are only standard-based minimum requirements.

Class of SPD	Visual inspection	Complete inspection	Complete inspection of critical systems
I and II	1 year	2 years	1 year
III and IV	2 years	4 years	1 year

Visual inspections of arresters for information technology systems do not make sense since the status of the devices is not generally visible. For this purpose, another method has to be chosen as is the case with complete inspections. In the past, measurement equipment was used to test arresters. These measurements were very time consuming, required expertise and did not provide sufficient information.

Notification before the arrester fails

The three-stage LifeCheck monitoring circuit with early warning function detects all protection elements of an arrester. It detects extreme electrical or thermal load below their destruction limit. This can be read out in seconds and without contact using a reader with RFID technology. If the reader determines "LifeCheck OK", no extreme load was detected. In the opposite case, the module should be replaced as soon as possible in order not to jeopardise the availability of the protected circuit.

Simplified check by LifeCheck

BLITZDUCTOR XT with integrated LifeCheck is particularly easy to maintain. LifeCheck uses modern RFID (radio frequency identification) technology for monitoring the protective circuit and for communication. Regardless of system downtimes, LifeCheck allows quick and easy testing of the arrester by means of the portable DRC LC M1+ and DRC LC M3+ test units or stationary DRC SCM XT and DRC MCM XT condition monitoring unit.

Mode of operation of the LifeCheck diagnostic system

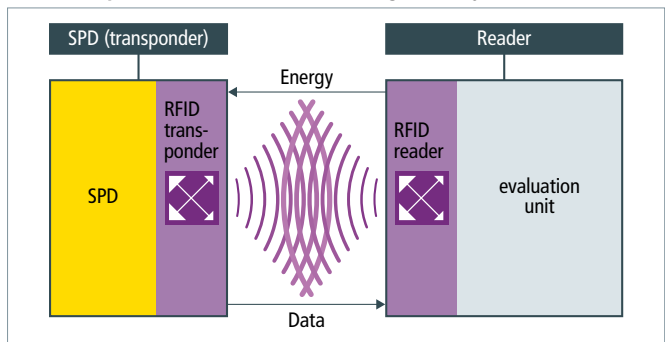

Communication principle between SPD and test device

Information is read via a hand-held tester which houses the RFID reader. It contactlessly transmits electromagnetic energy to the transponder in the SPD, reads out its status and displays it. Information is simple: "SPD OK" or "Replace SPD!". A test can be conducted in a matter of seconds. When testing, the arrester must simply be pulled out of the base part by its mechanical length (approx. 50 mm). When using the BXT BAS, signal availability is also guaranteed while testing.

This type of monitoring reliably detects thermal and electrical overload of all components, typically before the arrester fails and limits the availability of the system to be protected. In addition, no expertise is required for testing. The reader also facilitates documentation of the test results which is mandatory to comply with the EN 62305-3 standard.

The test data (date, time, results) of all arresters are saved and can be transmitted to a PC via a USB interface for printing or storage. Consequently, a higher degree of protection and availability is achieved by means of LifeCheck-based preventive maintenance since overload of components is detected even before the protection of the system circuit fails.



Intuitive operation and fast arrester testing (M1+).



Hand-held snap-on sensor



Interval testing with DRC LC M3+.

Test 01		
Status	Uhrzeit letzte Prüfung	Datum letzte Prüfung
*ok	11:41:34	26.08.15
*ok	11:41:54	26.08.15
*ok	11:42:12	26.08.15
*ok	11:42:32	26.08.15
*ok	11:42:54	26.08.15
*ok	11:43:10	26.08.15
*ok	11:43:29	26.08.15
*ok	11:43:50	26.08.15
*ok	11:44:08	26.08.15

Database function of DRC LC M3+.

Measuring and Test Devices

DRC LC M3+

Portable device with LifeCheck sensor for flexible use. Fast and easy testing of LifeCheck-equipped arresters. Visual and acoustic indication. With additional USB connection and database software for PC-aided management of test samples and documentation of the test results. DRC LC M3+ features a snap-on LifeCheck sensor. The hand-held device allows parameterisation of arresters for condition monitoring.

Type DRC LC ...	M3+
Part No.	910 653
Voltage supply (included in delivery)	lithium-ion battery
RFID transmission frequency	125 kHz
Measured value indication	beep and LCD
Delivery includes	hand-held device, BXT LifeCheck sensor, battery charger, USB cable, test module for reference, software CD, storage case
Dimensions of the storage case	340 x 275 x 83 mm



DRC LC M1+

Portable device with LifeCheck sensor for flexible use. Fast and easy testing of LifeCheck-equipped arresters. The result of the LifeCheck test, the operating state of the device and the battery status are indicated via LEDs. DRC LC M1+ features a snap-on LifeCheck sensor.

Type DRC LC ...	M1+
Part No.	910 655
Voltage supply (included in delivery)	lithium-polymer battery
RFID transmission frequency	125 kHz
Measured value indication	LED
Delivery includes	hand-held device, BXT LifeCheck sensor, power supply unit with country-specific adapters, USB cable, test module for reference, storage case
Dimensions of the storage case	275 x 230 x 83 mm



Accessories for RFID LifeCheck SPD Test Devices

RFID LifeCheck Sensor for DRC BXT

Snap-on RFID LifeCheck sensor and test module for use as a spare part / extension for portable RFID LifeCheck test devices.

Type	LCS DRC BXT
Part No.	910 652
For testing	BLITZDUCTOR XT ML





SPD Test Device

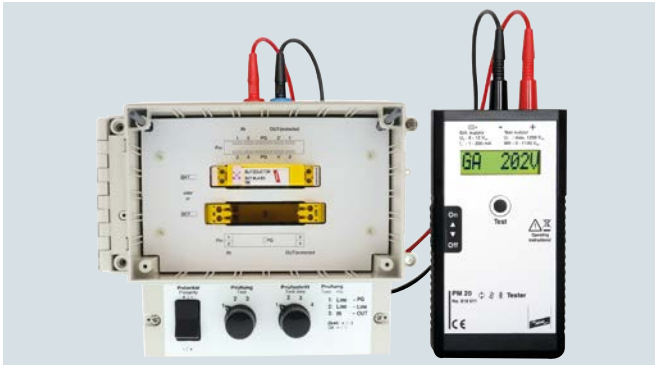

- For routine tests of surge protective devices
- Compact dimensions
- Suitable for mains and battery operation
- Low battery indicator
- Test leads included in delivery
- Touch-protected test adapter for modular arresters of the XT/XTU/SP series available as an accessory

For testing the sparkover voltage of surge arresters. The specimen is connected via the supplied test leads or special test adapters.

The PM 20 SPD test device with integrated sparkover detection is used to test Yellow/Line and Red/Line surge arresters with integrated varistor, Zener diode or gas discharge tube. Both the sparkover performance between the connections of the arresters as well as the continuity can be

tested. The results can be compared to the limit values specified in the instructions for use. In case of deviations, the arrester or protection module must be replaced. A test adapter with a corresponding support makes it easier to test arresters of the BLITZDUCTOR XT/XTU/SP product family.



Indication of the measured spark-over voltage.



The sparkover performance of gas discharge tubes, varistors and Zener diodes can be tested.



Insulated test leads are included in delivery.



Test adapter for modular arresters.

PM 20

Combined device for testing the sparkover voltage of surge arresters (with gas discharge tubes /varistors/Zener diodes). Storage bag and measuring accessories included.



Type	PM 20
Part No.	910 511
Nominal voltage (d.c.) (U _N)	8-12 V d.c.
Test parameter: Test voltage	max. 1250 V d.c.
Measured value indication	alphanumeric, eight-digit LCD
Accessories included in delivery	2 test leads (each 1 m long), 2 safety tapping test clips, 1 plug-in power supply unit (230 V a.c.), 1 storage bag
Dimensions of the storage bag	300 x 110 x 110 mm

Accessories for SPD Test Device



PA BXT Test Adapter

To be connected to PM 10 / PM 20. For inserting and testing protection modules.

Type	PA BXT
Part No.	910 508
For protection modules	BLITZDUCTOR XT / SP / CT

Outdated Part No.	Type	Current Product Part No.	Type
Pluggable SPDs – DIN Rail Mounted			
920 383	BXT M2 BD S EX 24	927 284	BCO ML2 BD EX 24
926 220	BSP M2 BE 5	927 222	BCO ML2 BE 12
926 222	BSP M2 BE 12	927 222	BCO ML2 BE 12
926 224	BSP M2 BE 24	927 224	BCO ML2 BE 24
926 225	BSP M2 BE 48	927 225	BCO ML2 BE 48
926 226	BSP M2 BE 60	920 326	BXT ML4 BE 60
926 227	BSP M2 BE 180	927 327	BXT ML4 BE 180
926 240	BSP M2 BD 5	927 242	BCO ML2 BD 12
926 242	BSP M2 BD 12	927 242	BCO ML2 BD 12
926 244	BSP M2 BD 24	927 244	BCO ML2 BD 24
926 245	BSP M2 BD 48	927 245	BCO ML2 BD 48
926 246	BSP M2 BD 60	920 346	BXT ML4 BD 60
926 247	BSP M2 BD 180	920 347	BXT ML4 BD 180
926 270	BSP M2 BE HF 5	927 270	BCO ML2 BE HF 5
926 271	BSP M2 BD HF 5	927 271	BCO ML2 BD HF 5
926 320	BSP M4 BE 5	927 222 (2x)	BCO ML2 BE 12
926 322	BSP M4 BE 12	927 222 (2x)	BCO ML2 BE 12
926 324	BSP M4 BE 24	927 224 (2x)	BCO ML2 BE 24
926 325	BSP M4 BE 48	927 225 (2x)	BCO ML2 BE 48
926 326	BSP M4 BE 60	920 326 (2x)	BXT ML4 BE 60
926 327	BSP M4 BE 180	920 327 (2x)	BXT ML4 BE 180
926 340	BSP M4 BD 5	927 242 (2x)	BCO ML2 BD 12
926 342	BSP M4 BD 12	927 242 (2x)	BCO ML2 BD 12
926 344	BSP M4 BD 24	927 244 (2x)	BCO ML2 BD 24
926 345	BSP M4 BD 48	927 245 (2x)	BCO ML2 BD 48
926 346	BSP M4 BD 60	920 346 (2x)	BXT ML4 BD 60
926 347	BSP M4 BD 180	920 347 (2x)	BXT ML4 BD 180
926 370	BSP M4 BE HF 5	927 270 (2x)	BCO ML2 BE HF 5
926 371	BSP M4 BD HF 5	927 271 (2x)	BCO ML2 BE HF 5

Accessories for SPDs – DIN Rail Mounted

917 976	LS 1 50 V DCO	—	
917 977	LS 1 50 H DCO	—	
920 394	ML BXT M4 T	—	

Compact SPDs – DIN Rail Mounted

917 900	DCO SD2	—	
917 920	DCO SD2 ME 12	927 922	BCO CL2 BE12
917 921	DCO SD2 ME 24	927 924	BCO CL2 BE 24
917 922	DCO SD2 ME 48	927 925	BCO CL2 BE 48
917 940	DCO SD2 MD 12	927 942	BCO CL2 BD 12
917 941	DCO SD2 MD 24	927 944	BCO CL2 BD 24
917 942	DCO SD2 MD 48	927 945	BCO CL2 BD 48
917 960	DCO SD2 MD EX 24	927 984	BCO CL2 BD EX 24
917 970	DCO SD2 MD HF 5	927 971	BCO CL2 BD HF 5
918 400	BVT TTY 24	—	
918 407	BVT MTTY 25	—	
918 410	BVT ISDN	—	

Outdated Part No.	Type	Current Product Part No.	Type
SPDs for LSA Technology			
907 420	DRL RE 5	907 421	DRL RE 12
907 440	DRL RD 5	907 441	DRL RD 12
907 465	DRL HD 5	907 470	DRL HD 24

SPDs for Telecommunication and Data Networks

929 024	DLI ISDN I	—	
929 028	DLI TC 2 I	—	
929 035	NET PRO 4TP	929 121 (8x)	DPA M CLE RJ45B 48
929 036	NET PRO LSA 4TP	—	
929 037	NET Pro 4TP 30	929 121 (8x)	DPA M CLE RJ45B 48
929 071	NET PRO TC 2	—	
929 072	NET PRO TC 2 LSA	—	
929 075	NET PRO E1 LSA G703	—	
929 110	DPA M CAT6 RJ45H 48	929 100	DPA M CAT6 RJ45S 48
929 230	NET PRO 10X TC1 RST	—	

Accessories for SPDs for Telecommunication and Data Networks

929 034	EG NET PRO 19"	—	
929 234	EG NET PRO 10X 19"	—	
929 235	EG NET PRO 10X 3HE	—	

SPDs for Building Systems

909 320	DPRO 230 ISDN	—	
922 200	DBX U2 KT BD S 0-180	922 210	DBX TC 180
922 210	DBX TC 180	922 220	DBX TC B 180
929 024	DLI ISDN I	—	
929 028	DLI TC 2 I	—	
929 081	DLI ECO RJ12	—	

SPDs for Coaxial Connection

929 040	DGA F 1.6 5.6	—	
929 046	DGA LG 7 16	929 146	DGA LG 7 16 MFA
929 048	DGA L4 7 16 B	929 148	DGA L4 7 16 MFA
929 057	DGA AG U	—	
929 059	DGA L4 N EB	—	
929 446	DGA LG 7 16 X	929 146	DGA LG 7 16 MFA

SPDs for SUB-D Connection

924 019	FS 9E HS 12	—	
924 046	USD 25V24 HS S B	—	
924 051	USD 15 V11 S B	—	

Shield Connection Systems and Enclosures

906 059	MS ALGA 5 X	—	
919 013	SH2 18X3 ST	919 012	SH1 18X3 ST

Accessories for Measuring and Test Devices

910 507	PA DRL	—	
---------	--------	---	--



DEHN protects.

LIGHTNING EQUIPOTENTIAL BONDING

Isolating Spark Gaps and Components





For lightning equipotential bonding according to IEC 62305 as well as for use in IT installations according to IEC 60364-5-54.

- For indirect connection / earthing of functionally isolated parts of installations under lightning conditions
- For lightning equipotential bonding according to IEC 62305
- With corrosion-resistant stainless steel connections
- For installation in buildings, outdoor locations and damp rooms as well as for underground installation
- Extremely heavy-duty devices

TFS: High-capacity isolating spark gap

KFSU: Isolating spark gap

TFS / KFSU

Isolating spark gaps with plastic sheath and two stainless steel connections (Rd 10 mm).



Type	TFS	KFSU
Part No.	923 023	923 021
Isolating spark gap according to EN 62561-3 / IEC 62561-3	yes	yes
Lightning impulse current (10/350 μ s) (I_{imp})	100 kA	—
Class (lightning current carrying capability)	H	—
Rated impulse sparkover voltage ($U_{r imp}$)	≤ 4 kV	≤ 4 kV
Degree of protection protection	IP 65	IP 65



EXFS L / EXFS KU

- For indirect connection / earthing of functionally isolated parts of installations under lightning conditions
- For lightning equipotential bonding according to IEC 62305 in hazardous areas (zone 2)
- Corrosion-resistant zinc die-cast enclosure with plastic cover and flexible cable connection
- For bridging insulating joints, insulating flanges, etc. in cathodically protected pipe sections
- Extremely heavy-duty device
- Approval according to ATEX directive 94/9/EC and IECEx



ATEX and IECEx-certified isolating spark gap for lightning equipotential bonding according to IEC 62305 with flexible cable connection.

EXFS L ...: Isolating spark gap for use in hazardous areas with flexible connecting cable

EXFS KU: Isolating spark gap for use in hazardous areas with two 1.5 m long connecting cables for underground installation

Ex isolating spark gaps of the EXFS L / EXFS KU product line are used when electrically conductive parts of installations cannot be directly interconnected in hazardous areas, for example, in case of cathodically protected pipeline sections.

ATEX and IECEx-certified EXFS L and EXFS KU spark gaps provide approved safety in accordance with harmonised European standards.

The arc-resistant tungsten / copper electrodes ensure a long service life of the Ex spark gaps.

The approved EXFS L Type with flexible cable connection quickly adapts to any application environment. The prewired spark gaps feature connecting cables of different lengths with cable lug, screw and M10 nut. The flat or angled connection brackets (IF), which are available as accessories, enable simple connection of the spark gap to pipeline flanges.

The EXFS KU Type is enclosed by a water-proof PVC sheath and is thus ideally suited for underground installation on insulating couplings.

EXFS L

Ex isolating spark gap for aboveground installation.

Type EXFS ...	L100	L200	L300
Part No.	923 060	923 061	923 062
Isolating spark gap according to EN 62561-3 / IEC 62561-3	yes	yes	yes
Lightning impulse current (10/350 µs) (I_{imp})	50 kA	50 kA	50 kA
Class (lightning current carrying capability)	N	N	N
Rated impulse sparkover voltage ($U_{r imp}$)	≤ 2.5 kV	≤ 2.5 kV	≤ 2.5 kV
Degree of protection	IP 54	IP 54	IP 54
ATEX approvals	DEKRA 11ATEX0146 X	DEKRA 11ATEX0146 X	DEKRA 11ATEX0146 X
Ex marking according to EN 60079-0 and EN 60079-15: gas	II 3 G Ex nC IIC T4 Gc	II 3 G Ex nC IIC T4 Gc	II 3 G Ex nC IIC T4 Gc
IECEx approvals	IECEx DEK 11.0063X	IECEx DEK 11.0063X	IECEx DEK 11.0063X
Ex marking according to EN 60079-0	Ex nC IIC T4 Gc	Ex nC IIC T4 Gc	Ex nC IIC T4 Gc
Cable length	100 mm	200 mm	300 mm



EXFS KU

Ex isolating spark gap with connecting cables for aboveground and underground installation; with water-proof sheath; can be shortened to keep cables as short as possible.

Type EXFS ...	KU
Part No.	923 019
Isolating spark gap according to EN 62561-3 / IEC 62561-3	yes
Lightning impulse current (10/350 µs) (I_{imp})	50 kA
Class (lightning current carrying capability)	N
Rated impulse sparkover voltage ($U_{r imp}$)	≤ 2.5 kV
Degree of protection	IP 67
ATEX approvals	DEKRA 11ATEX0146 X
Ex marking according to EN 60079-0 and EN 60079-15: gas	II 3 G Ex nC IIC T4 Gc
IECEx approvals	IECEx DEK 11.0063X
Ex marking according to EN 60079-0	Ex nC IIC T4 Gc
Cable length	2x approx. 1500 mm





EXFS 100 / EXFS 100 KU



ATEX and IECEx-certified isolating spark gap with a low sparkover voltage for lightning equipotential bonding according to IEC 62305.

- For indirect connection / earthing of functionally isolated parts of installations under lightning conditions
- Device for lightning equipotential bonding according to IEC 62305 in hazardous areas
- For bridging insulating joints, insulating flanges, etc. in cathodically protected pipe sections
- For safe installation in Ex zone 1 (gas) or 21 (dust)
- Extremely low sparkover voltage
- Extremely high alternating current withstand capability
- Approval according to ATEX directive 94/9/EC, IECEx, UL and Inmetro

EXFS 100: Isolating spark gap for use in hazardous areas with plastic sheath and M10 threaded bushings

EXFS 100 KU: Isolating spark gap for use in hazardous areas with two 2 m long connecting cables for underground installation

The Ex isolating spark gaps of the EXFS 100 / EXFS 100 KU product family are used when conductive installation parts situated in hazardous areas cannot be directly interconnected.

The spark gaps with low sparkover voltage are especially efficient for isolated parts of installations with low insulation strength.

No special requirements have to be observed for safe installation in zone 1 (gases) or zone 21 (dusts).

With a maximum lightning impulse current of 100 kA (10/350 μ s), EXFS 100 and EXFS 100 KU meet class H requirements (highest lightning current carrying capability class).

The ATEX and IECEx-certified EXFS 100 and EXFS 100 KU spark gaps provide approved safety according to harmonised European standards.

Prewired connection cables in different lengths are available as accessories for connecting EXFS 100 spark gaps. Flat and angled connection brackets (IF) enable simple connection of the spark gaps to pipeline flanges.

EXFS 100 KU Types are enclosed by a water-proof plastic sheath and are therefore ideally suited for underground installation on insulating couplings.

EXFS 100

Isolating spark gap for use in hazardous areas with plastic sheath and M10 threaded screws.



Type EXFS ...	100
Part No.	923 100
Isolating spark gap according to EN 62561-3 / IEC 62561-3	yes
Lightning impulse current (10/350 μ s) (I_{imp})	100 kA
Class (lightning current carrying capability)	H
Rated impulse sparkover voltage ($U_{r,imp}$)	≤ 1.25 kV
Degree of protection	IP 67
Approvals	UL, Inmetro
ATEX approvals	DEKRA 11ATEX0178 X
Ex marking according to EN 60079-0 and EN 60079-1: gas	II 2 G Ex db IIC T6 Gb
Ex marking according to EN 60079-0 and EN 60079-31: dust	II 2 D Ex tb IIIC T80 °C Db IP 66/67
IECEx approvals	IECEx KEM 09.0051X
Ex marking according to EN 60079-0 and EN 60079-1: gas	Ex db IIC T6 Gb
Ex marking according to EN 60079-0 and EN 60079-31: dust	Ex tb IIIC T80 °C Db IP 66/67
Inmetro approvals	TÜV 17.0698 X
Ex marking according to EN 60079-0 and EN 60079-1: gas	Ex db IIC T6 Gb
Ex marking according to EN 60079-0 and EN 60079-31: dust	Ex tb IIIC T80 °C Db IP 66/67

Isolating Spark Gaps

EXFS 100 KU

Ex isolating spark gap with connecting cable for aboveground and underground installation; with water-proof sheath; can be shortened to keep cables as short as possible.

Type EXFS ...	100 KU
Part No.	923 101
Isolating spark gap according to EN 62561-3 / IEC 62561-3	yes
Lightning impulse current (10/350 μ s) (I_{imp})	100 kA
Class (lightning current carrying capability)	H
Rated impulse sparkover voltage ($U_{r imp}$)	≤ 1.25 kV
Degree of protection	IP 67
Approvals	UL, Inmetro
ATEX approvals	DEKRA 11ATEX0178 X
Ex marking according to EN 60079-0 and EN 60079-1: gas	II 2 G Ex d IIC T6 Gb
Ex marking according to EN 60079-0 and EN 60079-31: dust	II 2 D Ex tb IIIC T80 °C Db IP 66/67
IECEX approvals	IECEX KEM 09.0051X
Ex marking according to EN 60079-0 and EN 60079-1: gas	Ex d IIC T6 Gb
Ex marking according to EN 60079-0 and EN 60079-31: dust	Ex tb IIIC T80 °C Db IP 66/67
Inmetro approvals	TÜV 17.0698 X
Ex marking according to EN 60079-0 and EN 60079-1: gas	Ex db IIC T6 Gb
Ex marking according to EN 60079-0 and EN 60079-31: dust	Ex tb IIIC T80 °C Db IP 66/67
Cable length	2x approx. 2000 mm



Accessories for EXFS 100 / EXFS 100 KU

Angled connection brackets – IF 1 –

Angled connection bracket for EXFS ...; diameter corresponds to the bolt diameter of the flange joint; material: St/tZn.

Type	AB EXFS IF1 W 11	AB EXFS IF1 W 14	AB EXFS IF1 W 18	AB EXFS IF1 W 22
Part No.	923 311	923 314	923 318	923 322
Borehole diameter d1	11 mm	14 mm	18 mm	22 mm

Type	AB EXFS IF1 W 26	AB EXFS IF1 W 30	AB EXFS IF1 W 33
Part No.	923 326	923 330	923 333
Borehole diameter d1	26 mm	30 mm	33 mm

Type	AB EXFS IF1 W 36	AB EXFS IF1 W 39	AB EXFS IF1 W 42
Part No.	923 336	923 339	923 342
Borehole diameter d1	36 mm	39 mm	42 mm

Type	AB EXFS IF1 W 48	AB EXFS IF1 W 56	AB EXFS IF1 W 62
Part No.	923 348	923 356	923 362
Borehole diameter d1	48 mm	56 mm	62 mm



Flat connection brackets – IF 3 –

Flat connection bracket for EXFS ...; diameter corresponds to the bolt diameter of the flange joint; material: St/tZn.

Type	AB EXFS IF3 G 11	AB EXFS IF3 G 14	AB EXFS IF3 G 18	AB EXFS IF3 G 22
Part No.	923 211	923 214	923 218	923 222
Borehole diameter d1	11 mm	14 mm	18 mm	22 mm

Type	AB EXFS IF3 G 26	AB EXFS IF3 G 30	AB EXFS IF3 G 33
Part No.	923 226	923 230	923 233
Borehole diameter d1	26 mm	30 mm	33 mm

Type	AB EXFS IF3 G 36	AB EXFS IF3 G 39	AB EXFS IF3 G 42
Part No.	923 236	923 239	923 242
Borehole diameter d1	36 mm	39 mm	42 mm



EXFS 100: Connecting Cable, Cu, 25 mm²

Connecting cable for EXFS 100; two cable lugs (Ø10.5 mm) made of Cu/gal Sn, screw, nut and spring washer.

Type	AL EXFS L100 KS	AL EXFS L200 KS	AL EXFS L300 KS	!
Part No.	923 025	923 035	923 045	
Cable length	100 mm	200 mm	300 mm	





EXFS Coaxial Connection Box



Coaxial connection of the Ex isolating spark gap for protecting buried insulating joints

- For bridging buried insulating joints in cathodically protected pipe sections of pipelines
- For protecting insulating joints in potentially explosive atmospheres
- Voltage drop across the coaxial cable is up to three times lower than across a conventional connection cable. Depending on the insulation strength of the insulating joint, the length of the connection cable can be up to 5 m
- The integrated EXFS 100 spark gap is thus inspected and replaced outside the Ex area / above ground (no excavation work needed)
- Version for lightning equipotential bonding according to IEC 62305 in hazardous areas
- Spark gap is easily accessible since cables do not have to be disconnected and insulations do not have to be removed during inspection
- Delivery does not include fixing accessory

NAK SN4631: Coaxial connection box with integrated Ex isolating spark gap EXFS 100

The coaxial connection box with integrated Ex isolating spark gap EXFS 100 protects buried insulating joints and flanges, e.g. when bridging insulating joints in cathodically protected pipe sections.

The insulating joint or flange is connected to the coaxial connection box via a coaxial connecting cable, thus achieving an up to three times better protective effect than in case of a conventional connecting cable of comparable length. Consequently, the coaxial connection box has the advantage that the insulation strength of the insulating joint is not exceeded even in case of long connecting cables. Moreover, this solution allows simple inspection of the Ex isolating spark gap EXFS 100, even if it is installed underground.

The coaxial connection box is supplied with all necessary fixing and assembly accessories, thus ensuring easy installation.

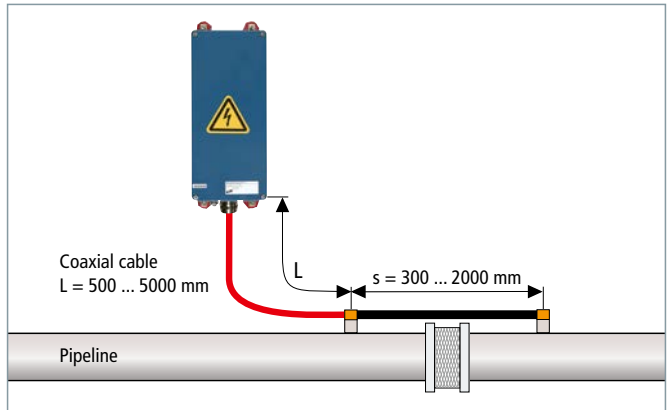

Application example NAK SN4631

Coaxial Connection Box with EXFS 100

Coaxial connection of isolating spark gaps with a low sparkover voltage for lightning equipotential bonding according to IEC 62305.



Type	NAK SN4631
Part No.	999 990
Isolating spark gap acc. to EN 62561-3 / IEC 62561-3	yes
Lightning impulse current (10/350 μs) (I _{imp})	100 kA
Nominal discharge current (8/20 μs) (I _n)	100 kA
Rated impulse sparkover voltage (U _{r,imp})	≤ 1.25 kV
Degree of protection protection	IP 67 (UV-resistant)



Voltage Controlled Smart Decoupling Device VCSD

- **VCSD: Voltage Controlled Smart Decoupling Device**
- Protection in case of transient, temporary and long-duration overvoltages
- Does not negatively affect cathodic protection equipment
- Adjustable response threshold for flexible use in a wide range of applications and operating states



VCSD 40 IP65: Voltage-controlled smart decoupling device with adjustable response threshold

The smart decoupling device VCSD 40 IP65 is a short-circuiting switch which is controlled by overvoltage and limits long-duration, temporary and transient overvoltages. With the exception of direct currents, the VCSD is capable of discharging all interference voltages and limiting them to a preset value without negatively affecting the d.c. potential (cathodic protection potential). It limits the effects of dangerous high overvoltages in its immediate vicinity to a safe level.

Limiting behaviour of VCSD 40 IP65 in the time range

Transient overvoltages are limited to values < 1.25 kV (time range: up to 1 ms).

Temporary overvoltages are limited to values < 940 V depending on the duration (time range: 1 ms to 200 ms).

Long-duration overvoltages are limited to values between 3 and 50 V a.c. (adjustable) (time range: > 200 ms).

Functional description

Thanks to the coordinated and tested interaction of the functional units within the VCSD, the following overvoltage-related effects can be prevented:

Undefined, lightning-related puncture and flashover at insulating clearances

Lightning-related overvoltage is limited and the associated lightning currents are discharged to local earth.

Dangerous touch voltages at accessible places

Dangerous touch voltages are limited to below the maximum permissible touch voltage for the duration of their occurrence.

Reduction of a.c. corrosion caused by a.c. interference

Technical alternating currents between 16.7 Hz and 60 Hz can be permanently discharged to low-impedance earth electrodes without negatively affecting the cathodic protection potential on long-distance pipelines.

Monitoring / controlling

Due to the digital and analogue interfaces, the VCSD 40 IP65 can be externally controlled, device faults can be displayed and discharge currents can be signalled in the form of a 4 – 20 mA signal (scaled to 0 – 40 A).

Fields of application

The VCSD 40 IP65 is ideally suited for pipelines which are influenced by lightning strikes, electric railways or high-voltage lines. Typical fields of application are remote insulated pipeline sections, cathodically protected containers / storage tanks, open earthing of cable shields at accessible places or the corrosion-free interconnection of isolated earth-termination systems such as the foundation earth electrodes of a building and an isolated signal ground or railway earth electrode.

Advantages of the VCSD 40 IP65 are the flexible and controllable use in different fields of application, the high discharge capacity as well as a tested, comprehensive, coordinated protection solution from the surge protection specialist DEHN.

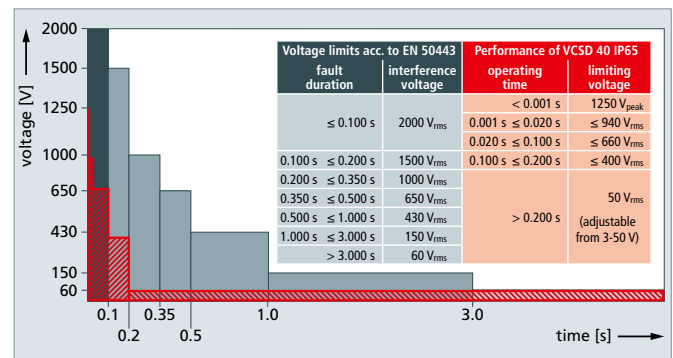

Limiting behaviour of the VCSD

VCSD 40 IP65

Voltage-controlled smart decoupling device with adjustable response threshold for flexible use in a wide range of systems.



Type	VCSD 40 IP65
Part No.	923 401
Transient discharge current (10/350 μ s)	100 kA
Transient discharge current (8/20 μ s)	100 kA
Temporary discharge current (16.7 Hz, 50 Hz, 60 Hz)	1.1 kA _{rms} (up to 200 ms) * ¹⁾
Temporary discharge current (16.7 Hz, 50 Hz, 60 Hz)	500 A _{rms} (up to 1 s)
Long-duration discharge current (16.7 Hz, 50 Hz, 60 Hz)	45 A _{rms} (permanently) * ²⁾
Long-duration limiting voltage (a.c. _{rms}) (> 200 ms)	max. 50 V (adjustable from 3 to 50 V)
Degree of protection	IP 65
Dimensions	400 x 300 x 150 mm

*¹⁾ Derating depends on the "biasing current" (long-duration discharge current) and on the ambient temperature

*²⁾ Derating depends on the ambient temperature
See instructions for use and installation instructions

Accessories for Voltage-controlled smart decoupling device VCSD

DGP M – 100 kA N-PE Spark-Gap-Based Protection Module

N-PE spark-gap-based protection module for all devices of the modular DEHNgap M family.



Type	DGP M MOD 255
Part No.	961 010
Max. continuous operating voltage (a.c.) (U _c)	255 V



Pipe Clamps for Ex Zones 1/21, 2/22

- For use in Ex zones 1 and 2 (gases, vapours, mists) as well as Ex zones 21 and 22 (dusts)
- Tested according to explosion group IIB
- Time-saving installation – no need to deactivate systems / areas for welding or drilling work

- EX BRS 27: Clamping range from Ø6-27 mm (3/4")
- EX BRS 90: Clamping range from Ø27 (3/4") to 89 mm (3")
- EX BRS 300: Clamping range from Ø89 (3") to 300 mm
- EX BRS 500: Clamping range from Ø300 to 500 mm
- Separate clamping body: Clamping range from Ø27 (3/4") to 500 mm



Pipe clamp for electrical contacting pipes in hazardous areas for implementing lightning equipotential bonding according to IEC / EN 62305-3

In the past, connections for equipotential bonding and lightning equipotential bonding in Ex zones were often welded or threaded bushing connections. Clamps may only be used if absence of ignition sparks in case of lightning currents is proven. DEHN has provided evidence of absence of ignition sparks under lightning current load for the pipe clamps. The clamp has been tested according to EN 50164-1 title English: Lightning Protection Components (LPC) - Part 1: Requirements for connection components in a potentially explosive atmosphere (clamps and connectors) and the absence of ignition sparks under lightning current load of up to 50 kA (10/350 µs) has been proven. This novel, patented pipe clamp for hazardous areas not only ensures safe electrical contact by means of two contact clips, but also adequate mechanical fixing by an electrically insulated clamping body.

- The Ex pipe clamp provides the following connection possibilities:
- Round conductors made of Cu, St/tZn, Al, StSt with Ø8/10 mm or flexible / stranded copper conductors, cross section 16-35 mm², with E-Cu crimping cable lug (DIN 46235)
 - Flat copper conductors, min. 20 x 2.5 mm, with bore Ø10.5 mm

With regard to corrosion resistance, it must be checked whether the materials used for the Ex pipe clamps Ex BRS ... (e.g. Cu/galSn, brass/galSn, StSt, polyamide) can be used in the existing ambient conditions.



Installed at a StSt pipe.



DEHN + SÖHNE

DECLARATION OF MANUFACTURER

Product: Pipe clamp for explosive zones

Product description: Part No. 540 821
Part No. 540 801
Part No. 540 803
Part No. 540 805
Part No. 540 810

Manufacturer: DEHN + SÖHNE GmbH + Co.KG.
Hans-Dehn-Str. 1
92318 Neumarkt i.d.OPf., Germany

Application:

The pipe clamp for explosive zones is used for connecting pipes of different materials and diameters to the lightning equipotential bonding structure in explosive atmospheres.

Lightning currents are discharged without formation of sparks as specified in the technical data sheet.

We herewith confirm that the pipe clamp for explosive zones is suitable for the use in explosive zones 1 and 2 (gas, vapour, mist) and explosive zones 21 and 22 (combustible dust) in connection with the installation instructions, Publication No. 1599, "Pipe Clamp for explosive zones" and is tested according to explosion group IIB.

Pipe clamps for explosive zones have no own potential source of ignition (mechanical device) and are thus not subject to the European directive 94/9/EG.

Therefore certification according to the European directive 94/9/EG is **not legally admissible** and **not necessary** with respect to explosion protection.

Neumarkt i.d.OPf., 12 Okt. 2009

Dr.-Ing. Ralph Brocke
Director R&D

cidbaume - Fotostabale - Fremdpublizierenherstellerklärung bandrohrschelle im bereich 1 und die ausführung klein und groß eng. doc
Page 11

Type EX BRS 27

Clamping range of Ø6-27 mm (3/4")



Type	EX BRS 27
Part No.	540 821
Lightning impulse current (10/350 µs) Cu Ø6-12 mm (I _{imp})	10 kA
Lightning impulse current (10/350 µs) Cu Ø12-27 mm (3/4") (I _{imp})	20 kA
Lightning impulse current (10/350 µs) Cu Ø27 mm (3/4") (I _{imp})	25 kA
Lightning impulse current (10/350 µs) St/tZn Ø17-27 mm (3/4") (I _{imp})	25 kA
Lightning impulse current (10/350 µs) StSt Ø6-12 mm (I _{imp})	10 kA
Lightning impulse current (10/350 µs) StSt Ø12-27 mm (3/4") (I _{imp})	12 kA
Lightning impulse current (10/350 µs) StSt Ø27 mm (3/4") (I _{imp})	25 kA
Connection	M8
Clamping range pipe Ø	6-27 mm (3/4")
Material of clamping body	polyamide
Material of grip head / tensioning strap	StSt
Material of contact piece	brass/gal Sn
Standard	based on EN 62561-1

Type EX BRS 90 / 300 / 500

Type EX BRS 90 (Part No. 540 801) clamping range Ø27 (3/4") to 89 mm (3").

Type EX BRS 300 (Part No. 540 803) clamping range Ø89 (3") to 300 mm.

Type EX BRS 500 (Part No. 540 805) clamping range Ø300 to 500 mm.



Type	EX BRS 90	EX BRS 300	EX BRS 500
Part No.	540 801	540 803	540 805
Lightning impulse current (10/350 µs) Cu (I _{imp})	50 kA	50 kA	—
Lightning impulse current (10/350 µs) St/tZn (I _{imp})	50 kA	50 kA	—
Lightning impulse current (10/350 µs) St/bare (I _{imp})	—	—	50 kA
Lightning impulse current (10/350 µs) StSt (I _{imp})	25 kA	50 kA	50 kA
Connection	M10	M10	M10
Clamping range pipe Ø	27-89 mm (3/4"-3")	89 (3")-300 mm	300-500 mm
Material of clamping body	polyamide	polyamide	polyamide
Material of grip head / tensioning strap	StSt	StSt	StSt
Material of contact piece	Cu/gal Sn	Cu/gal Sn	Cu/gal Sn
Standard	EN 62561-1	EN 62561-1	EN 62561-1

Separate clamping body

For use with endless tensioning strap (Part No. 540 901), clamping ranges Ø27 (3/4") to 500 mm.



Type	SCK EX BRS ASSM10 V2A
Part No.	540 810
Lightning impulse current (10/350 µs) Cu (I _{imp})	50 kA
Lightning impulse current (10/350 µs) St/tZn (I _{imp})	50 kA
Lightning impulse current (10/350 µs) StSt (I _{imp})	25 kA
Connection	M10
Clamping range pipe Ø	27 (3/4")-500 mm
Material of clamping body	polyamide
Material of grip head / tensioning strap	StSt
Material of contact piece	Cu/gal Sn
Standard	EN 62561-1

Accessories for Pipe Clamps for Ex Zones 1/21, 2/22

Tensioning strap



Type	SPB 25X0.3 L100M V2A
Part No.	540 901
Material	StSt
Strap dimensions (w x d)	25 x 0.3 mm
Length	100 m

Voltage Limiting Devices

- Electrical isolation of insulated track sections and earthed parts of installations
- Safe equipotential bonding in case of a short-circuit or earth fault at the overhead contact line due to high-current-resistant welding of the electrodes
- Discharge of lightning overvoltages without short-circuit formation due to lightning-resistant SDS ... voltage limiting device
- Short-circuit withstand capability
up to 25 kA_{rms} / 100 ms; 36 kA_{rms} / 75 ms



EN 50122-1 describes the use of voltage limiting devices for d.c. and a.c. traction systems for so-called "open traction system earthing" of conductive components of the overhead contact line and pantograph zone. Voltage limiting devices (SDS ...) are used to prevent the occurrence of hazardous surges between the insulated tracks or track sections of electric railways and earthed parts of the installation.

The SDS voltage limiting device consists of a spark gap unit and the respective connecting kit and can be directly connected to the rail or overhead contact line tower.

Their function is to permanently connect parts of the installation in the overhead contact line and pantograph zone to the return circuit as soon as the threshold voltage is exceeded.

The spark gap unit of type SDS 1 (Part No. 923 110) developed by DEHN has also been approved by the German Federal Railway Authority (EBA).

In case of atmospheric overvoltages, the lightning-resistant SDS ... voltage limiting device is capable of returning to its initial state after discharging the impulse current. Only when the specified lightning current load is exceeded, does a permanent short circuit occur due to high-current-resistant welding of the electrodes, making it necessary to replace the fuse link.



SDS 1 Voltage limiting device for a power-frequency sparkover voltage ≤ 940 V.

Type SDS ...	1
Part No.	923 110
VLD type (EN 50122-1)	VLD-F
Power frequency sparkover voltage (U _{av})	≤ 940 V
d.c. sparkover voltage (U _{ag})	600 V +/- 20 %
Impulse sparkover voltage	≤ 1400 V (1kV/μs)
Self-extinguishing capability	300 A / 65 V
Lightning current discharge capacity (10/350 μs) 0.1x / 0.5x / 1x	5 kA
Lightning current withstand capability (10/350 μs)	25 kA
Safe short-circuit due to welding of the electrodes in case of alternating currents	≥ 2.5 kA / 1000 V / 30 ms, ≥ 1.5 kA / 1000 V / 100 ms
Safe short-circuit due to welding of the electrodes in case of direct currents	≥ 750 A / 250 ms
Short-circuit withstand capability	25 kA _{rms} / 100 ms; 36 kA _{rms} / 75 ms
Long-term current	1 kA _{rms} for t ≤ 120 s
Leakage current (I _{lc})	< 1 μA for 100 V d.c.
Operating temperature range (T _U)	-40 °C ... +80 °C
To be mounted with	mast adapter MA SDS M12 or SIEMENS No. 8WVL6503-xx
Approvals	EBA
DB drawing No.	4 Ebs 15.13.20 Sheet 2



SDS 2 Voltage limiting device for a d.c. sparkover voltage of 350 V.

Type SDS ...	2
Part No.	923 117
VLD type (EN 50122-1)	VLD-F
d.c. sparkover voltage (U _{ag})	350 V +/- 20 %
Impulse sparkover voltage	≤ 900 V (1 kV/μs)
Lightning current discharge capacity (10/350 μs) 0.1x / 0.5x / 1x	2 kA
Lightning current withstand capability (10/350 μs)	25 kA
Safe short-circuit due to welding of the electrodes in case of direct currents	≥ 600 A / 250 ms
Short-circuit withstand capability	25 kA _{rms} / 100 ms; 36 kA _{rms} / 75 ms
Long-term current	1 kA _{rms} for t ≤ 120 s
Leakage current (I _{lc})	< 1 μA for 100 V d.c.
Operating temperature range (T _U)	-40 °C ... +80 °C
To be mounted with	mast adapter MA SDS M12 or SIEMENS No. 8WVL6503-xx



SDS 3

Voltage limiting device for a d.c. sparkover voltage of 550 V.



Type SDS ...	3
Part No.	923 116
VLD type (EN 50122-1)	VLD-F
d.c. sparkover voltage (U_{ag})	550 V +/- 20 %
Impulse sparkover voltage	≤ 1000 V (1 kV/ μ s)
Lightning current discharge capacity (10/350 μ s) 0.1x / 0.5x / 1x	2.5 kA
Lightning current withstand capability (10/350 μ s)	25 kA
Short-circuit withstand capability	25 kA _{rms} / 100 ms
Operating temperature range (T_U)	-40 °C ... +80 °C
To be mounted with	mast adapter MA SDS M12 or SIEMENS Nr. 8WL6503-xx

SDS 4

Voltage limiting device for a d.c. sparkover voltage of 230 V.



Type SDS ...	4
Part No.	923 118
VLD type (EN 50122-1)	VLD-F
d.c. sparkover voltage (U_{ag})	230 V +/- 20%
Impulse sparkover voltage	≤ 650 V (1 kV/ μ s)
Lightning current discharge capacity (10/350 μ s) 0.1x / 0.5x / 1x	2.5 kA
Lightning current withstand capability (10/350 μ s)	25 kA
Impulse current discharge capacity (8/20 μ s) 0.1x / 0.5x / 1x	20 kA
Safe short-circuit due to welding of the electrodes in case of direct currents	≥ 600 A / 250 ms
Short-circuit withstand capability	25 kA _{rms} / 100 ms; 36 kA _{rms} / 75 ms
Long-term current	1 kA _{rms} for $t \leq 120$ s
Leakage current (I_{lc})	< 1 μ A for 100 V d.c.
Operating temperature range (T_U)	-40 °C ... +80 °C
To be mounted with	mast adapter MA SDS M12 or SIEMENS No. 8WL6503-xx

SDS 5

Voltage limiting device for a d.c. sparkover voltage of 120 V.



Type SDS ...	5
Part No.	923 119
VLD type (EN 50122-1)	VLD-F
d.c. sparkover voltage (U_{ag})	120 V +/- 20 %
Impulse sparkover voltage	≤ 600 V (1 kV/ μ s)
Lightning current discharge capacity (10/350 μ s) 0.1x / 0.5x / 1x	2 kA
Lightning current withstand capability (10/350 μ s)	25 kA
Impulse current discharge capacity (8/20 μ s) 0.1x / 0.5x / 1x	20 kA
Safe short-circuit due to welding of the electrodes in case of direct currents	≥ 600 A / 250 ms
Short-circuit withstand capability	25 kA _{rms} / 100 ms; 36 kA _{rms} / 75 ms
Long-term current	1 kA _{rms} for $t \leq 120$ s
Leakage current (I_{lc})	< 1 μ A for 100 V d.c.
Operating temperature range (T_U)	-40 °C ... +80 °C
To be mounted with	mast adapter MA SDS M12 or SIEMENS No. 8WL6503-xx

Accessories for Voltage Limiting Devices

Mast adapter for SDS Voltage Limiting Devices

For installation on the mast profile of overhead contact line masts with $\varnothing 8-12$ mm.



Type	MA SDS M12
Part No.	723 199
Lightning current carrying capability (10/350 μ s)	25 kA
Short-circuit withstand capability	21 kA _{rms} / 30 ms
Long-term current	1 kA _{rms} at $t \leq 120$ s
Leakage current (I_{lc})	< 1 μ A at 100 V d.c.
Dimensions of the threaded pin	M12
Material	Brass
Degree of protection of the inner enclosure	IP 67

Equipotential Busbars

Equipotential Busbars K12 with Snap-on Terminals

For protective and functional equipotential bonding according to IEC 60364-4-41/60364-5-54 and lightning equipotential bonding according to IEC 62305-3.

Standard type

Terminals for: 10 conductors 2.5-95 mm² (solid/stranded) or Rd Ø10 mm
1 conductor Fl up to 30 x 4 mm

Part No.	563 200
Contact bar	Cu/gal Sn
Cross-section	30 mm ²
Standard	EN 62561-1



UV stabilised type

Terminals for: 10 conductors 2.5-95 mm² (solid/stranded) or Rd Ø10 mm
1 conductor Fl up to 30 x 4 mm

Part No.	563 201
Contact bar	Cu/gal Sn
Cross-section	30 mm ²
Standard	EN 62561-1



Equipotential Busbar MS

For equipotential bonding.

Terminals for: 7 conductors Rd 2.5-25 mm² (solid/stranded)
1 conductor Rd Ø7-10 mm
1 conductor Fl up to 30 x 3.5 mm or Rd Ø8-10 mm

Part No.	563 050
Contact bar	Brass
Cross-section	35 mm ²



Equipotential Busbar with Terminal Block System Mini

For protective and functional equipotential bonding according to IEC 60364-4-41 / 60364-5-54 in small systems. Without cover.

Terminals for: 6 conductors 2.5-25 mm² (solid/stranded)

Part No.	563 105
Clamping bar	Brass/gal Sn
Cross-section	100 mm ²
Standard	EN 50164-1



Equipotential Busbars R15 with Terminal Block System / Kit

For protective and functional equipotential bonding according to IEC 60364-4-41 / 60364-5-54 and lightning equipotential bonding according to IEC 62305-3.

Type A

Terminals for: 7 conductors 2.5-25 mm² (solid/stranded)
2 conductors 16-95 mm² (solid/stranded) or Rd Ø8-10 mm
1 conductor Fl up to 30 x 4 mm



Part No.	563 010
Clamping bar	Brass/gal Sn
Cross-section	100 mm ²
Standard	EN 62561-1

Type B

Terminals for: 5 conductors 2.5-25 mm² (solid/stranded)
3 conductors 16-95 mm² (solid/stranded) or Rd Ø8-10 mm
1 conductor Fl up to 30 x 4 mm



Part No.	563 020
Clamping bar	Brass/gal Sn
Cross-section	100 mm ²
Standard	EN 62561-1

Type C

Terminals for: 13 conductors 2.5-25 mm² (solid/stranded)
1 conductor 16-95 mm² (solid/stranded) or Rd Ø8-10 mm



Part No.	563 030
Clamping bar	Brass/gal Sn
Cross-section	100 mm ²
Standard	EN 62561-1

Type D

Terminals for: 7 conductors 2.5-25 mm² (solid/stranded)
2 conductors 16-95 mm² (solid/stranded) or Rd Ø8-10 mm
1 conductor Fl up to 40 x 5 mm



Part No.	563 040
Clamping bar	Brass/gal Sn
Cross-section	100 mm ²
Standard	EN 62561-1

Terminal Block

Terminals for: 1 conductor 2.5-25 mm² (solid/stranded)

Part No.	563 011
Material	St/gal Zn
Modules	1



Terminal Block

Terminals for: 1 conductor 16-95 mm² (solid/stranded) or Rd Ø8-10 mm

Part No.	563 013
Material	St/gal Zn
Modules	2



Terminal Block

Terminals for: 1 conductor Fl up to 30 x 4 mm

Part No.	563 012
Material	St/gal Zn
Modules	4



Terminal Block

Terminals for: 1 conductor Fl up to 40 x 5 mm

Part No.	563 019
Material	St/gal Zn
Modules	5



Clamping bar

Part No.	563 016	563 017	563 018
Material	Brass/gal Sn	Brass/gal Sn	Brass/gal Sn
Length	198 mm	398 mm	798 mm
Modules	15	30	60



Bar Frame

Part No.	563 014
Material	Plastic
Fixing bores	[2x] 6 x 12 mm
Modules	2



Cover

Snap-on / labelable cover.

Part No.	563 015
Material	Plastic
Modules	15



Note: You will find our complete earthing / equipotential bonding and lightning protection portfolio in our Lightning Protection Main Catalogue.

Equipotential Busbars Industry Design

For protective and functional equipotential bonding according to IEC 60364-4-41 / 60364-5-54 and lightning equipotential bonding according to IEC 62305-3, also for use in hazardous areas (screws are secured against self-loosening).

6 terminals



Part No.	472 207	472 209
Material	Cu	StSt
Dimensions (l x w x d1)	295 x 40 x 5 mm	295 x 40 x 6 mm
Cross-section	200 mm ²	240 mm ²
Standard	EN 62561-1	EN 62561-1

8 terminals



Part No.	472 227	472 229
Material	Cu	StSt
Dimensions (l x w x d1)	365 x 40 x 5 mm	365 x 40 x 6 mm
Cross-section	200 mm ²	240 mm ²
Standard	EN 62561-1	EN 62561-1

10 terminals



Part No.	472 217	472 219
Material	Cu	StSt
Dimensions (l x w x d1)	435 x 40 x 5 mm	435 x 40 x 6 mm
Cross-section	200 mm ²	240 mm ²
Standard	EN 62561-1	EN 62561-1

12 terminals



Part No.	472 237	472 239
Material	Cu	StSt
Dimensions (l x w x d1)	505 x 40 x 5 mm	505 x 40 x 6 mm
Cross-section	200 mm ²	240 mm ²
Standard	EN 62561-1	EN 62561-1

Accessories for Equipotential Busbars

Covers for EBB Industry Design

With insulators.



Part No.	472 279	472 269	472 289	472 299
Type of EBB	6 terminals	8 terminals	10 terminals	12 terminals
Dimensions (l x w x d1)	301 x 60 x 0.8 mm	371 x 60 x 0.8 mm	441 x 60 x 0.8 mm	551 x 60 x 0.8 mm
Material	StSt	StSt	StSt	StSt

Insulator for EBB Industry Design



Part No.	472 210
Material	UP (thermoset)
Connection thread	M10 (length 12 mm)
Dimensions (d x h)	32 x 40 mm

Fixing Kit for EBB Industry Design



Part No.	472 201	472 202
Material of screw	St/tZn	StSt
Screw	45 mm \times M10 x 20 mm	45 mm \times M10 x 20 mm
Plastic dowel	Ø12 x 60 mm	Ø12 x 60 mm

Note: You will find our complete earthing / equipotential bonding and lightning protection portfolio in our Lightning Protection Main Catalogue.

Earthing Busbars, single-row

For screwing on steel constructions, borehole spacing of 35 mm.

1x 4 terminals

Part No.	472 309
Material	StSt
Cross-section	105 mm ²
Borehole	11 x 11 mm



1x 6 terminals

Part No.	472 319
Material	StSt
Cross-section	105 mm ²
Borehole	11 x 11 mm



1x 8 terminals

Part No.	472 329
Material	StSt
Cross-section	105 mm ²
Borehole	11 x 11 mm



1x 10 terminals

Part No.	472 339
Material	StSt
Cross-section	105 mm ²
Borehole	11 x 11 mm



1x 12 terminals

Part No.	472 349
Material	StSt
Cross-section	105 mm ²
Borehole	11 x 11 mm



Earthing Busbars, two-row

For screwing to steel constructions, borehole spacing of 50 mm.

2x 2 terminals

Part No.	472 023	472 109
Material	St/tZn	StSt
Cross-section	240 mm ²	300 mm ²
Borehole Ø	11 mm	11 mm



2x 3 terminals

Part No.	472 022	472 119
Material	St/tZn	StSt
Cross-section	240 mm ²	300 mm ²
Borehole Ø	11 mm	11 mm



2x 4 terminals

Part No.	472 024	472 129
Material	St/tZn	StSt
Cross-section	240 mm ²	300 mm ²
Borehole Ø	11 mm	11 mm



2x 6 terminals

Part No.	472 021	472 139
Material	St/tZn	StSt
Cross-section	240 mm ²	300 mm ²
Borehole Ø	11 mm	11 mm



Note: You will find our complete earthing / equipotential bonding and lightning protection portfolio in our Lightning Protection Main Catalogue.

Connecting Clamps

Connecting Clamps for Reinforcements

To connect the reinforcing steel mesh or reinforcement to round and flat conductors. Arrangement: (II) = parallel (+) = cross

For T, cross and parallel connections

Part No.	308 025
Material	St/tZn
Clamping range Rd / Rd	(+) 6-10 / 6-10 mm
Clamping range Rd / Fl	(+) 6-10 / 30 mm
Clamping range Fl / Fl	(II) 30 / 30 mm

For T, cross and parallel connections

Part No.	308 026
Material	St/tZn
Clamping range Rd / Rd	(+) 6-10 / 30 mm
Clamping range Fl / Fl	(+ / II) 30 / 30 mm

For T and cross connections

Part No.	308 030
Material	St/bare
Clamping range Rd / Fl	(+) 6-22 / 40 mm

For T, cross and parallel connections with clamping piece

For flexible connection of round conductors or for fixed earthing terminals while fixing in the formwork.



Part No.	308 035
Material	St/bare
Clamping range Rd / Rd	(+ / II) 6-22 / 6-10 mm
Clamping range Rd / Fl	(+) 6-22 / 40 mm

Pressure U-clamp

For T, cross and parallel connections.



Part No.	308 031
Material	St/bare
Clamping range Rd / Rd	(+ / II) 6-20 / 8-10 mm
Clamping range Rd / Fl	(+ / II) 6-20 / 30 x 3-4 mm
Clamping range Fl / Fl	(+ / II) 30 x 3-4 / 30 x 3-4 mm

Pressure U-clamp MAXI

For T, cross and parallel connections.



Part No.	308 036
Material	St/bare
Clamping range Rd / Rd	(+ / II) 20-32 / 8-10 mm
Clamping range Rd / Fl	(+ / II) 20-32 / 40 x 4-5 mm

U-bolt Clamp for large Diameters

Part No.	308 045
Material	St/bare
Clamping range Rd / Rd	(II) 16-48 / 6-10 mm
Clamping range Rd / Fl	(II) 16-48 / 30-40 mm

U-bolt Clamp for large Diameters, with two additional clamping pieces

For cross connection of round conductors (6-10 mm) or for fixing and connecting fixed earthing terminals.



Part No.	308 046
Material	St/bare
Clamping range Rd / Rd	(+ / II) 16-48 / 6-10 mm
Clamping range Rd / Fl	(II) 16-48 / 30-40 mm

MAXI MV Clamps

For T, cross and parallel connections.



Part No.	308 041	308 040
Material	St/tZn	St/bare
Clamping range Rd / Rd	(+ / II) 8-16 / 15-25 mm	(+ / II) 8-16 / 15-25 mm

Note: You will find our complete earthing / equipotential bonding and lightning protection portfolio in our Lightning Protection Main Catalogue.

Components for Foundation Earth Electrodes

Connecting Clamps for Foundation Earth Electrodes

Clamps to connect round and flat conductors in the concrete foundation.
For T, cross and parallel connections, without having to insert the conductor.

Part No.	308 120	308 129
Material	St/tZn	StSt
Clamping range Rd / Fl	(+) 10 / 30 mm	(+) 10 / 30 mm
Clamping range Fl / Fl	(+ / Il) 30 / 30 mm	(+ / Il) 30 / 30 mm



Spacers angled and reinforced / straight

For installing earth conductors in the foundation slab. With catch lug to stop the conductor from coming loose.

Part No.	290 001	290 002
Type	angled and reinforced	straight
Material	St/tZn	St/tZn
Support Fl	40 mm	40 mm
Support Rd	8-10 mm	8-10 mm
Length	300 mm	280 mm



Expansion Strap for Foundation Earth Electrodes

For leading the foundation earth electrode through the expansion joints of large foundations (several sections) so that it is not necessary to lead the earth electrode out of the base plate.

Part No.	308 150
Material of strap	StSt
Dimensions of strap (l x w x d)	approx. 700 x 30 x (4 x 1) mm
Material of block	polystyrene



Components for Ring Equipotential Bonding

Flat Strip / Round Conductor Holder with Thrust Piece

For wall mounting. Thrust piece with screw M8 for the installation of flat strip up to 11 mm and round conductor 6-10 mm.

Distance from wall 11 mm

Part No.	277 230	277 237	277 239
Material of conductor holder	St/tZn	Cu	StSt
Fixing	Ø13 and 7 x 20 mm	Ø13 and 7 x 20 mm	Ø13 and 7 x 20 mm
Material of screw	StSt	StSt	StSt



Distance from wall 15 mm

Part No.	277 240
Material of conductor holder	St/tZn
Fixing	7 x 15 mm
Material of screw	StSt



Connection Clamp

For universal connection to the ring equipotential bonding in case of St/tZn, copper or stainless steel (StSt).

Part No.	563 169
Conductor support Rd / Fl	Ø8-10 / 30 x 3 up to 11 mm
Material	StSt
Terminal cross section	2.5-95 mm ²



Clamping Piece

For connecting flat material to structural parts or, for example, connection clamps for steel girders (without a hole in the flat strip).

Part No.	380 129
Clamping range Fl	up to 30 x 4 mm
Material	StSt
Fixing	square hole 11 x 11 mm



Note: You will find our complete earthing / equipotential bonding and lightning protection portfolio in our Lightning Protection Main Catalogue.



DEHN protects.

BLITZDUCTOR
BXT ML2 BE
S 24

No. 920 224
protected lines 1/2
 U_c 33 V
 I_{imp} 2,5/9 kA (10/350)
 U_N 24 V
 I_L 0,75 A/45 °C
DEKRA 11ATEX0089 X
IECEx DEK 11.0032X
Ex nA IIC T4 Gc
TYPE 1P1

DEHNguard
DG MOD CI
275

DEHNguard
DG MOD CI
275

DEHN

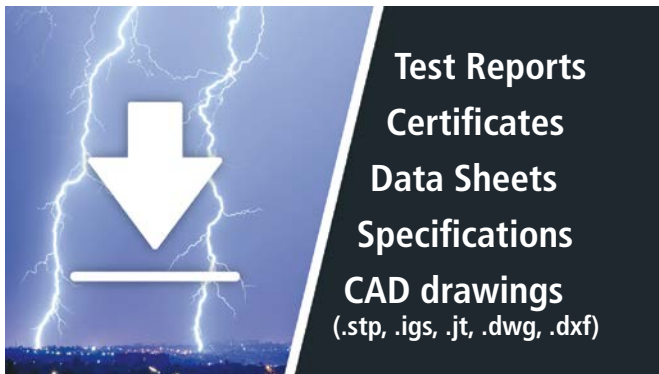

Product documentation / construction and CAD drawings

Creating planning and implementation drawings of lightning and surge protection systems requires detailed product documentation. Computer Aided Engineering (CAE) is based on construction and CAD drawings.

DEHN provides you with the following documents and drawings for collective download:

- Installation instructions / instructions for use
- Test reports
- Certificates
- Data sheets
- Specifications
- CAD drawings (file formats: .stp, .igs, .jt, .dwg, .dxf)

Supported product ranges:

- **Surge Protection Red/Line** and **Yellow/Line** (complete)
- **Lightning Protection / Earthing** (in part, rest in preparation)
- **Safety Equipment** (in part, rest in preparation)

Proceed as follows:

1. Registration under <https://www.dehn-international.com/user/register> or
2. Login under <https://www.dehn-international.com/user>
3. Add selected products to the shopping cart
4. Collective download of all components in the shopping cart

Collective download of certificates and test reports

Collective download of certificates and test reports from the notepad of our website is now possible. The procedure is the same as for the collective downloads of data sheets, etc.

Please note:

A certificate and/or test report is not available for all products.

More information at

www.dehn-international.com/en/lightning-protection

Data sheets, test reports, 3D data, etc. also on the internet:

<http://de.hn/enpd>

DEHNacademy online – E-Learning



Easy-to-understand lightning and surge protection Know-how at the click of a button

You want to gain basic knowledge in the field of lightning and surge protection? Our constantly growing portfolio of e-learning courses will help you become familiar with this topic.

Flexibly at work or at home. At your own pace. Completely free of charge. No download or installation required.

Brochures for Power Supply Systems

- DS125 E DEHNmid and DEHNtrack protect Medium Voltage Systems
 DS187 E DEHNsecure protects Direct Current Applications
 DS193 E For the protection of residential buildings – Combined arresters DEHNshield and DEHNshield Basic
 DS196 E Increased Safety for Switchgear Cabinets
 DS199 E DEHNshield: Universal solution for electromobility (pdf only)
 DS200 D/E DEHNguard PCB ... (FM) (pdf only)
 DS218 D/E DEHNcombo YPV SCI (pdf only)
 DS227 D/E DEHNguard SE H LI (pdf only)
 DS228 D/E DEHNcord (pdf only)
 DS237 D/E DEHNguard SE DC: Type 2 arrester for direct current applications (pdf only)
 DS247 D/E DEHNbloc Maxi CI: Type 1 lightning current arrester without additional backup fuse (pdf only)
 DS250 E Selection Matrix – Lightning current and surge arresters (pdf only)
 DS253 E Surge protection concept for LED street lights (pdf only)
 DS268 E DEHNguard SE H 1000 VA – Type 2 arrester for voltages up to 1000 V (pdf only)
 DS276 D/E DEHNcord R 3P – Type 2 arrester for electric shadings
 DS277 D/E DEHNguard M YPV ... FM – Universal type 2 arrester with high protective effect (pdf only)
 DS281 E DEHNshield Basic FM
 DS293 E Smart decoupling device VCSD
 DS297 E ACI Technology – Safety at the highest level (pdf only)
 DS302 E DEHNguard ME DC Y 950 FM – For maximum system and operational safety (pdf only)
 DS341 D/E EXFS Coaxial Connection Box (pdf only)
 DS350 D/E Retrofit now – Lightning current measuring system for wind turbines (pdf only)
 DS354 D/E Electromobility (pdf only)

Brochures for Information Technology Systems

- DS137 D/E DEHNgate: Coaxial Arresters (pdf only)
 DS143 E BLITZDUCTOR XT: Modular Lightning Current and Surge Arrester
 DS145 E DEHNrapid LSA: Modular lightning and surge protection
 DS150 E Yellow/Line Selection Guide
 DS164 E BLITZDUCTOR XTU: Universal lightning current and surge arrester (pdf only)
 DS188 E DEHNpatch / UGKF / DEHNgate (pdf only)
 DS204 D/E DEHNconnect SD2 (pdf only)
 DS225 E Safety for modern buildings (pdf only)
 DS235 D/E DEHNbox TC 180 (pdf only)
 DS248 D/E DEHNvario: Compact DIN rail mounted SPD (pdf only)
 DS260 D/E DEHNvario: Surge arrester for analogue camera systems (pdf only)
 DS278 D/E DEHNpatch outdoor (pdf only)
 DS283 D/E DEHNrecord Alert – Efficient servicing thanks to status reports of the SPDs (pdf only)
 DS361 E BLITZDUCTORconnect
 DS362 E DEHNbox TC B 180

General brochures

- DS103 E DEHN protects Wind Turbines
 DS104 E DEHN protects Cell Sites
 DS109 E DEHN protects Photovoltaic Systems
 DS113 E DEHN tests and analyses – DEHN Test Centre
 DS144 E DEHN protects Biogas Plants
 DS180 E DEHN protects the railway infrastructure
 DS197 E DEHN protects Safety Systems
 DS214 E DEHN protects Gas Industry Plants
 DS240 E Operation and maintenance of PV power plants (pdf only)
 DS243 E DEHN protects Smart Grids
 DS249 E DEHN protects Pipelines (pdf only)
 DS275 E DEHNdetect – Lightning current measuring system for detecting lightning events (pdf only)
 DS614 E Dynamic Times – Relax: DEHN protects residential buildings
 DS661 E When Lightning Strikes – What to do during a Thunderstorm
 DS709 E Design of Lightning Protection Systems – DEHNsupport Toolbox Software

DEHN CD/DVD

- DS702 Lightning Protection Guide on CD
 DS708 Animations on DVD
 Surge Protection – Power Supply Systems
 - DEHNguard SE DC
 - DEHNguard SE H LI
 - DEHNcube protects Photovoltaic Systems
 - DEHN protects Photovoltaic Systems
 Surge Protection – Information Technology Systems
 - DEHN protects Cell Sites
 - Protection of Ex (i) circuits
 - Maintenance strategy with BLITZDUCTOR XT
 - DEHNvario: Lightning and Surge Protection for electroacoustic Systems
 Surge Protection – Lightning Equipotential Bonding
 - Pipelines exposed to lightning strikes and overvoltage
 DEHN Screensaver

Contact

Information such as printed publications can be ordered from our
Customer Service Center: Phone: +49 9181 906 1547
 Fax: +49 9181 906 1444
 sales@dehn.de

DIN VDE standards, VDE-Verlag, Berlin**DIN VDE 0100-100:2009-06**

Low-voltage electrical installations Part 1:
Fundamental principles, assessment of general characteristics, definitions
(IEC 60364-1:2005, modified);
German implementation HD 60364-1:2008

DIN VDE 0100-410:2018-10

Low-voltage electrical installations – Part 4-41:
Protection for safety – Protection against electric shock
(IEC 60364-4-41:2005, modified);
German implementation HD 60364-4- 41:2007

DIN VDE 0100-443:2016-10

Low-voltage electrical installations – Part 4-44:
Protection for safety – Protection against voltage disturbances and elec-
tromagnetic disturbances – Clause 443: Protection against overvoltages
of atmospheric origin or due to switching
(IEC 60364-4-44:2007 + A1:2015, modified);
German implementation HD 60364-4-443:2016

DIN VDE 0100-534:2016-10

Low-voltage electrical installations – Part 5-53:
Selection and erection of electrical equipment – Isolation, switching and
control – Clause 534: Devices for protection against overvoltages;
[IEC 60364-5-53:2001/A2:2015 (Clause 534), modified];
German implementation HD 60364-5-534:2016

DIN VDE 0100-540:2012-06

Low-voltage electrical installations – Part 5-54:
Selection and erection of electrical equipment – Earthing arrangements,
protective conductors and protective bonding conductors
(IEC 60364-5-54:2011);
German implementation HD 60364-5-54:2011

DIN VDE 0100-717:2010-10

Low-voltage electrical installations – Part 7-717:
Requirements for special installations or locations – Mobile or transport-
able units (IEC 60364-7-717:2009, modified);
German implementation HD 60364-7-717:2010

DIN VDE 0618-1:1989-08

Equipment for equipotential bonding; equipotential bonding bush for
main equipotential bonding

DIN V VDE V 0800-2:2011-06

Information technology; Equipotential bonding and earthing (additional
specifications)

DIN EN 50178

DIN VDE 0160:1998-04
Electronic equipment for use in power installations;
German version EN 50178:1997

DIN EN 60060-1

DIN VDE 0432-1:2011-10
High voltage test techniques – Part 1:
General specifications and test requirements (IEC 60060-1:2010);
German version EN 60060-1:2010

DIN EN 60099-1

DIN VDE 0675-1:2000-08
Surge arresters – Part 1: Non-linear resistor type gapped surge arresters
for a.c. systems (IEC 60099-1:1991)
German version EN 60099-1:1994 + A1:1999

DIN EN 60664-1

DIN VDE 0110-1:2019-01
Insulation coordination for equipment within low-voltage systems – Part 1:
Principles, requirements and tests (IEC 60664-1:2007)
German version EN 60664-1:2007

DIN EN 60728-11

VDE 0855-1:2019-02
Cable networks for television signals, sound signals and interactive
services – Part 11: Safety (IEC 60728-11:2010);
German version EN 60728-11:2010

DIN EN 61643-11

VDE 0675-6-11:2019-03
Low-voltage surge protective devices – Part 11:
Surge protective devices connected to low-voltage power systems;
Requirements and tests (IEC 61643-11:2011, modified);
German version EN 61643-11:2012

DIN EN 62305-1

VDE 0185-305-1:2011-10
Protection against lightning – Part 1:
General principles (IEC 62305-1:2010, modified);
German version EN 62305-1:2011

DIN EN 62305-2

Protection against lightning – Part 2:
Risk management (IEC 62305-2:2010, modified);
German version EN 62305-2:2012

DIN EN 62305-3

Protection against lightning – Part 3:
Physical damage to structures and live hazard
(IEC 62305-3:2010, modified);
German version EN 62305-3:2011

DIN EN 62305-4

VDE 0185-305-4:2011-10
Protection against lightning – Part 4: Electrical and electronic systems
within structures (IEC 62305-4:2010, modified);
German version EN 62305-4:2011

DIN EN 62561-1

VDE 0185-561-1:2017-12
Lightning Protection System Components (LPSC) – Part 1:
Requirements for connection components (IEC 62561-1:2017, modified);
German version EN 62561-1:2017

DIN 18014:2014-03

Foundation earth electrode – Planning, execution and documentation

IEC 60664-1:2007-04

Insulation coordination for equipment within low-voltage systems;
part 1: principles, requirements and tests

IEC 61643-11:2011-03

Low-voltage surge protective devices – Part 11: Surge protective devices connected to low-voltage power distribution systems – Requirements and testing methods

IEC 61643-21:2013-07

Low voltage surge protective devices – Part 21: Surge protective devices connected to telecommunications and signalling networks; Performance requirements and testing methods

IEC 62305-1:2010-12

Protection against lightning; Part 1:
General principles

IEC 62305-2:2010-12

Protection against lightning; Part 2:
Risk management

IEC 62305-3:2010-12

Protection against lightning – Part 3:
Physical damage to structures and life hazard

IEC 62305-4:2010-12

Protection against lightning – Part 4:
Electrical and electronic systems within structures

Books

Landers E.U., Zahlmann P.:

“EMV – Blitzschutz von elektrischen und elektronischen Systemen in baulichen Anlagen – Risiko-Management, Planen und Ausführen nach den neuen Normen der Reihe VDE 0185- 305-x (VDE 0185-305-x)”

3. vollständig überarbeitete Auflage 2013,

[EMC-based lightning protection for electrical and electronic systems in structures – Risk management, design and installation according to the new standard series IN VDE 0185-305-x (VDE 0185-305-x),

3rd completely revised edition of 2013],

VDE series volume No. 185, Berlin-Offenbach: VDE Verlag GmbH,

ISBN 978-3-8007-3399-6

DEHN SE + Co KG

Lightning Protection Guide,

3rd edition 2015,

ISBN 978-3-9813770-1-9

VG standards, Beuth-Verlag GmbH**VG 95 372:2018-06**

Electromagnetic Compatibility (EMC) including Electromagnetic Pulse (EMP) and Lightning Protection – Survey

VG 95 371-10:2018-02

Electromagnetic compatibility (EMC) including electromagnetic pulse (EMP) and lightning protection – Fundamentals – Part 10: Threat levels for NEMP and lightning

Supplement 1:2012-02, Supplement 2:2012-02

VG 96 907-1:2013-01

Nuclear Electromagnetic Pulse (NEMP) and lightning protection – Design guidelines and protective devices – Part 1: Fundamentals

Further standards

Elektrische Überbrückung bei Rohrtrennungen

[Electrical bridging of separate pipe sections]

ZfGW-Verlag GmbH, Frankfurt.

AfK-Empfehlung Nr. 5:2014-02

Kathodischer Korrosionsschutz in Verbindung mit explosionsgefährdeten Bereichen.

[AfK recommendation No. 5:2010-07, Cathodic corrosion protection in connection with potentially explosive atmospheres]

ZfGW-Verlag GmbH, Frankfurt.

KTA 2206/2009-11:

Auslegung von Kernkraftwerken gegen Blitzeinwirkung.

[Protection for nuclear power plants against lightning effects]

Part No. / GTIN* / PG / Weight / PU / SU / Page

Part No.	GTIN*	PG	Weight	PU	SU	Page
106 310	096813	01 01 01 06	100 g	20	pc(s)	225
106 314	136304	04 02 08 50	100 g	1	pc(s)	225
106 329	107182	01 01 01 06	143 g	1	pc(s)	225
200 039	129283	01 04 01 04	40 g	1	pc(s)	213
277 230	110984	01 05 01 04	120 g	25	pc(s)	263
277 237	110991	01 05 01 04	126 g	25	pc(s)	263
277 239	111004	01 05 01 04	117 g	25	pc(s)	263
277 240	022577	01 05 01 04	167 g	25	pc(s)	263
290 001	027909	03 01 01 01	326 g	25	pc(s)	263
290 002	027893	03 01 01 01	89 g	50	pc(s)	263
308 025	035881	03 01 01 01	100 g	50	pc(s)	262
308 026	035874	03 01 01 01	107 g	25	pc(s)	262
308 030	030749	03 01 01 01	125 g	25	pc(s)	262
308 031	136571	03 01 01 01	230 g	25	pc(s)	262
308 035	123472	03 01 01 01	165 g	25	pc(s)	262
308 036	136588	03 01 01 01	266 g	25	pc(s)	262
308 040	055902	03 01 01 01	450 g	20	pc(s)	262
308 041	056411	03 01 01 01	471 g	20	pc(s)	262
308 045	124455	03 01 01 01	262 g	25	pc(s)	262
308 046	124462	03 01 01 01	288 g	25	pc(s)	262
308 120	099258	03 01 01 01	134 g	25	pc(s)	263
308 129	099265	03 01 01 01	131 g	25	pc(s)	263
308 150	106970	03 01 01 01	682 g	1	pc(s)	263
308 403	070509	04 02 10 01	26 g	10	pc(s)	231
308 404	070516	04 02 10 01	32 g	10	pc(s)	231
308 405	070523	04 02 10 01	37 g	10	pc(s)	231
308 406	070530	04 02 10 01	49 g	10	pc(s)	231
308 407	070547	04 02 10 01	60 g	10	pc(s)	231
308 408	070554	04 02 10 01	73 g	10	pc(s)	231
308 411	070578	04 02 10 01	56 g	5	pc(s)	231
308 421	070561	04 02 10 50	974 g	10	pc(s)	231
308 425	058798	04 02 10 01	19 g	10	pc(s)	231
380 129	150416	01 04 01 02	100 g	50	pc(s)	263
416 411	032545	03 07 01 01	266 g	1	pc(s)	225
472 021	027879	01 05 01 03	866 g	1	pc(s)	261
472 022	030305	01 05 01 03	588 g	1	pc(s)	261
472 023	030312	01 05 01 03	507 g	1	pc(s)	261
472 024	034495	01 05 01 03	677 g	1	pc(s)	261
472 109	074477	01 05 01 03	604 g	1	pc(s)	261
472 119	074484	01 05 01 03	740 g	1	pc(s)	261
472 129	074491	01 05 01 03	841 g	1	pc(s)	261
472 139	074507	01 05 01 03	1,1 kg	1	pc(s)	261
472 201	089631	01 06 01 01	66 g	1	pc(s)	260
472 202	147331	01 06 01 01	70 g	1	pc(s)	260
472 207	090927	01 05 01 03	964 g	1	pc(s)	260
472 209	090934	01 05 01 03	1.01 kg	1	pc(s)	260
472 210	096790	01 06 01 01	92 g	1	pc(s)	260
472 217	090941	01 05 01 03	1.35 kg	1	pc(s)	260
472 219	090958	01 05 01 03	1.41 kg	1	pc(s)	260
472 227	096424	01 05 01 03	1.14 kg	1	pc(s)	260
472 229	096431	01 05 01 03	1.18 kg	1	pc(s)	260
472 237	096448	01 05 01 03	1,53 kg	1	pc(s)	260
472 239	096455	01 05 01 03	1.59 kg	1	pc(s)	260
472 269	096462	01 05 01 03	322 g	1	pc(s)	260
472 279	090972	01 05 01 03	285 g	1	pc(s)	260
472 289	090989	01 05 01 03	366 g	1	pc(s)	260
472 299	096479	01 05 01 03	403 g	1	pc(s)	260
472 309	157170	01 05 01 03	226 g	1	pc(s)	261

Part No.	GTIN*	PG	Weight	PU	SU	Page
472 319	157187	01 05 01 03	267 g	1	pc(s)	261
472 329	157194	01 05 01 03	307 g	1	pc(s)	261
472 339	157200	01 05 01 03	348 g	1	pc(s)	261
472 349	157217	01 05 01 03	387 g	1	pc(s)	261
540 200	113039	01 05 01 02	136 g	10	pc(s)	213
540 801	115460	01 05 01 05	503 g	1	pc(s)	254
540 803	115477	01 05 01 05	566 g	1	pc(s)	254
540 805	128873	01 05 01 05	766 g	1	pc(s)	254
540 810	115484	01 05 01 05	550 g	1	pc(s)	254
540 821	123724	01 05 01 05	249 g	1	pc(s)	254
540 901	076525	01 05 01 02	6.28 kg	1	pc(s)	254
563 010	027800	01 05 01 03	469 g	1	pc(s)	258
563 011	027732	01 05 01 03	13 g	200	pc(s)	259
563 012	027749	01 05 01 03	63 g	25	pc(s)	259
563 013	027756	01 05 01 03	32 g	100	pc(s)	259
563 014	027787	01 05 01 03	11 g	50	pc(s)	259
563 015	027794	01 05 01 03	59 g	10	pc(s)	259
563 016	027763	01 05 01 03	166 g	10	pc(s)	259
563 017	027770	01 05 01 03	370 g	10	pc(s)	259
563 018	083585	01 05 01 03	672 g	10	pc(s)	259
563 019	096998	01 05 01 03	65 g	25	pc(s)	259
563 020	027817	01 05 01 03	476 g	1	pc(s)	258
563 030	027824	01 05 01 03	444 g	1	pc(s)	258
563 040	082861	01 05 01 03	460 g	1	pc(s)	258
563 050	054707	01 05 01 03	231 g	20	pc(s)	257
563 105	027831	01 05 01 03	210 g	10	pc(s)	257
563 169	104839	01 05 01 04	76 g	50	pc(s)	263
563 200	056558	01 05 01 03	410 g	1	pc(s)	257
563 201	101234	01 05 01 03	397 g	1	pc(s)	257
723 199	151703	05 03 01 01	750 g	1	pc(s)	256
900 050	107496	04 01 01 14	507 g	1	pc(s)	48
900 070	504521 ¹⁾	04 01 01 05	509 g	1	pc(s)	32
900 071	504545 ¹⁾	04 01 01 05	562 g	1	pc(s)	32
900 075	504538 ¹⁾	04 01 01 05	511 g	1	pc(s)	32
900 076	504552 ¹⁾	04 01 01 05	564 g	1	pc(s)	32
900 120	109377	04 01 01 13	873 g	1	pc(s)	46
900 220	106734	04 01 01 11	699 g	1	pc(s)	41
900 222	102521	04 01 01 13	331 g	1	pc(s)	46
900 230	153783	04 01 01 07	1.49 kg	1	pc(s)	33
900 255	125773	04 01 01 09	194 g	1	pc(s)	36
900 261	094352	04 01 02 16	158 g	1	pc(s)	101
900 262	072572	04 01 02 16	158 g	1	pc(s)	101
900 263	094369	04 01 02 16	194 g	1	pc(s)	101
900 264	073661	04 01 02 16	157 g	1	pc(s)	101
900 270	106703	04 01 02 16	223 g	1	pc(s)	101
900 271	106710	04 01 02 16	224 g	1	pc(s)	101
900 411	107205	04 01 01 50	54 g	1	pc(s)	126
900 417	120419	04 01 01 50	66 g	1	pc(s)	126
900 418	159884	04 01 02 50	49 g	1	pc(s)	126
900 419	156821	04 01 02 50	39 g	1	pc(s)	126
900 429	159891	04 01 02 50	59 g	1	pc(s)	126
900 430	157286	04 01 02 05	59 g	1	pc(s)	78
900 431	310827	04 01 02 05	46 g	1	pc(s)	78
900 432	157309	04 01 02 05	61 g	1	pc(s)	78
900 433	157316	04 01 02 05	48 g	1	pc(s)	78
900 435	292963	04 01 02 05	54 g	1	pc(s)	80
900 439	436053	04 01 02 05	102 g	1	pc(s)	78
900 443	394322	04 01 02 05	785 g	1	pc(s)	79
900 445	280380	04 01 02 05	58 g	1	pc(s)	79

Part No. / GTIN* / PG / Weight / PU / SU / Page

Part No.	GTIN*	PG	Weight	PU	SU	Page
900 446	292970	04 01 02 05	49 g	1	pc(s)	79
900 447	282216	04 01 02 05	130 g	1	pc(s)	80
900 448	293007	04 01 02 05	113 g	1	pc(s)	80
900 449	320031	04 01 02 05	129 g	1	pc(s)	80
900 450	157989	04 01 02 19	77 g	1	pc(s)	64
900 455	157996	04 01 02 19	143 g	1	pc(s)	64
900 458	320574	04 01 02 19	76 g	1	pc(s)	64
900 459	320581	04 01 02 19	143 g	1	pc(s)	64
900 460	244146	04 01 02 50	37 g	1	pc(s)	126
900 461	260559	04 01 01 50	64 g	1	pc(s)	127
900 462	260566	04 01 01 50	81 g	1	pc(s)	127
900 471	067547	04 01 03 04	22 g	1	pc(s)	114
900 588	323933	04 01 04 03	31 g	1	pc(s)	121
900 589	109339	04 01 04 03	20 g	1	pc(s)	121
900 595	078208	04 01 04 03	58 g	1	pc(s)	125
900 610	048553	04 01 04 03	19 g	1	pc(s)	124
900 611	048560	04 01 04 03	38 g	1	pc(s)	125
900 612	069428	04 01 04 03	288 g	1	pc(s)	125
900 614	072534	04 01 04 03	830 g	1	pc(s)	125
900 615	086562	04 01 04 03	14 g	1	pc(s)	124
900 617	086593	04 01 04 03	9 g	1	pc(s)	124
900 760	156135	04 01 02 20	274 g	1	pc(s)	76
900 761	156142	04 01 02 20	294 g	1	pc(s)	76
900 762	156159	04 01 02 20	294 g	1	pc(s)	76
900 765	156166	04 01 02 20	512 g	1	pc(s)	76
900 766	156173	04 01 02 20	545 g	1	pc(s)	76
900 767	156180	04 01 02 20	551 g	1	pc(s)	76
900 768	156197	04 01 02 20	556 g	1	pc(s)	76
900 780	156203	04 01 02 20	368 g	1	pc(s)	76
900 781	156210	04 01 02 20	390 g	1	pc(s)	76
900 782	156227	04 01 02 20	389 g	1	pc(s)	76
900 785	156234	04 01 02 20	693 g	1	pc(s)	76
900 786	156241	04 01 02 20	726 g	1	pc(s)	76
900 787	156258	04 01 02 20	732 g	1	pc(s)	76
900 788	156265	04 01 02 20	736 g	1	pc(s)	76
900 813	090842	04 01 04 03	67 g	1	pc(s)	125
900 814	091115	04 01 04 03	114 g	1	pc(s)	125
900 815	087996	04 01 04 03	29 g	1	pc(s)	124
900 839	153059	04 01 04 03	14 g	1	pc(s)	125
900 848	107816	04 01 04 03	34 g	1	pc(s)	124
900 910	155046	04 01 02 10	426 g	1	pc(s)	91
900 920	155053	04 01 02 10	617 g	1	pc(s)	91
900 945	425118	04 01 02 10	230 g	1	pc(s)	92
902 314	151031	04 01 04 02	786 g	1	pc(s)	122
902 315	125759	04 01 04 02	1.83 kg	1	pc(s)	122
902 316	151048	04 01 04 02	1.92 kg	1	pc(s)	123
902 317	151055	04 01 04 02	5 g	1	pc(s)	123
902 471	108943	04 01 04 02	1.79 kg	1	pc(s)	123
902 472	108950	04 01 04 02	2.39 kg	1	pc(s)	123
902 485	045767	04 01 04 02	612 g	1	pc(s)	122
906 055	071513	04 02 10 02	1.00 kg	1	pc(s)	234
906 058	091658	04 02 10 02	899 g	1	pc(s)	234
906 100	106598	04 02 04 03	3.40 kg	1	pc(s)	201
906 101	106604	04 02 04 03	4.97 kg	1	pc(s)	201
906 102	106611	04 02 04 03	5.70 kg	1	pc(s)	201
906 103	106628	04 02 04 03	7.65 kg	1	pc(s)	201
907 208	107373	04 02 04 50	2 g	1	pc(s)	200
907 214	100879	04 02 04 02	66 g	10	pc(s)	200
907 216	106680	04 02 04 02	66 g	10	pc(s)	200

Part No.	GTIN*	PG	Weight	PU	SU	Page
907 217	107342	04 02 04 50	2 g	1	pc(s)	200
907 218	107588	04 02 04 50	2 g	1	pc(s)	199
907 219	107595	04 02 04 50	2 g	1	pc(s)	199
907 400	107557	04 02 04 01	65 g	10	pc(s)	197
907 401	107564	04 02 04 01	69 g	10	pc(s)	197
907 421	107618	04 02 04 01	4 g	10	pc(s)	197
907 422	107625	04 02 04 01	4 g	10	pc(s)	197
907 423	107632	04 02 04 01	4 g	10	pc(s)	197
907 424	107649	04 02 04 01	4 g	10	pc(s)	197
907 425	107656	04 02 04 01	3 g	10	pc(s)	197
907 430	107670	04 02 04 01	4 g	10	pc(s)	198
907 441	107694	04 02 04 01	4 g	10	pc(s)	198
907 442	107700	04 02 04 01	3 g	10	pc(s)	198
907 443	107717	04 02 04 01	4 g	10	pc(s)	198
907 444	107724	04 02 04 01	3 g	10	pc(s)	198
907 445	118461	04 02 04 01	3 g	10	pc(s)	198
907 470	107663	04 02 04 01	4 g	10	pc(s)	198
907 496	150683	04 02 04 50	13 g	10	pc(s)	199
907 497	112995	04 02 04 50	16 g	1	pc(s)	199
907 498	107540	04 02 04 50	10 g	1	pc(s)	199
907 499	107533	04 02 04 50	45 g	10	pc(s)	199
907 991	112988	04 02 04 50	181 g	1	pc(s)	203
907 993	048584	04 02 04 50	60 g	1	pc(s)	203
907 994	033511	04 02 04 50	105 g	1	pc(s)	202
907 995	033528	04 02 04 50	228 g	1	pc(s)	202
907 996	033535	04 02 04 50	60 g	1	pc(s)	203
907 997	033542	04 02 04 50	48 g	1	pc(s)	202
908 010	148512	04 01 02 17	42 g	1	pc(s)	74
908 011	148482	04 01 02 17	37 g	1	pc(s)	74
908 012	148505	04 01 02 17	40 g	1	pc(s)	74
908 013	148536	04 01 02 17	57 g	1	pc(s)	74
908 014	148529	04 01 02 17	49 g	1	pc(s)	74
908 015	148543	04 01 02 17	60 g	1	pc(s)	74
908 070	148499	04 01 02 17	113 g	1	pc(s)	74
908 074	148567	04 01 02 17	123 g	1	pc(s)	74
908 076	148581	04 01 02 17	130 g	1	pc(s)	74
908 090	148550	04 01 02 17	117 g	1	pc(s)	74
908 094	148574	04 01 02 17	126 g	1	pc(s)	74
908 096	148598	04 01 02 17	134 g	1	pc(s)	74
908 190	148604	04 01 02 17	219 g	1	pc(s)	72
908 192	148628	04 01 02 17	238 g	1	pc(s)	72
908 195	148611	04 01 02 17	225 g	1	pc(s)	73
908 197	148635	04 01 02 17	243 g	1	pc(s)	73
908 203	148642	04 01 02 17	225 g	1	pc(s)	73
908 204	148666	04 01 02 17	259 g	1	pc(s)	73
908 208	148659	04 01 02 17	230 g	1	pc(s)	74
908 209	148673	04 01 02 17	266 g	1	pc(s)	74
908 214	267961	04 01 02 17	304 g	1	pc(s)	73
908 219	267978	04 01 02 17	311 g	1	pc(s)	73
908 300	148680	04 01 02 17	303 g	1	pc(s)	70
908 301	148727	04 01 02 17	363 g	1	pc(s)	70
908 305	148697	04 01 02 17	310 g	1	pc(s)	71
908 306	148734	04 01 02 17	370 g	1	pc(s)	71
908 314	148703	04 01 02 17	339 g	1	pc(s)	70
908 319	148710	04 01 02 17	347 g	1	pc(s)	71
908 340	148840	04 01 02 17	386 g	1	pc(s)	71
908 341	148864	04 01 02 17	423 g	1	pc(s)	71
908 342	148765	04 01 02 17	448 g	1	pc(s)	71
908 343	148789	04 01 02 17	399 g	1	pc(s)	72
908 344	148802	04 01 02 17	430 g	1	pc(s)	72

Part No. / GTIN* / PG / Weight / PU / SU / Page

Part No.	GTIN*	PG	Weight	PU	SU	Page
908 345	148857	04 01 02 17	394 g	1	pc(s)	72
908 346	148871	04 01 02 17	432 g	1	pc(s)	72
908 347	148772	04 01 02 17	456 g	1	pc(s)	72
908 348	148796	04 01 02 17	406 g	1	pc(s)	72
908 349	148819	04 01 02 17	438 g	1	pc(s)	72
908 350	148741	04 01 02 17	373 g	1	pc(s)	71
908 351	148826	04 01 02 17	319 g	1	pc(s)	71
908 355	148758	04 01 02 17	380 g	1	pc(s)	71
908 356	148833	04 01 02 17	325 g	1	pc(s)	71
908 505	228139	04 01 01 15	861 g	1	pc(s)	35
908 506	228146	04 01 01 15	882 g	1	pc(s)	35
909 230	117686	04 01 03 03	190 g	1	pc(s)	115
909 240	117693	04 01 03 03	194 g	1	pc(s)	115
909 250	132566	04 01 03 03	1.10 kg	1	pc(s)	116
909 251	132573	04 01 03 03	1.00 kg	1	pc(s)	116
909 300	117723	04 02 07 01	234 g	1	pc(s)	216
909 310	117747	04 02 07 01	212 g	1	pc(s)	217
909 320	136885	04 02 07 01	215 g	1	pc(s)	217
909 321	126152	04 02 07 01	222 g	1	pc(s)	217
909 703	085664	04 02 08 02	233 g	1	pc(s)	223
909 704	105690	04 02 08 02	86 g	1	pc(s)	223
909 705	105706	04 02 08 02	283 g	1	pc(s)	223
909 706	362437	04 02 08 02	222 g	1	pc(s)	223
909 710	118942	04 02 08 01	114 g	1	pc(s)	222
909 711	118980	04 02 08 01	116 g	1	pc(s)	222
910 099	037298	04 02 10 02	38 g	1	pc(s)	234
910 200	144019	04 01 04 01	140 g	1	pc(s)	120
910 486	124479	04 03 01 50	130 g	1	pc(s)	177/238
910 499	157149	04 03 01 50	180 g	1	pc(s)	177/238
910 508	111363	04 03 01 03	800 g	1	pc(s)	242
910 511	111424	04 03 01 01	1.32 kg	1	pc(s)	199/242
910 512	323223	04 01 04 01	140 g	1	pc(s)	118
910 631	108196	04 01 01 11	114 g	1	pc(s)	42
910 641	093416	04 01 01 11	1 g	1	pc(s)	42
910 642	107878	04 01 01 11	80 g	1	pc(s)	42
910 652	114531	04 03 01 50	64 g	1	pc(s)	177/241
910 653	113008	04 03 01 02	1.06 kg	1	pc(s)	177/241
910 655	149250	04 03 01 02	835 g	1	pc(s)	177/241
910 694	350212	04 03 01 03	67 g	1	pc(s)	239
910 695	118959	04 03 01 03	180 g	1	pc(s)	177/238
910 696	149359	04 03 01 03	54 g	1	pc(s)	177/238
910 697	123717	04 03 01 50	31 g	1	Sa	175/238
910 698	337053	04 03 01 03	67 g	1	pc(s)	239
910 710	424678	04 03 01 03	52 g	1	pc(s)	236
910 797	428829	04 02 01 50	9 g	1	pc(s)	160/184
912 253	068360	04 01 03 01	563 g	1	pc(s)	109
912 254	073685	04 01 03 01	300 g	1	pc(s)	108
915 000	421271	04 01 07 01	860 g	1	pc(s)	117
915 001	421301	04 01 07 01	845 g	1	pc(s)	117
915 051	422247	04 01 07 01	820 g	1	pc(s)	118
917 900	150676	04 02 02 50	3 g	5	pc(s)	188
917 920	150560	04 02 02 02	32 g	1	pc(s)	186
917 921	150577	04 02 02 02	31 g	1	pc(s)	186
917 922	150584	04 02 02 02	31 g	1	pc(s)	186
917 940	150591	04 02 02 02	31 g	1	pc(s)	186
917 941	150607	04 02 02 02	31 g	1	pc(s)	186
917 942	150614	04 02 02 02	31 g	1	pc(s)	186
917 960	150638	04 02 02 02	32 g	1	pc(s)	187

Part No.	GTIN*	PG	Weight	PU	SU	Page
917 970	150621	04 02 02 02	31 g	1	pc(s)	186
917 977	151536	04 02 02 50	9 g	1	pc(s)	188
917 987	150645	04 02 02 02	30 g	1	pc(s)	186
917 988	150652	04 02 02 02	25 g	1	pc(s)	186
917 989	150669	04 02 02 02	30 g	1	pc(s)	186
918 401	074224	04 02 03 01	182 g	1	pc(s)	192
918 408	125292	04 02 03 01	110 g	1	pc(s)	192
918 409	146709	04 02 03 01	110 g	1	pc(s)	192
918 411	093133	04 02 03 01	99 g	1	pc(s)	192
918 420	094895	04 02 03 01	212 g	1	pc(s)	193
918 421	094901	04 02 03 01	118 g	1	pc(s)	193
918 422	149267	04 02 03 01	97 g	1	pc(s)	192
919 010	071612	04 02 10 01	13 g	10	pc(s)	232
919 011	071605	04 02 10 01	28 g	10	pc(s)	232
919 012	071599	04 02 10 01	40 g	1	pc(s)	232
919 013	071582	04 02 10 01	55 g	1	pc(s)	232
919 014	071575	04 02 10 01	5 g	10	pc(s)	232
919 015	071568	04 02 10 01	15 g	1	pc(s)	232
919 016	071551	04 02 10 01	481 g	1	pc(s)	232
919 030	103504	04 02 10 01	167 g	1	pc(s)	201/233
919 031	103511	04 02 10 01	2 g	20	pc(s)	201/233
919 032	103528	04 02 10 01	2 g	20	pc(s)	201/233
919 033	103535	04 02 10 01	5 g	20	pc(s)	201/233
919 034	103542	04 02 10 01	7 g	10	pc(s)	201/233
919 035	103559	04 02 10 01	12 g	10	pc(s)	201/233
919 036	103566	04 02 10 01	23 g	25	pc(s)	233
919 037	103573	04 02 10 01	50 g	50	pc(s)	233
919 038	103580	04 02 10 01	82 g	10	pc(s)	233
919 880	095090	04 02 02 50	5 g	25	pc(s)	188
920 211	120570	04 02 01 02	23 g	1	pc(s)	166
920 220	118331	04 02 01 02	36 g	1	pc(s)	166
920 222	118355	04 02 01 02	21 g	1	pc(s)	166
920 224	117785	04 02 01 02	37 g	1	pc(s)	166
920 225	118379	04 02 01 02	21 g	1	pc(s)	166
920 226	142121	04 02 01 02	23 g	1	pc(s)	166
920 240	118348	04 02 01 02	20 g	1	pc(s)	165
920 242	118362	04 02 01 02	21 g	1	pc(s)	165
920 243	126732	04 02 01 02	21 g	1	pc(s)	167
920 244	117792	04 02 01 02	21 g	1	pc(s)	165
920 245	118386	04 02 01 02	36 g	1	pc(s)	165
920 247	116078	04 02 01 02	43 g	1	pc(s)	165
920 249	127845	04 02 01 03	23 g	1	pc(s)	169
920 270	117549	04 02 01 02	22 g	1	pc(s)	166
920 271	117556	04 02 01 02	22 g	1	pc(s)	166
920 280	142138	04 02 01 05	22 g	1	pc(s)	174
920 288	137363	04 02 01 02	25 g	1	pc(s)	167
920 289	135840	04 02 01 02	22 g	1	pc(s)	167
920 296	340015	04 02 01 02	21 g	1	pc(s)	167
920 300	109179	04 02 01 01	34 g	1	pc(s)	161
920 301	109186	04 02 01 01	53 g	1	pc(s)	173
920 308	109209	04 02 01 02	22 g	1	pc(s)	176
920 309	109193	04 02 01 02	14 g	1	pc(s)	176
920 310	109124	04 02 01 02	25 g	1	pc(s)	162
920 314	261396	04 02 01 02	25 g	1	pc(s)	163
920 320	109032	04 02 01 02	24 g	1	pc(s)	163
920 322	109049	04 02 01 02	24 g	1	pc(s)	163
920 324	109056	04 02 01 02	38 g	1	pc(s)	163
920 325	109063	04 02 01 02	24 g	1	pc(s)	163
920 326	109070	04 02 01 02	24 g	1	pc(s)	163

Part No. / GTIN* / PG / Weight / PU / SU / Page

Part No.	GTIN*	PG	Weight	PU	SU	Page
920 327	109087	04 02 01 02	24 g	1	pc(s)	163
920 334	152229	04 02 01 02	23 g	1	pc(s)	165
920 336	118539	04 02 01 02	40 g	1	pc(s)	163
920 340	108967	04 02 01 02	23 g	1	pc(s)	163
920 342	108974	04 02 01 02	23 g	1	pc(s)	163
920 344	108981	04 02 01 02	37 g	1	pc(s)	163
920 345	108998	04 02 01 02	24 g	1	pc(s)	163
920 346	109001	04 02 01 02	24 g	1	pc(s)	163
920 347	109018	04 02 01 02	24 g	1	pc(s)	163
920 349	126404	04 02 01 03	25 g	1	pc(s)	169
920 350	109131	04 02 01 02	24 g	1	pc(s)	164
920 354	109148	04 02 01 02	24 g	1	pc(s)	164
920 362	120587	04 02 01 02	24 g	1	pc(s)	164
920 364	109155	04 02 01 02	25 g	1	pc(s)	164
920 370	109117	04 02 01 02	24 g	1	pc(s)	164
920 371	109094	04 02 01 02	24 g	1	pc(s)	164
920 375	109100	04 02 01 02	24 g	1	pc(s)	164
920 381	109025	04 02 01 05	23 g	1	pc(s)	174
920 383	126725	04 02 01 05	21 g	1	pc(s)	175
920 384	109162	04 02 01 05	22 g	1	pc(s)	174
920 388	137370	04 02 01 02	28 g	1	pc(s)	165
920 389	118447	04 02 01 02	30 g	1	pc(s)	165
920 395	118157	04 02 01 50	12 g	1	Sa	176
920 398	126572	04 02 01 50	6 g	1	Sa	176/238
920 538	125285	04 02 01 05	20 g	1	pc(s)	174
922 210	158214	04 02 07 03	138 g	1	pc(s)	220
922 220	433953	04 02 07 03	74 g	1	pc(s)	220
922 400	137349	04 02 07 03	220 g	1	pc(s)	220
923 019	033177	04 01 05 02	1.70 kg	1	pc(s)	247
923 021	036161	04 01 05 01	185 g	1	pc(s)	246
923 023	074262	04 01 05 01	185 g	1	pc(s)	246
923 025	110397	04 01 05 03	137 g	1	pc(s)	249
923 035	110403	04 01 05 03	163 g	1	pc(s)	249
923 060	038899	04 01 05 02	725 g	1	pc(s)	247
923 061	038905	04 01 05 02	750 g	1	pc(s)	247
923 062	038912	04 01 05 02	733 g	1	pc(s)	247
923 100	108325	04 01 05 02	289 g	1	pc(s)	248
923 101	108332	04 01 05 02	1.98 kg	1	pc(s)	249
923 110	092426	05 03 01 01	40 g	10	pc(s)	255
923 116	085978	05 03 01 01	42 g	10	pc(s)	256
923 117	093478	05 03 01 01	42 g	10	pc(s)	255
923 118	104969	05 03 01 01	38 g	10	pc(s)	256
923 119	104976	05 03 01 01	38 g	10	pc(s)	256
923 211	150904	04 01 05 03	109 g	1	pc(s)	249
923 214	150911	04 01 05 03	107 g	1	pc(s)	249
923 218	150928	04 01 05 03	99 g	1	pc(s)	249
923 222	150935	04 01 05 03	95 g	1	pc(s)	249
923 226	150942	04 01 05 03	92 g	1	pc(s)	249
923 230	150959	04 01 05 03	180 g	1	pc(s)	249
923 233	150966	04 01 05 03	174 g	1	pc(s)	249
923 236	150973	04 01 05 03	167 g	1	pc(s)	249
923 239	150980	04 01 05 03	162 g	1	pc(s)	249
923 242	150997	04 01 05 03	158 g	1	pc(s)	249
923 311	150775	04 01 05 03	105 g	1	pc(s)	249
923 314	150782	04 01 05 03	103 g	1	pc(s)	249
923 318	150799	04 01 05 03	101 g	1	pc(s)	249
923 322	150805	04 01 05 03	96 g	1	pc(s)	249
923 326	150812	04 01 05 03	91 g	1	pc(s)	249
923 330	150829	04 01 05 03	178 g	1	pc(s)	249
923 333	150836	04 01 05 03	172 g	1	pc(s)	249

Part No.	GTIN*	PG	Weight	PU	SU	Page
923 336	150843	04 01 05 03	168 g	1	pc(s)	249
923 339	150850	04 01 05 03	159 g	1	pc(s)	249
923 342	150867	04 01 05 03	158 g	1	pc(s)	249
923 348	150874	04 01 05 03	144 g	1	pc(s)	249
923 356	150881	04 01 05 03	262 g	1	pc(s)	249
923 362	150898	04 01 05 03	244 g	1	pc(s)	249
923 401	237766	04 01 06 04	12.15 kg	1	pc(s)	252
924 017	045934	04 02 09 01	30 g	1	pc(s)	227
924 328	100008	04 01 03 50	15 g	1	pc(s)	110
924 329	099234	04 01 03 50	12 g	1	pc(s)	110
924 335	071773	04 01 03 02	122 g	1	pc(s)	111
924 336	071681	04 01 03 50	13 g	1	pc(s)	111
924 350	076709	04 01 03 04	34 g	1	pc(s)	112
924 370	081321	04 01 03 02	71 g	1	pc(s)	110
924 389	073692	04 01 03 02	36 g	1	pc(s)	113
924 395	076334	04 01 03 02	67 g	1	pc(s)	113
924 396	091016	04 01 03 02	32 g	1	pc(s)	113
925 001	047365	04 02 07 02	10 g	1	pc(s)	218
926 220	127012	04 02 01 04	21 g	1	pc(s)	171
926 222	127029	04 02 01 04	21 g	1	pc(s)	171
926 224	127036	04 02 01 04	21 g	1	pc(s)	171
926 225	127043	04 02 01 04	21 g	1	pc(s)	171
926 227	127067	04 02 01 04	21 g	1	pc(s)	171
926 240	127074	04 02 01 04	21 g	1	pc(s)	172
926 242	127081	04 02 01 04	21 g	1	pc(s)	172
926 244	127098	04 02 01 04	21 g	1	pc(s)	172
926 245	127104	04 02 01 04	21 g	1	pc(s)	172
926 246	127111	04 02 01 04	21 g	1	pc(s)	172
926 247	127128	04 02 01 04	21 g	1	pc(s)	172
926 270	127135	04 02 01 04	21 g	1	pc(s)	172
926 271	127142	04 02 01 04	21 g	1	pc(s)	172
926 275	129351	04 02 01 04	21 g	1	pc(s)	172
926 304	157125	04 02 01 01	45 g	1	pc(s)	161
926 320	127159	04 02 01 04	22 g	1	pc(s)	170
926 322	127166	04 02 01 04	22 g	1	pc(s)	170
926 324	127173	04 02 01 04	21 g	1	pc(s)	170
926 325	127180	04 02 01 04	22 g	1	pc(s)	170
926 327	127203	04 02 01 04	22 g	1	pc(s)	170
926 340	127210	04 02 01 04	22 g	1	pc(s)	171
926 342	127227	04 02 01 04	22 g	1	pc(s)	171
926 344	127234	04 02 01 04	22 g	1	pc(s)	171
926 345	127241	04 02 01 04	22 g	1	pc(s)	171
926 347	127265	04 02 01 04	21 g	1	pc(s)	171
926 370	127272	04 02 01 04	22 g	1	pc(s)	171
926 371	127289	04 02 01 04	22 g	1	pc(s)	172
926 375	129382	04 02 01 04	22 g	1	pc(s)	172
927 010	410114	04 02 01 06	14 g	1	pc(s)	158
927 022	410121	04 02 01 06	14 g	1	pc(s)	158
927 024	410138	04 02 01 06	14 g	1	pc(s)	158
927 025	410145	04 02 01 06	14 g	1	pc(s)	158
927 042	410152	04 02 01 06	14 g	1	pc(s)	159
927 044	410169	04 02 01 06	14 g	1	pc(s)	159
927 045	410176	04 02 01 06	14 g	1	pc(s)	159
927 070	410183	04 02 01 06	14 g	1	pc(s)	159
927 071	410190	04 02 01 06	14 g	1	pc(s)	159
927 084	410206	04 02 01 06	14 g	1	pc(s)	159
927 210	405585	04 02 01 06	34 g	1	pc(s)	157
927 222	405592	04 02 01 06	34 g	1	pc(s)	157
927 224	405608	04 02 01 06	34 g	1	pc(s)	157

Part No.	GTIN*	PG	Weight	PU	SU	Page
927 225	405615	04 02 01 06	34 g	1	pc(s)	157
927 242	405622	04 02 01 06	34 g	1	pc(s)	157
927 244	405639	04 02 01 06	34 g	1	pc(s)	157
927 245	405646	04 02 01 06	34 g	1	pc(s)	157
927 270	405653	04 02 01 06	34 g	1	pc(s)	157
927 271	405660	04 02 01 06	34 g	1	pc(s)	158
927 284	405677	04 02 01 06	40 g	1	pc(s)	158
927 910	411739	04 02 02 06	33 g	1	pc(s)	183
927 922	411951	04 02 02 06	33 g	1	pc(s)	183
927 924	411968	04 02 02 06	33 g	1	pc(s)	183
927 925	411975	04 02 02 06	33 g	1	pc(s)	183
927 942	411777	04 02 02 06	33 g	1	pc(s)	183
927 944	411784	04 02 02 06	33 g	1	pc(s)	183
927 945	411807	04 02 02 06	33 g	1	pc(s)	183
927 970	411982	04 02 02 06	33 g	1	pc(s)	183
927 971	411999	04 02 02 06	33 g	1	pc(s)	183
927 984	412002	04 02 02 06	33 g	1	pc(s)	184
928 430	261389	04 02 03 02	110 g	1	pc(s)	190
928 440	280809	04 02 03 02	134 g	1	pc(s)	190
929 010	039940	04 02 08 01	68 g	1	pc(s)	222
929 039	135185	04 02 08 03	24 g	1	pc(s)	224
929 042	091030	04 02 08 03	39 g	1	pc(s)	224
929 043	091047	04 02 08 03	90 g	1	pc(s)	224
929 044	091054	04 02 08 03	86 g	1	pc(s)	224
929 045	091061	04 02 08 03	266 g	1	pc(s)	224
929 047	091085	04 02 08 03	467 g	1	pc(s)	224
929 095	113398	04 02 08 50	90 g	1	pc(s)	225
929 096	107212	04 02 08 50	203 g	1	pc(s)	225
929 100	102170	04 02 06 01	244 g	1	pc(s)	212
929 121	118935	04 02 06 01	109 g	1	pc(s)	212
929 126	242258	04 02 06 01	96 g	1	pc(s)	212
929 146	157156	04 02 08 03	471 g	1	pc(s)	224
929 148	157163	04 02 08 03	448 g	1	pc(s)	224
929 199	103313	04 02 06 50	350 g	1	pc(s)	213
929 200	344082	04 02 06 50	6 g	1	pc(s)	213
929 200	344082	04 02 06 50	6 g	1	pc(s)	225
929 221	342866	04 02 06 01	606 g	1	pc(s)	211
929 335	228672	04 02 06 50	1.38 kg	1	pc(s)	213
929 497	104143	04 02 08 50	2 g	1	pc(s)	225
929 498	104136	04 02 08 50	2 g	1	pc(s)	225
929 499	104129	04 02 08 50	2 g	1	pc(s)	225
929 921	098169	04 02 05 01	218 g	1	pc(s)	206
929 941	098152	04 02 05 01	173 g	1	pc(s)	206
929 950	137387	04 02 05 03	222 g	1	pc(s)	208
929 951	137394	04 02 05 03	222 g	1	pc(s)	208
929 960	098145	04 02 05 01	172 g	1	pc(s)	207
929 961	101784	04 02 05 02	169 g	1	pc(s)	207
929 962	101791	04 02 05 02	169 g	1	pc(s)	207
929 963	101807	04 02 05 02	172 g	1	pc(s)	207
929 964	101814	04 02 05 02	169 g	1	pc(s)	207
929 965	360778	04 02 05 01	171 g	1	pc(s)	207
929 969	127418	04 02 05 03	255 g	1	pc(s)	208
929 970	127425	04 02 05 03	248 g	1	pc(s)	208
929 971	120761	04 02 05 01	272 g	1	pc(s)	207
929 982	098695	04 02 05 50	36 g	1	pc(s)	208
929 984	098688	04 02 05 50	30 g	1	pc(s)	208
929 996	098244	04 02 05 50	13 g	1	pc(s)	208
941 110	137899	04 01 01 04	275 g	1	pc(s)	31
941 115	289208	04 01 01 04	285 g	1	pc(s)	31

Part No.	GTIN*	PG	Weight	PU	SU	Page
941 116	373235	04 01 01 04	285 g	1	pc(s)	31
941 200	138209	04 01 01 04	250 g	1	pc(s)	30
941 205	289185	04 01 01 04	260 g	1	pc(s)	30
941 206	373839	04 01 01 04	260 g	1	pc(s)	30
941 300	133556	04 01 01 04	386 g	1	pc(s)	28
941 305	275317	04 01 01 04	361 g	1	pc(s)	28
941 306	328068	04 01 01 04	362 g	1	pc(s)	28
941 310	131798	04 01 01 04	480 g	1	pc(s)	29
941 315	275324	04 01 01 04	448 g	1	pc(s)	29
941 316	328075	04 01 01 04	450 g	1	pc(s)	30
941 400	133563	04 01 01 04	525 g	1	pc(s)	28
941 405	275331	04 01 01 04	428 g	1	pc(s)	29
941 406	328082	04 01 01 04	429 g	1	pc(s)	29
950 102	105621	04 01 02 13	184 g	1	pc(s)	99
950 112	105638	04 01 02 13	196 g	1	pc(s)	99
950 530	152960	04 01 02 09	300 g	1	pc(s)	90
950 531	152953	04 01 02 09	275 g	1	pc(s)	90
950 535	154988	04 01 02 09	310 g	1	pc(s)	90
950 536	154995	04 01 02 09	285 g	1	pc(s)	90
951 001	108066	04 01 01 01	192 g	1	pc(s)	25
951 050	108073	04 01 01 01	171 g	1	pc(s)	25
951 100	108080	04 01 01 01	171 g	1	pc(s)	25
951 110	108110	04 01 01 01	659 g	1	pc(s)	24
951 115	108127	04 01 01 01	664 g	1	pc(s)	24
951 200	108097	04 01 01 01	724 g	1	pc(s)	24
951 205	108103	04 01 01 01	668 g	1	pc(s)	24
951 300	108134	04 01 01 01	970 g	1	pc(s)	23
951 305	108141	04 01 01 01	962 g	1	pc(s)	23
951 310	108172	04 01 01 01	1.27 kg	1	pc(s)	23
951 315	108189	04 01 01 01	1.28 kg	1	pc(s)	23
951 400	108158	04 01 01 01	1.35 kg	1	pc(s)	23
951 405	108165	04 01 01 01	1.36 kg	1	pc(s)	23
952 010	108356	04 01 02 01	43 g	1	pc(s)	97
952 011	109773	04 01 02 01	32 g	1	pc(s)	97
952 012	109780	04 01 02 01	35 g	1	pc(s)	97
952 013	109797	04 01 02 01	46 g	1	pc(s)	97
952 014	108363	04 01 02 01	50 g	1	pc(s)	97
952 015	109803	04 01 02 01	53 g	1	pc(s)	97
952 016	109810	04 01 02 01	64 g	1	pc(s)	97
952 017	113329	04 01 02 01	63 g	1	pc(s)	97
952 018	119482	04 01 02 01	36 g	1	pc(s)	97
952 020	127784	04 01 02 03	52 g	1	pc(s)	97
952 022	376533	04 01 02 24	43 g	1	pc(s)	96
952 024	377356	04 01 02 24	52 g	1	pc(s)	96
952 025	127357	04 01 02 04	34 g	1	pc(s)	98
952 027	127364	04 01 02 04	40 g	1	pc(s)	98
952 028	387843	04 01 02 24	51 g	1	pc(s)	96
952 029	127371	04 01 02 04	44 g	1	pc(s)	98
952 030	108530	04 01 02 06	111 g	1	pc(s)	81
952 035	108547	04 01 02 06	114 g	1	pc(s)	81
952 041	141841	04 01 02 07	53 g	1	pc(s)	98
952 043	141834	04 01 02 07	42 g	1	pc(s)	98
952 044	141858	04 01 02 07	62 g	1	pc(s)	98
952 045	141827	04 01 02 07	33 g	1	pc(s)	98
952 048	327733	04 01 02 22	51 g	1	pc(s)	98
952 049	327740	04 01 02 22	60 g	1	pc(s)	98
952 050	108370	04 01 02 01	38 g	1	pc(s)	97
952 051	126442	04 01 02 07	49 g	1	pc(s)	98
952 053	127647	04 01 02 07	42 g	1	pc(s)	98

Part No.	GTIN*	PG	Weight	PU	SU	Page
952 054	127975	04 01 02 07	52 g	1	pc(s)	98
952 055	136700	04 01 02 07	36 g	1	pc(s)	98
952 056	149106	04 01 02 08	71 g	1	pc(s)	98
952 060	108387	04 01 02 06	37 g	1	pc(s)	97
952 070	108493	04 01 02 02	130 g	1	pc(s)	65
952 071	109834	04 01 02 02	107 g	1	pc(s)	65
952 072	109858	04 01 02 02	109 g	1	pc(s)	65
952 073	109872	04 01 02 02	119 g	1	pc(s)	65
952 074	108516	04 01 02 02	123 g	1	pc(s)	65
952 075	109896	04 01 02 02	142 g	1	pc(s)	65
952 076	109919	04 01 02 02	136 g	1	pc(s)	65
952 077	119680	04 01 02 02	137 g	1	pc(s)	66
952 078	119468	04 01 02 02	109 g	1	pc(s)	65
952 079	128446	04 01 02 03	141 g	1	pc(s)	57
952 080	127296	04 01 02 04	107 g	1	pc(s)	67
952 081	318182	04 01 02 01	38 g	1	pc(s)	97
952 082	127319	04 01 02 04	113 g	1	pc(s)	67
952 083	376540	04 01 02 24	51 g	1	pc(s)	97
952 084	127333	04 01 02 04	117 g	1	pc(s)	67
952 085	127302	04 01 02 04	111 g	1	pc(s)	67
952 087	127326	04 01 02 04	116 g	1	pc(s)	67
952 089	127340	04 01 02 04	121 g	1	pc(s)	67
952 090	108509	04 01 02 02	119 g	1	pc(s)	66
952 091	109841	04 01 02 02	110 g	1	pc(s)	66
952 092	109865	04 01 02 02	113 g	1	pc(s)	66
952 093	109889	04 01 02 02	137 g	1	pc(s)	66
952 094	108523	04 01 02 02	140 g	1	pc(s)	66
952 095	109902	04 01 02 02	140 g	1	pc(s)	66
952 096	109926	04 01 02 02	160 g	1	pc(s)	66
952 097	119697	04 01 02 02	140 g	1	pc(s)	66
952 098	119475	04 01 02 02	123 g	1	pc(s)	66
952 099	128453	04 01 02 03	129 g	1	pc(s)	57
952 100	376526	04 01 02 24	128 g	1	pc(s)	54
952 110	108417	04 01 02 01	242 g	1	pc(s)	62
952 111	119420	04 01 02 01	232 g	1	pc(s)	62
952 113	387874	04 01 02 24	128 g	1	pc(s)	54
952 115	108424	04 01 02 01	228 g	1	pc(s)	63
952 116	119413	04 01 02 01	236 g	1	pc(s)	63
952 121	376663	04 01 02 24	250 g	1	pc(s)	54
952 122	387867	04 01 02 24	250 g	1	pc(s)	54
952 130	128521	04 01 02 01	247 g	1	pc(s)	62
952 135	128538	04 01 02 01	253 g	1	pc(s)	63
952 171	128422	04 01 02 03	233 g	1	pc(s)	57
952 173	128408	04 01 02 03	257 g	1	pc(s)	56
952 176	128439	04 01 02 03	260 g	1	pc(s)	57
952 178	128415	04 01 02 03	264 g	1	pc(s)	56
952 181	318175	04 01 02 01	228 g	1	pc(s)	62
952 185	318151	04 01 02 01	228 g	1	pc(s)	62
952 200	108394	04 01 02 01	229 g	1	pc(s)	62
952 201	123915	04 01 02 01	211 g	1	pc(s)	62
952 205	108400	04 01 02 01	232 g	1	pc(s)	62
952 206	123922	04 01 02 01	217 g	1	pc(s)	62
952 220	376656	04 01 02 24	241 g	1	pc(s)	53
952 300	108431	04 01 02 01	334 g	1	pc(s)	60
952 302	113305	04 01 02 01	386 g	1	pc(s)	63
952 303	120709	04 01 02 01	355 g	1	pc(s)	60
952 304	128361	04 01 02 03	376 g	1	pc(s)	56
952 305	108448	04 01 02 01	328 g	1	pc(s)	61
952 307	113312	04 01 02 01	388 g	1	pc(s)	63
952 308	120716	04 01 02 01	362 g	1	pc(s)	61
952 309	128378	04 01 02 03	382 g	1	pc(s)	56

Part No.	GTIN*	PG	Weight	PU	SU	Page
952 310	108479	04 01 02 01	405 g	1	pc(s)	61
952 311	119390	04 01 02 01	432 g	1	pc(s)	61
952 313	123939	04 01 02 01	299 g	1	pc(s)	60
952 314	124028	04 01 02 01	342 g	1	pc(s)	60
952 315	108486	04 01 02 01	415 g	1	pc(s)	62
952 316	119406	04 01 02 01	436 g	1	pc(s)	62
952 318	124011	04 01 02 01	306 g	1	pc(s)	61
952 319	124035	04 01 02 01	350 g	1	pc(s)	61
952 320	126794	04 01 02 01	416 g	1	pc(s)	61
952 322	128385	04 01 02 03	456 g	1	pc(s)	56
952 323	133235	04 01 02 01	381 g	1	pc(s)	61
952 325	126800	04 01 02 01	425 g	1	pc(s)	62
952 327	128392	04 01 02 03	475 g	1	pc(s)	56
952 328	133242	04 01 02 01	390 g	1	pc(s)	62
952 330	376649	04 01 02 24	354 g	1	pc(s)	53
952 341	376632	04 01 02 24	452 g	1	pc(s)	53
952 342	387850	04 01 02 24	452 g	1	pc(s)	53
952 381	318144	04 01 02 01	405 g	1	pc(s)	61
952 385	318137	04 01 02 01	415 g	1	pc(s)	61
952 400	108455	04 01 02 01	414 g	1	pc(s)	61
952 401	128347	04 01 02 03	475 g	1	pc(s)	56
952 403	128569	04 01 02 01	417 g	1	pc(s)	61
952 404	128545	04 01 02 01	474 g	1	pc(s)	61
952 405	108462	04 01 02 01	453 g	1	pc(s)	61
952 406	128354	04 01 02 03	473 g	1	pc(s)	56
952 408	128576	04 01 02 01	426 g	1	pc(s)	61
952 409	128552	04 01 02 01	482 g	1	pc(s)	61
952 440	376625	04 01 02 24	449 g	1	pc(s)	53
952 510	126428	04 01 02 07	340 g	1	pc(s)	86
952 511	127494	04 01 02 07	291 g	1	pc(s)	86
952 512	127951	04 01 02 07	336 g	1	pc(s)	86
952 513	136663	04 01 02 07	269 g	1	pc(s)	86
952 514	224964	04 01 02 07	499 g	1	pc(s)	87
952 515	126435	04 01 02 07	323 g	1	pc(s)	86
952 516	127500	04 01 02 07	298 g	1	pc(s)	86
952 517	127968	04 01 02 07	338 g	1	pc(s)	86
952 518	136670	04 01 02 07	276 g	1	pc(s)	86
952 519	224971	04 01 02 07	509 g	1	pc(s)	87
952 520	149069	04 01 02 08	501 g	1	pc(s)	89
952 525	149076	04 01 02 08	521 g	1	pc(s)	89
952 550	136502	04 01 02 07	200 g	1	pc(s)	86
952 551	136687	04 01 02 07	182 g	1	pc(s)	86
952 555	136519	04 01 02 07	203 g	1	pc(s)	86
952 556	136694	04 01 02 07	187 g	1	pc(s)	86
952 561	149083	04 01 02 08	333 g	1	pc(s)	89
952 565	327719	04 01 02 22	300 g	1	pc(s)	84
952 566	149090	04 01 02 08	341 g	1	pc(s)	89
952 567	327726	04 01 02 22	329 g	1	pc(s)	84
952 589	132306	04 01 04 03	17 g	1	pc(s)	121
952 610	149816	04 01 02 12	18 g	1	pc(s)	94
952 614	149847	04 01 02 12	18 g	1	pc(s)	94
952 641	146334	04 01 02 12	18 g	1	pc(s)	94
952 643	150737	04 01 02 12	18 g	1	pc(s)	94
952 644	149892	04 01 02 12	18 g	1	pc(s)	94
952 650	149823	04 01 02 12	18 g	1	pc(s)	95
952 651	146310	04 01 02 12	18 g	1	pc(s)	93
952 653	150713	04 01 02 12	18 g	1	pc(s)	93
952 654	149878	04 01 02 12	18 g	1	pc(s)	93
952 699	127906	04 01 04 03	103 g	1	pc(s)	121
952 710	149830	04 01 02 12	18 g	1	pc(s)	94
952 714	149854	04 01 02 12	18 g	1	pc(s)	94

Part No.	GTIN*	PG	Weight	PU	SU	Page
952 741	146341	04 01 02 12	18 g	1	pc(s)	94
952 743	150744	04 01 02 12	18 g	1	pc(s)	94
952 744	149908	04 01 02 12	18 g	1	pc(s)	94
952 750	149861	04 01 02 12	18 g	1	pc(s)	95
952 751	146327	04 01 02 12	18 g	1	pc(s)	94
952 753	150720	04 01 02 12	18 g	1	pc(s)	94
952 754	149885	04 01 02 12	18 g	1	pc(s)	94
952 908	264526	04 01 02 14	112 g	1	pc(s)	69
952 908	264526	04 01 02 14	112 g	1	pc(s)	98
952 910	266865	04 01 02 12	18 g	1	pc(s)	95
952 918	308336	04 01 02 14	112 g	1	pc(s)	69
952 918	308336	04 01 02 14	112 g	1	pc(s)	98
952 920	322622	04 01 02 23	161 g	1	pc(s)	59
952 923	322639	04 01 02 23	167 g	1	pc(s)	59
952 926	322646	04 01 02 23	72 g	1	pc(s)	59
952 926	322646	04 01 02 23	72 g	1	pc(s)	97
952 927	322653	04 01 02 23	78 g	1	pc(s)	59
952 927	322653	04 01 02 23	78 g	1	pc(s)	97
952 938	264014	04 01 02 14	207 g	1	pc(s)	68
952 940	308329	04 01 02 14	207 g	1	pc(s)	69
952 941	228177	04 01 02 12	18 g	1	pc(s)	95
952 948	323919	04 01 02 12	18 g	1	pc(s)	95
952 949	323926	04 01 02 12	18 g	1	pc(s)	95
952 951	228184	04 01 02 12	18 g	1	pc(s)	95
953 010	108295	04 01 03 01	28 g	1	pc(s)	107
953 011	109636	04 01 03 01	27 g	1	pc(s)	107
953 012	109643	04 01 03 01	27 g	1	pc(s)	107
953 013	109650	04 01 03 01	25 g	1	pc(s)	107
953 014	109667	04 01 03 01	26 g	1	pc(s)	107
953 020	117440	04 01 03 01	59 g	1	pc(s)	107
953 021	353077	04 01 03 01	49 g	1	pc(s)	107
953 200	108301	04 01 03 01	81 g	1	pc(s)	104
953 201	109674	04 01 03 01	80 g	1	pc(s)	104
953 202	109681	04 01 03 01	81 g	1	pc(s)	104
953 203	109698	04 01 03 01	79 g	1	pc(s)	104
953 204	109704	04 01 03 01	79 g	1	pc(s)	104
953 205	108318	04 01 03 01	84 g	1	pc(s)	105
953 206	109711	04 01 03 01	84 g	1	pc(s)	105
953 207	109728	04 01 03 01	85 g	1	pc(s)	105
953 208	109735	04 01 03 01	83 g	1	pc(s)	105
953 209	109742	04 01 03 01	82 g	1	pc(s)	105
953 228	158986	04 01 03 01	79 g	1	pc(s)	105
953 229	158993	04 01 03 01	83 g	1	pc(s)	105
953 400	115767	04 01 03 01	147 g	1	pc(s)	106
953 405	115774	04 01 03 01	151 g	1	pc(s)	106
953 406	353060	04 01 03 01	151 g	1	pc(s)	106
961 001	118584	04 01 01 08	173 g	1	pc(s)	35
961 002	118591	04 01 01 08	195 g	1	pc(s)	35
961 003	118607	04 01 01 08	180 g	1	pc(s)	35
961 010	118744	04 01 01 14	170 g	1	pc(s)	49
961 010	118744	04 01 01 14	170 g	1	pc(s)	252
961 020	118706	04 01 01 14	139 g	1	pc(s)	49
961 022	118669	04 01 01 08	195 g	1	pc(s)	45
961 101	118676	04 01 01 14	315 g	1	pc(s)	48
961 102	118690	04 01 01 14	284 g	1	pc(s)	48
961 105	118683	04 01 01 14	320 g	1	pc(s)	48

Part No.	GTIN*	PG	Weight	PU	SU	Page
961 110	118560	04 01 01 08	317 g	1	pc(s)	34
961 115	118577	04 01 01 08	321 g	1	pc(s)	34
961 120	118614	04 01 01 08	340 g	1	pc(s)	34
961 122	118652	04 01 01 08	358 g	1	pc(s)	45
961 125	118621	04 01 01 08	343 g	1	pc(s)	34
961 130	118638	04 01 01 08	325 g	1	pc(s)	34
961 135	118645	04 01 01 08	330 g	1	pc(s)	34
961 140	116269	04 01 01 09	516 g	1	pc(s)	40
961 145	116276	04 01 01 09	520 g	1	pc(s)	40
961 146	250062	04 01 01 10	946 g	1	pc(s)	38
961 160	116290	04 01 01 14	369 g	1	pc(s)	48
961 165	116306	04 01 01 14	372 g	1	pc(s)	48
961 175	116283	04 01 01 09	507 g	1	pc(s)	40
961 176	250123	04 01 01 10	908 g	1	pc(s)	38
961 180	157323	04 01 01 14	370 g	1	pc(s)	48
961 185	157330	04 01 01 14	370 g	1	pc(s)	48
961 200	145108	04 01 01 03	432 g	1	pc(s)	26
961 205	145115	04 01 01 03	435 g	1	pc(s)	26
971 001	138605	04 01 01 12	139 g	1	pc(s)	44
971 002	133655	04 01 01 12	106 g	1	pc(s)	44
971 003	144491	04 01 01 12	108 g	1	pc(s)	44
971 010	138636	04 01 01 12	171 g	1	pc(s)	44
971 120	133631	04 01 01 12	252 g	1	pc(s)	43
971 121	138582	04 01 01 12	284 g	1	pc(s)	43
971 122	144477	04 01 01 12	258 g	1	pc(s)	43
971 125	133648	04 01 01 12	226 g	1	pc(s)	44
971 126	138599	04 01 01 12	288 g	1	pc(s)	44
971 127	144484	04 01 01 12	254 g	1	pc(s)	44
971 221	138612	04 01 01 12	608 g	1	pc(s)	44
971 226	138629	04 01 01 12	614 g	1	pc(s)	44
972 010	158672	04 01 02 15	48 g	1	pc(s)	83
972 010	158672	04 01 02 15	48 g	1	pc(s)	98
972 020	158702	04 01 02 15	57 g	1	pc(s)	83
972 020	158702	04 01 02 15	57 g	1	pc(s)	98
972 030	158719	04 01 02 15	71 g	1	pc(s)	83
972 030	158719	04 01 02 15	71 g	1	pc(s)	98
972 040	158764	04 01 02 15	77 g	1	pc(s)	83
972 040	158764	04 01 02 15	77 g	1	pc(s)	98
972 050	343825	04 01 02 15	89 g	1	pc(s)	83
972 051	347977	04 01 02 15	40 g	1	pc(s)	83
972 110	158504	04 01 02 15	138 g	1	pc(s)	83
972 115	158511	04 01 02 15	142 g	1	pc(s)	83
972 120	158528	04 01 02 15	148 g	1	pc(s)	83
972 125	158610	04 01 02 15	152 g	1	pc(s)	83
972 130	158627	04 01 02 15	162 g	1	pc(s)	83
972 135	158634	04 01 02 15	167 g	1	pc(s)	83
972 140	158641	04 01 02 15	168 g	1	pc(s)	83
972 145	158658	04 01 02 15	172 g	1	pc(s)	83
972 146	347960	04 01 02 15	497 g	1	pc(s)	82
989 408	120396	04 02 11 01	1.00 kg	1	pc(s)	175
999 799	328723	04 01 02 07	509 g	1	pc(s)	87
999 906	310926	04 01 02 05	54 g	1	pc(s)	78
999 937	303195	04 01 02 05	56 g	1	pc(s)	79
999 990	153776	04 01 06 01	5.07 kg	1	pc(s)	250

Type	Page No.	Page	Type	Page No.	Page	Type	Page No.	Page	Type	Page No.	Page
AB EXFS IF1 W 11	923 311	249	BCO MOD ML2 BE HF 5	927 070	159	BXT ML2 BE S 5	920 220	166	DCO SD2 MD 12	917 940	186
AB EXFS IF1 W 14	923 314	249	BM 10 DRL	907 499	199	BXT ML2 MY 250	920 289	167	DCO SD2 MD 24	917 941	186
AB EXFS IF1 W 18	923 318	249	BS BA1 BA15 BXT	920 398	176	BXT ML2 MY E 110	920 288	167	DCO SD2 MD 48	917 942	186
AB EXFS IF1 W 22	923 322	249	BS BA1 BA15 BXT	920 398	238	BXT ML4 B 180	920 310	162	DCO SD2 MD EX 24	917 960	187
AB EXFS IF1 W 26	923 326	249	BSP BAS 4	926 304	161	BXT ML4 BC 24	920 354	164	DCO SD2 MD HF 5	917 970	186
AB EXFS IF1 W 30	923 330	249	BSP M2 BD 12	926 242	172	BXT ML4 BC 5	920 350	164	DCO SD2 ME 12	917 920	186
AB EXFS IF1 W 33	923 333	249	BSP M2 BD 180	926 247	172	BXT ML4 BC EX 24	920 384	174	DCO SD2 ME 24	917 921	186
AB EXFS IF1 W 36	923 336	249	BSP M2 BD 24	926 244	172	BXT ML4 BD 12	920 342	163	DCO SD2 ME 48	917 922	186
AB EXFS IF1 W 39	923 339	249	BSP M2 BD 48	926 245	172	BXT ML4 BD 180	920 347	163	DCOR 3P TT 275 FM	900 439	78
AB EXFS IF1 W 42	923 342	249	BSP M2 BD 5	926 240	172	BXT ML4 BD 24	920 344	163	DCOR L 1P 275	900 431	78
AB EXFS IF1 W 48	923 348	249	BSP M2 BD 60	926 246	172	BXT ML4 BD 48	920 345	163	DCOR L 1P 320	900 433	78
AB EXFS IF1 W 56	923 356	249	BSP M2 BD HF 24	926 275	172	BXT ML4 BD 5	920 340	163	DCOR L 2P 275	900 430	78
AB EXFS IF1 W 62	923 362	249	BSP M2 BD HF 5	926 271	172	BXT ML4 BD 60	920 346	163	DCOR L 2P 275 SO IP	900 448	80
AB EXFS IF3 G 11	923 211	249	BSP M2 BE 12	926 222	171	BXT ML4 BD EX 24	920 381	174	DCOR L 2P 275 SO LT	900 435	80
AB EXFS IF3 G 14	923 214	249	BSP M2 BE 180	926 227	171	BXT ML4 BD HF 24	920 375	164	DCOR L 2P 275 SO LTG	900 446	79
AB EXFS IF3 G 18	923 218	249	BSP M2 BE 24	926 224	171	BXT ML4 BD HF 5	920 371	164	DCOR L 2P 320	900 432	78
AB EXFS IF3 G 22	923 222	249	BSP M2 BE 48	926 225	171	BXT ML4 BE 12	920 322	163	DCOR L 2P SN1860	999 937	79
AB EXFS IF3 G 26	923 226	249	BSP M2 BE 5	926 220	171	BXT ML4 BE 180	920 327	163	DCOR L 2P SN1864	999 906	78
AB EXFS IF3 G 30	923 230	249	BSP M2 BE HF 5	926 270	172	BXT ML4 BE 24	920 324	163	DCOR L 3P 275 SO IP	900 447	80
AB EXFS IF3 G 33	923 233	249	BSP M4 BD 12	926 342	171	BXT ML4 BE 36	920 336	163	DCOR L 3P 275 SO LTG	900 445	79
AB EXFS IF3 G 36	923 236	249	BSP M4 BD 180	926 347	171	BXT ML4 BE 48	920 325	163	DCOR R 3P 275	900 449	80
AB EXFS IF3 G 39	923 239	249	BSP M4 BD 24	926 344	171	BXT ML4 BE 5	920 320	163	DCU YPV SCI 1000 1M	900 910	91
AB EXFS IF3 G 42	923 242	249	BSP M4 BD 48	926 345	171	BXT ML4 BE 60	920 326	163	DCU YPV SCI 1000 2M	900 920	91
AK 16 AS SAK MS	308 411	231	BSP M4 BD 5	926 340	171	BXT ML4 BE BD 24	920 334	165	DDT BDU	915 051	118
AK 35 SN 18X3 GG	919 015	232	BSP M4 BD HF 24	926 375	172	BXT ML4 BE C 12	920 362	164	DDT DL	915 000	117
AL DCU Y PV L3X1000	900 945	92	BSP M4 BD HF 5	926 371	172	BXT ML4 BE C 24	920 364	164	DDT DL TCP	915 001	117
AL EXFS L100 KS	923 025	249	BSP M4 BE 12	926 322	170	BXT ML4 BE HF 5	920 370	164	DFL A 255	924 389	113
AL EXFS L200 KS	923 035	249	BSP M4 BE 180	926 327	170	BXT ML4 BPD 24	920 314	163	DFL D 255	924 395	113
AL2 10DA LSA	907 997	202	BSP M4 BE 24	926 324	170	BXT ML4 MY 110	920 388	165	DFL M 255	924 396	113
ALGA 5	906 055	234	BSP M4 BE 48	926 325	170	BXT ML4 MY 250	920 389	165	DG 1000	950 102	99
ALGA 5 X	906 058	234	BSP M4 BE 5	926 320	170	BXTU ML2 BD S 0-180	920 249	169	DG 1000 FM	950 112	99
AR1 STW	924 328	110	BSP M4 BE HF 5	926 370	171	BXTU ML4 BD 0-180	920 349	169	DG M H TT 275	952 381	61
AR1 TW	924 336	111	BT 24	925 001	218	DB 1 255 H	900 222	46	DG M H TT 275 FM	952 385	61
AS SAK 1000 V2A	308 421	231	BVT ALD 36	918 408	192	DB 3 255 H	900 120	46	DG M H TT 2P 275	952 181	62
AW2 LSA	907 994	202	BVT ALD 60	918 409	192	DB M 1 150	961 110	34	DG M H TT 2P 275 FM	952 185	62
BCO CL2 B 180	927 910	183	BVT AVD 24	918 422	192	DB M 1 150 FM	961 115	34	DG MPV2 SCI 1000	952 514	87
BCO CL2 BD 12	927 942	183	BVT KKS ALD 75	918 420	193	DB M 1 255	961 120	34	DG MPV2 SCI 1000 FM	952 519	87
BCO CL2 BD 24	927 944	183	BVT KKS APD 36	918 421	193	DB M 1 255 FM	961 125	34	DG MPV2 SCISN1868 FM	999 799	87
BCO CL2 BD 48	927 945	183	BVT RS485 5	918 401	192	DB M 1 320	961 130	34	DG M TN 150	952 201	62
BCO CL2 BD EX 24	927 984	184	BVT TC 1	918 411	192	DB M 1 320 FM	961 135	34	DG M TN 150 FM	952 206	62
BCO CL2 BD HF 5	927 971	183	BW90 B11			DB M MOD 150	961 001	35	DG M TN 275	952 200	62
BCO CL2 BE 12	927 922	183	B5.1 6.5 11 V2A	106 310	225	DB M MOD 255	961 002	35	DG M TN 275 FM	952 205	62
BCO CL2 BE 24	927 924	183	BW90 B16			DB M MOD 320	961 003	35	DG M TN ACI 275 FM	952 220	53
BCO CL2 BE 48	927 925	183	B5.1 6.5 11 V2A	106 314	225	DB MU3PY2083W+GR	908 505	35	DG M TN CI 275	952 173	56
BCO CL2 BE HF 5	927 970	183	BW90 B17 21 16 V2A	106 329	225	DB MU3PY4803W+GR	908 506	35	DG M TN CI 275 FM	952 178	56
BCO ML2 B 180	927 210	157	BXT BAS	920 300	161	DBH M 1 255	961 122	45	DG M TNC 150	952 313	60
BCO ML2 BD 12	927 242	157	BXT BAS EX	920 301	173	DBH MOD 255	961 022	45	DG M TNC 150 FM	952 318	61
BCO ML2 BD 24	927 244	157	BXT M2 BD HC5A 24	920 296	167	DBM 1 255 S	900 220	41	DG M TNC 275	952 300	60
BCO ML2 BD 48	927 245	157	BXT M2 BD S EX 24	920 383	175	DBM 1 440	961 140	40	DG M TNC 275 FM	952 305	61
BCO ML2 BD EX 24	927 284	158	BXT M4 E	920 308	176	DBM 1 440 FM	961 145	40	DG M TNC 385	952 314	60
BCO ML2 BD HF 5	927 271	158	BXT M4 T	920 309	176	DBM 1 760 FM	961 175	40	DG M TNC 385 FM	952 319	61
BCO ML2 BE 12	927 222	157	BXT ML2 B 180	920 211	166	DBM 1 760 FM	961 175	40	DG M TNC 440	952 303	60
BCO ML2 BE 24	927 224	157	BXT ML2 BD 180	920 247	165	DBM 1 CI 440 FM	961 146	38	DG M TNC 440 FM	952 308	61
BCO ML2 BE 48	927 225	157	BXT ML2 BD DL S 15	920 243	167	DBM 1 CI 760 FM	961 176	38	DG M TNC ACI 275 FM	952 330	53
BCO ML2 BE HF 5	927 270	157	BXT ML2 BD HF EX 6	920 538	174	DBM NH00 255	900 255	36	DG M TNC CI 275	952 304	56
BCO MOD ML2 B 180	927 010	158	BXT ML2 BD HFS 5	920 271	166	DBX TC 180	922 210	220	DG M TNC CI 275 FM	952 309	56
BCO MOD ML2 BD 12	927 042	159	BXT ML2 BD S 12	920 242	165	DBX TC B 180	922 220	220	DG M TNS 150	952 403	61
BCO MOD ML2 BD 24	927 044	159	BXT ML2 BD S 24	920 244	165	DBX U4 KT BD S 0-180	922 400	220	DG M TNS 150 FM	952 408	61
BCO MOD ML2 BD 48	927 045	159	BXT ML2 BD S 48	920 245	165	DCB YPV 1200	900 070	32	DG M TNS 275	952 400	61
BCO MOD ML2 BD EX 24	927 084	159	BXT ML2 BD S 5	920 240	165	DCB YPV 1200 FM	900 075	32	DG M TNS 275 FM	952 405	61
BCO MOD ML2 BD HF 5	927 071	159	BXT ML2 BD S EX 24	920 280	174	DCB YPV 1500	900 071	32	DG M TNS 385	952 404	61
BCO MOD ML2 BE 12	927 022	158	BXT ML2 BE HFS 5	920 270	166	DCB YPV 1500 FM	900 076	32	DG M TNS 385 FM	952 409	61
BCO MOD ML2 BE 24	927 024	158	BXT ML2 BE S 12	920 222	166	DCO SD2	917 900	188	DG M TNS ACI 275 FM	952 440	53
BCO MOD ML2 BE 48	927 025	158	BXT ML2 BE S 24	920 224	166	DCO SD2 E 12	917 987	186	DG M TNS CI 275	952 401	56
			BXT ML2 BE S 36	920 226	166	DCO SD2 E 24	917 988	186	DG M TNS CI 275 FM	952 406	56
			BXT ML2 BE S 48	920 225	166	DCO SD2 E 48	917 989	186	DG M TT 150	952 323	61

Type	Page No.	Page	Type	Page No.	Page	Type	Page No.	Page	Type	Page No.	Page
DG M TT 150 FM	952 328	62	DG MOD NPE	952 050	97	DG PLU 510	908 013	74	DGA FF TV	909 703	223
DG M TT 275	952 310	61	DG MOD PV 300	952 043	98	DG PLU 550	908 015	74	DGA FF5 TV	909 706	223
DG M TT 275 FM	952 315	62	DG MOD PV 500	952 041	98	DG S 150	952 072	65	DGA G BNC	929 042	224
DG M TT 2P 275	952 110	62	DG MOD PV 600	952 044	98	DG S 150 FM	952 092	66	DGA G N	929 044	224
DG M TT 2P 275 FM	952 115	63	DG MOD PV 75	952 045	98	DG S 275	952 070	65	DGA G SMA	929 039	224
DG M TT 2P 320	952 130	62	DG MOD PV SCI 300	952 053	98	DG S 275 FM	952 090	66	DGA GF TV	909 704	223
DG M TT 2P 320 FM	952 135	63	DG MOD PV SCI 500	952 051	98	DG S 275 VA	952 082	67	DGA GFF TV	909 705	223
DG M TT 2P 385	952 111	62	DG MOD PV SCI 600	952 054	98	DG S 275 VA FM	952 087	67	DGA L4 7 16 MFA	929 148	224
DG M TT 2P 385 FM	952 116	63	DG MOD PV SCI 75	952 055	98	DG S 320	952 073	65	DGA L4 7 16 S	929 047	224
DG M TT 2P ACI 275 FM	952 121	54	DG MU3PD2403W+G	908 351	71	DG S 320 FM	952 093	66	DGA LG 7 16 MFA	929 146	224
DG M TT 2P ACI 385 FM	952 122	54	DG MU3PD2403W+GR	908 356	71	DG S 385	952 074	65	DGP C MOD	952 060	97
DG M TT 2P CI 275	952 171	57	DG MU3PD4803W+G	908 350	71	DG S 385 FM	952 094	66	DGP C S	952 030	81
DG M TT 2P CI 275 FM	952 176	57	DG MU3PD4803W+GR	908 355	71	DG S 385 VA	952 084	67	DGP C S FM	952 035	81
DG M TT 320	952 320	61	DG MU3PH2404W+G	908 343	72	DG S 385 VA FM	952 089	67	DGP M 255	961 101	48
DG M TT 320 FM	952 325	62	DG MU3PH2404W+GR	908 348	72	DG S 440	952 075	65	DGP M 255 FM	961 105	48
DG M TT 385	952 311	61	DG MU3PH4804W+G	908 344	72	DG S 440 FM	952 095	66	DGP M MOD 255	961 010	49
DG M TT 385 FM	952 316	62	DG MU3PH4804W+GR	908 349	72	DG S 48	952 078	65	SDGP MOD DC Y 500	972 051	83
DG M TT ACI 275 FM	952 341	53	DG MU3PY2083W+G	908 300	70	DG S 48 FM	952 098	66	DGPH M 255	961 102	48
DG M TT ACI 385 FM	952 342	53	DG MU3PY2083W+GR	908 305	71	DG S 600	952 076	65	DGPH MOD 255	961 020	49
DG M TT CI 275	952 322	56	DG MU3PY2084W+G	908 340	71	DG S 600 FM	952 096	66	DGPM 1 255	961 180	48
DG M TT CI 275 FM	952 327	56	DG MU3PY208 4W+GR	908 345	72	DG S 75	952 071	65	DGPM 1 255 FM	961 185	48
DG M WE 600	952 302	63	DG MU 3PY 480 3W+G	908 314	70	DG S 75 FM	952 091	66	DGPM 1 255 S	900 050	48
DG M WE 600 FM	952 307	63	DG MU3PY4803W+GR	908 319	71	DG S 75 VA	952 080	67	DGPM 440	961 160	48
DG M YPV 1200 FM	952 565	84	DG MU3PY4804W+G	908 341	71	DG S 75 VA FM	952 085	67	DGPM 440 FM	961 165	48
DG M YPV 1500 FM	952 567	84	DG MU3PY4804W+GR	908 346	72	DG S ACI 275 FM	952 100	54	DK 25	952 699	121
DG M YPV SCI 1000	952 510	86	DG MU3PY6003W+G	908 301	70	DG S ACI 385 FM	952 113	54	DPA CLE IP66	929 221	211
DG M YPV SCI 1000 FM	952 515	86	DG MU3PY6003W+GR	908 306	71	DG S CI 275	952 079	57	DPA M CAT6 RJ45S 48	929 100	212
DG M YPV SCI 1200	952 512	86	DG MU3PY6004W+G	908 342	71	DG S CI 275 FM	952 099	57	DPA M CLD RJ45B 48	929 126	212
DG M YPV SCI 1200 FM	952 517	86	DG MU3PY6004W+GR	908 347	72	DG S PV SCI 150	952 551	86	DPA M CLE RJ45B 48	929 121	212
DG M YPV SCI 150	952 513	86	DG MUCGD2403W+G	908 203	73	DG S PV SCI 150 FM	952 556	86	DPAN L	910 200	120
DG M YPV SCI 150 FM	952 518	86	DG MUCGD2403W+GR	908 208	74	DG S PV SCI 600	952 550	86	DPG LSA 120 P	906 102	201
DG M YPV SCI 600	952 511	86	DG MUCGD4803W+G	908 204	73	DG S PV SCI 600 FM	952 555	86	DPG LSA 220 P	906 103	201
DG M YPV SCI 600 FM	952 516	86	DG MUCGD4803W+GR	908 209	74	DG S WE 600	952 077	66	DPG LSA 30 P	906 100	201
DG ME DC Y 950 FM	972 146	82	DG M USP2403W+G	908 190	72	DG S WE 600 FM	952 097	66	DPG LSA 60 P	906 101	201
DG ME YPV SCI 1500	952 520	89	DG M USP2403W+GR	908 195	73	DG SE CI 440 FM	952 920	59	DPI CD EXD 230 24 M	929 969	208
DG ME YPV SCI1500 FM	952 525	89	DG M USP4803W+G	908 192	72	DG SE CI WE 440 FM	952 923	59	DPI CD EXD 230 24 N	929 970	208
DG MOD 150	952 012	97	DG M USP4803W+GR	908 197	73	DG SE DC 242	972 120	83	DPI CD EXD 24 M	929 962	207
DG MOD 275	952 010	97	DG MUSPN2403W+G	908 214	73	DG SE DC 242 FM	972 125	83	DPI CD EXD 24 N	929 964	207
DG MOD 275 VA	952 027	98	DG MUSPN2403W+GR	908 219	73	DG SE DC 550	972 130	83	DPI CD EXI 24 M	929 961	207
DG MOD 320	952 013	97	DG PCB 275	952 610	94	DG SE DC 550 FM	972 135	83	DPI CD EXI 24 N	929 963	207
DG MOD 385	952 014	97	DG PCB 275 FM	952 710	94	DG SE DC 60	972 110	83	DPI CD EXI+D 2X24 M	929 950	208
DG MOD 385 VA	952 029	98	DG PCB 385	952 614	94	DG SE DC 60 FM	972 115	83	DPI CD EXI+D 2X24 N	929 951	208
DG MOD 440	952 015	97	DG PCB 385 FM	952 714	94	DG SE DC 900	972 140	83	DPI CD HF EXD 5 M	929 971	207
DG MOD 48	952 018	97	DG PCB I 275 FM	952 910	95	DG SE DC 900 FM	972 145	83	DPI MD 24 M 2S	929 941	206
DG MOD 600	952 016	97	DG PCB NPE	952 650	95	DG SE H 1000 FM	952 938	68	DPI MD EX 24 M 2	929 960	207
DG MOD 75	952 011	97	DG PCB NPE FM	952 750	95	DG SE H 1000 VA FM	952 940	69	DPI MD EX 24 N 2	929 965	207
DG MOD 75 VA	952 025	98	DG PCB PV 300	952 643	94	DG SE PV SCI 1500	952 561	89	DPI ME 24 N A2G	929 921	206
DG MOD 750	952 017	97	DG PCB PV 300 FM	952 743	94	DG SE PV SCI 1500 FM	952 566	89	DPL 10 G3 110	907 214	200
DG MOD A NPE	952 022	96	DG PCB PV 500	952 641	94	DG SU 1P 120	908 070	74	DPL 10 G3 110 FSD	907 216	200
DG MOD ACI 275	952 024	96	DG PCB PV 500 FM	952 741	94	DG SU 1P 120 R	908 090	74	DPRO 230	909 230	115
DG MOD ACI 385	952 028	96	DG PCB PV 600	952 644	94	DG SU 1P 240	908 074	74	DPRO 230 F	909 240	115
DG MOD CI 275	952 020	97	DG PCB PV 600 FM	952 744	94	DG SU 1P 240 R	908 094	74	DPRO 230 ISDN	909 320	217
DG MOD DC Y 500	972 050	83	DG PCB PV I 500 FM	952 941	95	DG SU 1P 347	908 076	74	DPRO 230 LAN100	909 321	217
DG MOD E CI 440	952 926	97	DG PCB PV I 600 FM	952 948	95	DG SU 1P 347 R	908 096	74	DPRO 230 NT	909 310	217
DG MOD E CI WE 440	952 927	97	DG PCB PV I 750 FM	952 949	95	DG TT 2P 5 275	900 450	64	DPRO 230 TV	909 300	216
DG MOD E DC 242	972 020	98	DG PCB PV SCI 300	952 653	93	DG TT 2P 5 275 NL	900 458	64	DR M 2P 150	953 204	104
DG MOD E DC 550	972 030	98	DG PCB PV SCI 300 FM	952 753	94	DG TT 5 275	900 455	64	DR M 2P 150 FM	953 209	105
DG MOD E DC 60	972 010	98	DG PCB PV SCI 500	952 651	93	DG TT 5 275 NL	900 459	64	DR M 2P 255	953 200	104
DG MOD E DC 900	972 040	98	DG PCB PV SCI 500 FM	952 751	94	DG YPV SCI 1000	950 530	90	DR M 2P 255 FM	953 205	105
DG MOD E H 1000	952 908	98	DG PCB PV SCI 600	952 654	93	DG YPV SCI 1000 FM	950 535	90	DR M2P 255 SN1802	953 228	105
DG MOD E H 1000 VA	952 918	98	DG PCB PV SCI 600 FM	952 754	94	DG YPV SCI 600	950 531	90	DR M2P255SN1803FM	953 229	105
DG MOD E PV SCI 750	952 056	98	DG PCB PVSCI I 500FM	952 951	95	DG YPV SCI 600 FM	950 536	90	DR M 2P 30	953 201	104
DG MOD H A NPE	952 083	97	DG PLU 180	908 011	74	DGA AG BNC	929 043	224	DR M 2P 30 FM	953 206	105
DG MOD H NPE	952 081	97	DG PLU 230	908 012	74	DGA AG N	929 045	224	DR M 2P 60	953 202	104
DG MOD H PV 600	952 048	98	DG PLU 275	908 010	74	DGA BNC VCD	909 710	222	DR M 2P 60 FM	953 207	105
DG MOD H PV 750	952 049	98	DG PLU 385	908 014	74	DGA BNC VCID	909 711	222	DR M 2P 75	953 203	104

Type	Page No.	Page	Type	Page No.	Page	Type	Page No.	Page	Type	Page No.	Page
DR M 2P 75 FM	953 208	105	DSI E 3	910 631	42	IGA 7 IP54	902 314	122	SAK 11 SN MS	919 011	232
DR M 4P 255	953 400	106	DSO 1 255	900 230	33	IPC P3	910 512	118	SAK 14 AS V4A	308 404	231
DR M 4P 255 FM	953 405	106	DV M TN 255	951 200	24	ITAK EXI BXT 24	989 408	175	SAK 18 AS V4A	308 405	231
DR M4P255SN1872 FM	953 406	106	DV M TN 255 FM	951 205	24	KB 10 DCO RK	919 880	188	SAK 21 AS V4A	308 406	231
DR MOD 150	953 014	107	DV M TNC 255	951 300	23	KFSU	923 021	246	SAK 26 AS V4A	308 407	231
DR MOD 255	953 010	107	DV M TNC 255 FM	951 305	23	KV M20 MS 10.5	929 984	208	SAK 33 AS V4A	308 408	231
DR MOD 30	953 011	107	DV M TNS 255	951 400	23	KV S M20 MS 9.5	929 982	208	SAK 6.5 SN MS	919 010	232
DR MOD 4P 255	953 020	107	DV M TNS 255 FM	951 405	23	LCS DRC BXT	910 652	177	SAK BXT LR	920 395	176
DR MOD4P255SN1871	953 021	107	DV M TT 255	951 310	23	LCS DRC BXT	910 652	241	SDS 1	923 110	255
DR MOD 60	953 012	107	DV M TT 255 FM	951 315	23	LH 6.8 SB50.150 SPSM8 V2A	200 039	213	SDS 2	923 117	255
DR MOD 75	953 013	107	DV M TT 2P 255	951 110	24	LS 1 50 H DCO	917 977	188	SDS 3	923 116	256
DRC AL MODBUS	910 694	239	DV M TT 2P 255 FM	951 115	24	LWL DSI 18M	910 642	42	SDS 4	923 118	256
DRC IRCM	910 710	236	DV MOD 255	951 001	25	LWL ST DSI	910 641	42	SDS 5	923 119	256
DRC LC M1+	910 655	241	DV MOD NPE 100	951 100	25	MA SDS M12	723 199	256	SFL PRO 6X	909 250	116
DRC LC M3+	910 653	241	DV MOD NPE 50	951 050	25	MB2 10 LSA	907 995	202	SFL PRO 6X 19"	909 251	116
DRC MCM AL XT	910 698	239	DVCI 1 255	961 200	26	MF DR 3RU 19"	929 335	213	SH 18X3 K	919 014	232
DRC MCM XT	910 695	238	DVCI 1 255 FM	961 205	26	MS DPA	929 199	213	SH1 18X3 ST	919 012	232
DRC SCM XT	910 696	238	DVR 2 BY S 150 FM	928 430	190	MS EB DPA DGA	929 200	213	SH2 18X3 ST	919 013	232
DRL 10 B 180	907 400	197	DVR BNC RS485 230	928 440	190	MS EB DPA DGA	929 200	225	SK EK480 G2S-2d LM DCOR	900 443	79
DRL 10 B 180 FSD	907 401	197	EB 1 2 1.5	900 460	126	MVS 1 2	900 617	124	SKB 19 9M SW	919 030	201
DRL HD 24	907 470	198	EB 1 2 5	900 419	126	MVS 1 3	900 615	124	SLK 16	910 099	234
DRL PD 180	907 430	198	EB 1 3 1.5	900 418	126	MVS 1 4	900 610	124	SN 18X3 CU 1000	919 016	232
DRL RD 110	907 445	198	EB 1 3 10	900 461	127	MVS 1 57	900 612	125	SPB 25X0.3 L100M V2A	540 901	254
DRL RD 12	907 441	198	EB 1 4 1.5	900 429	126	MVS 1 6	900 815	124	SPD+POP 2 255 C25	900 780	76
DRL RD 24	907 442	198	EB 1 4 13	900 462	127	MVS 1 7	900 848	124	SPD+POP 2 255 C32	900 781	76
DRL RD 48	907 443	198	EB 1 4 9	900 417	126	MVS 1 8	900 611	125	SPD+POP 2 255 C40	900 782	76
DRL RD 60	907 444	198	EB 4 F	929 095	225	MVS 3 6 6	900 595	125	SPD+POP 4 255 C25	900 785	76
DRL RE 12	907 421	197	EB DG 1000 1 3	900 411	126	MVS 3 6 8	900 813	125	SPD+POP 4 255 C32	900 786	76
DRL RE 180	907 425	197	EF 10 DRL	907 498	199	MVS 3 6 9	900 839	125	SPD+POP 4 255 C40	900 787	76
DRL RE 24	907 422	197	EL 16 B17	929 096	225	MVS 4 56	900 614	125	SPD+POP 4 255 C63	900 788	76
DRL RE 48	907 423	197	EL16 L1.05M 1KSO 8.10 1KSG 8	416 411	225	MVS 4 8 11	900 814	125	SPS PRO	912 253	109
DRL RE 60	907 424	197	EL2 38EA LSA	907 993	203	NAK SN4631	999 990	250	SR DRL	907 497	199
DSA 230 LA	924 370	110	EM 2 DRL	907 496	199	NF 10	912 254	108	ST AS SAK K	308 425	231
DSE M 1 220	971 120	43	ER DPI M20	929 996	208	NSM PRO TW	924 335	111	STAK 25	952 589	121
DSE M 1 220 FM	971 125	44	EX BRS 27	540 821	254	PA BXT	910 508	242	STAK 2X16	900 589	121
DSE M 1 242	971 122	43	EX BRS 300	540 803	254	PARTITION EXI	910 797	160	STAK 3X16	900 588	121
DSE M 1 242 FM	971 127	44	EX BRS 500	540 805	254	PAS I 6AP M10 V2A	472 209	225	STC 230	924 350	112
DSE M 1 60	971 121	43	EX BRS 90	540 801	254	PLOV IGA 12 24	902 317	123	TFS	923 023	246
DSE M 1 60 FM	971 126	44	EXFS 100	923 100	248	PM 20	910 511	242	TL2 10DA CC	907 991	203
DSE M 2P 60	971 221	44	EXFS 100 KU	923 101	249	POP 2 255 C25	900 760	76	TL2 10DA LSA	907 996	203
DSE M 2P 60 FM	971 226	44	EXFS KU	923 019	247	POP 2 255 C32	900 761	76	TW DRC MCM EX	910 697	175
DSE MOD 220	971 002	44	EXFS L100	923 060	247	POP 2 255 C40	900 762	76	TW DRC MCM EX	910 697	238
DSE MOD 242	971 003	44	EXFS L200	923 061	247	POP 4 255 C25	900 765	76	UGKF BNC	929 010	222
DSE MOD 60	971 001	44	EXFS L300	923 062	247	POP 4 255 C32	900 766	76	USB NANO 485	910 486	177
DSE MOD PE 60	971 010	44	FS 9E PB 6	924 017	227	POP 4 255 C40	900 767	76	USB NANO 485	910 486	238
DSH B TN 255 FM	941 206	30	GDT 230 B3	907 218	199	POP 4 255 C63	900 768	76	V NH00 280	900 261	101
DSH B TNC 255 FM	941 306	28	GDT 230 B3 FSD	907 219	199	PSU DC24 30W	910 499	177	V NH00 280 FM	900 263	101
DSH B TNS 255 FM	941 406	29	GDT 230 G3	907 208	200	SA KRF 10 V2A	919 031	233	V NH1 280	900 270	101
DSH B TT 255 FM	941 316	30	GDT 230 G3 FSD	907 217	200	SA KRF 15 V2A	919 032	233	VA NH00 280	900 262	101
DSH B TT 2P 255 FM	941 116	31	GDT DGA 230	929 498	225	SA KRF 22 V2A	919 033	233	VA NH00 280 FM	900 264	101
DSH TN 255	941 200	30	GDT DGA 470	929 499	225	SA KRF 29 V2A	919 034	233	VA NH1 280	900 271	101
DSH TN 255 FM	941 205	30	GDT DGA 90	929 497	225	SA KRF 37 V2A	919 035	233	VC 280 2	900 471	114
DSH TNC 255	941 300	28	IGA 10 V2 IP54	902 315	122	SA KRF 50 V2A	919 036	233	VCSD 40 IP65	923 401	252
DSH TNC 255 FM	941 305	28	IGA 12 IP54	902 471	123	SA KRF 70 V2A	919 037	233	ZAP STW	924 329	110
DSH TNS 255	941 400	28	IGA 12 IP65	902 316	123	SA KRF 94 V2A	919 038	233			
DSH TNS 255 FM	941 405	29	IGA 24 IP54	902 472	123	SAK 10 AS V4A	308 403	231			
DSH TT 255	941 310	29	IGA 6 IP54	902 485	122						
DSH TT 255 FM	941 315	29									
DSH TT 2P 255	941 110	31									
DSH TT 2P 255 FM	941 115	31									

All the information in this catalogue on the possible applications of our products is exclusively intended as product-related information and advice based on our experience and provided to the best of our knowledge and, as such, should be understood as non-binding information. This applies, in particular, with regard to different operating conditions which are beyond our control. We recommend checking whether the DEHN product is suitable for the intended application. Application, use and processing of the products is beyond our control and is therefore the sole responsibility of the user.

Illustrations are not binding.

We accept no liability for misprints, modifications and errors.

***) GTIN (EAN code)**

In the catalogue, you will find the GTIN (EAN code) next to the Part No. For reasons of clarity, only the individual GTIN part is specified.

The country and DEHN code (40 13364) must be put in front of this number.

¹⁾The country and DEHN code (69 42299) must be put in front of this number.

Abbreviations:

PG Product Group

PU Packing Unit

SU Sales Unit (piece, meter, set or pair)

Pc(s) Piece(s)

m Meter

Pa Pair

Weight Weight per sales unit

Key Words

Product	Page	Product	Page	Product	Page
Accessories for BLITZDUCTOR XT Ex (i)	175	DEHNguard 1000	99	Isolating Spark Gaps	246
Accessories for BLITZDUCTOR XT/XTU	177	DEHNguard ME/SE DC ... (FM)	82	ITAK Ex (i)	175
Accessories for BLITZDUCTOR XT/XTU/SP/XT Ex (i)	176	DEHNguard modular	60	Mains Filter	108
Accessories for DEHNconnect SD2	188	DEHNguard modular E (Y)PV SCI 1500	88	NSM Protector	111
Accessories for DEHNpipe	208	DEHNguard modular for North America	70	Pipe Clamps for Ex Zones 1/21, 2/22	253
Accessories for DEHNrapid LSA	199	DEHNguard modular with Advanced Circuit Interruption (Safe Dimensioning)	52	Protection Module for DEHNbloc modular	35
Accessories for LSA Technology	202;	DEHNguard modular with Integrated Backup Fuse	55	Protection Module for DEHNgap modular	49
BLITZDUCTOR – Base Parts	161	DEHNguard modular YPV ... FM	84	Protection Module for DEHNguard ...	96
BLITZDUCTORconnect – Compact	182	DEHNguard modular (Y)PV SCI ...	85	Protection Module for DEHNguard M UL series	74
BLITZDUCTORconnect – Modular	156	DEHNguard PCB	93	Protection Module for DEHNrail modular	107
BLITZDUCTOR SP	170	DEHNguard S	65	Protection Module for DEHNsecure modular	44
BLITZDUCTOR VT	191	DEHNguard SE CI with Integrated Backup Fuse	58	Protection Module for DEHNventil modular	25
BLITZDUCTOR XT	162	DEHNguard SE H ... FM	68	Protection Solutions and Product Recommendations for Buildings	14
BLITZDUCTOR XT Ex (i)	173	DEHNguard S ... VA	67	RFID LifeCheck SPD Test Devices	240
BLITZDUCTOR XTU	168	DEHNguard YPV SCI ... – Compact	90	Selection Chart – Functional Buildings	21/51
Busbars/Modular Wiring System	124	DEHNpanel	120	Selection Chart – Industrial Buildings	20/50
BUSTector	218	DEHNpatch	211	Selection Chart – Single-family Houses	21/51
Components for Foundation Earth Electrodes	263	DEHNpipe	206	Selection Chart – Type 3 Surge Arrester	103
Components for Ring Equipotential Bonding	263	DEHNprotector	115	Selection guide according to Interface/Signal	135
Condition Monitoring System LifeCheck for BLITZDUCTORconnect	236	DEHNprotector – Combined Adapter	216	SFL Protector	116
Condition Monitoring System with RFID LifeCheck Sensor	237	DEHNrail modular	104	Shield Connection for Cables	233
Connecting Cable for DEHNcube	92	DEHNrail modular, multipole	106	Shield Connection on Anchor Bars	230
Connecting Clamps	262	DEHNrapid LSA	196	Shield Connection on DIN Rails	232
DEHNbloc	45	DEHNrecord Alert	239	SPD+POP+MCB / POP+MCB	75
DEHNbloc Maxi	36	DEHNsafe	110	SPD Test Device	119/242
DEHNbloc Maxi 1 CI 440 / 760 FM	37	DEHNsecure modular	43	SPS Protector	109
DEHNbloc Maxi 440 / 760	39	DEHNshield	27	STC Module	112
DEHNbloc Maxi S	41	DEHNsignal	42	UGKF	222
DEHNbloc modular	34	DEHNsolid	33	VC 280 2	114
DEHNbloc modular for North America	35	DEHNvario	189	V NH / VA NH	100
DEHNbox	219	DEHNvenCI	26	Voltage Controlled Smart Decoupling Device VCSD	251
DEHNcombo	32	DEHNventil modular	22	Voltage Limiting Devices	255
DEHNconnect SD2	185	DPL 10 G3	200	Wiring Accessories DK	121
DEHNconnect SD2 Ex (i)	187	Earthing Busbars, single-row	261	Wiring Accessories STAK	121
DEHNcord	77	Earthing Busbars, two-row	261	Yellow / Line SPD Classes – Symbols	133
DEHNcube	91	Enclosure and Protective Conductor Terminal	234		
DEHNdetect	117	Equipotential Busbars	257		
DEHN Enclosure for Equipotential Bonding	201	EXFS 100 / EXFS 100 KU	248		
DEHNflex	113	EXFS Coaxial Connection Box	250		
DEHNgap	47	EXFS L / EXFS KU	247		
DEHNgap C S	81	FS	227		
DEHNgate	223	Impulse Counter	118		
DEHNguard 5 kA (NL)	64	Insulating Enclosures	122		

Surge Protection
Lightning Protection
Safety Equipment
DEHN protects.

DEHN SE + Co KG
Hans-Dehn-Str. 1
92318 Neumarkt
Germany

Phone +49 9181 906-0
Fax +49 9181 906-1100
sales@dehn.de
www.dehn-international.com



Technical changes, misprints and errors excepted.
The pictures are not binding.